

# **FANUC Series Oi-MODEL F**

**For Lathe System  
OPERATOR'S MANUAL**

- No part of this manual may be reproduced in any form.
- All specifications and designs are subject to change without notice.

The products in this manual are controlled based on Japan's "Foreign Exchange and Foreign Trade Law". The export of from Japan subject to an export license by the government of Japan. Other models in this manual may also be subject to export controls. Further, re-export to another country may be subject to the license of the government of the country from where the product is re-exported. Furthermore, the product may also be controlled by re-export regulations of the United States government.

Should you wish to export or re-export these products, please contact FANUC for advice.

The products in this manual are manufactured under strict quality control. However, when a serious accident or loss is predicted due to a failure of the product, pay careful attention to safety.

In this manual we have tried as much as possible to describe all the various matters. However, we cannot describe all the matters which must not be done, or which cannot be done, because there are so many possibilities.

Therefore, matters which are not especially described as possible in this manual should be regarded as "impossible".

# SAFETY PRECAUTIONS

This section describes the safety precautions related to the use of CNC units.

It is essential that these precautions be observed by users to ensure the safe operation of machines equipped with a CNC unit (all descriptions in this section assume this configuration). Note that some precautions are related only to specific functions, and thus may not be applicable to certain CNC units.

Users must also observe the safety precautions related to the machine, as described in the relevant manual supplied by the machine tool builder. Before attempting to operate the machine or create a program to control the operation of the machine, the operator must become fully familiar with the contents of this manual and relevant manual supplied by the machine tool builder.

## CONTENTS

|  |     |
|--|-----|
| DEFINITION OF WARNING, CAUTION, AND NOTE .....     | s-1 |
| GENERAL WARNINGS AND CAUTIONS .....                | s-2 |
| WARNINGS AND CAUTIONS RELATED TO PROGRAMMING ..... | s-3 |
| WARNINGS AND CAUTIONS RELATED TO HANDLING .....    | s-5 |
| WARNINGS RELATED TO DAILY MAINTENANCE .....        | s-7 |

## DEFINITION OF WARNING, CAUTION, AND NOTE

This manual includes safety precautions for protecting the user and preventing damage to the machine. Precautions are classified into Warning and Caution according to their bearing on safety. Also, supplementary information is described as a Note. Read the Warning, Caution, and Note thoroughly before attempting to use the machine.

### **WARNING**

Applied when there is a danger of the user being injured or when there is a danger of both the user being injured and the equipment being damaged if the approved procedure is not observed.

### **CAUTION**

Applied when there is a danger of the equipment being damaged, if the approved procedure is not observed.

### **NOTE**

The Note is used to indicate supplementary information other than Warning and Caution.

- Read this manual carefully, and store it in a safe place.

## GENERAL WARNINGS AND CAUTIONS

### **WARNING**

- 1 Never attempt to machine a workpiece without first checking the operation of the machine. Before starting a production run, ensure that the machine is operating correctly by performing a trial run using, for example, the single block, feedrate override, or machine lock function or by operating the machine with neither a tool nor workpiece mounted. Failure to confirm the correct operation of the machine may result in the machine behaving unexpectedly, possibly causing damage to the workpiece and/or machine itself, or injury to the user.
- 2 Before operating the machine, thoroughly check the entered data. Operating the machine with incorrectly specified data may result in the machine behaving unexpectedly, possibly causing damage to the workpiece and/or machine itself, or injury to the user.
- 3 Ensure that the specified feedrate is appropriate for the intended operation. Generally, for each machine, there is a maximum allowable feedrate. The appropriate feedrate varies with the intended operation. Refer to the manual provided with the machine to determine the maximum allowable feedrate. If a machine is run at other than the correct speed, it may behave unexpectedly, possibly causing damage to the workpiece and/or machine itself, or injury to the user.
- 4 When using a tool compensation function, thoroughly check the direction and amount of compensation. Operating the machine with incorrectly specified data may result in the machine behaving unexpectedly, possibly causing damage to the workpiece and/or machine itself, or injury to the user.
- 5 The parameters for the CNC and PMC are factory-set. Usually, there is not need to change them. When, however, there is not alternative other than to change a parameter, ensure that you fully understand the function of the parameter before making any change. Failure to set a parameter correctly may result in the machine behaving unexpectedly, possibly causing damage to the workpiece and/or machine itself, or injury to the user.

### **CAUTION**

- 1 Immediately after switching on the power, do not touch any of the keys on the MDI unit until the position display or alarm screen appears on the CNC unit. Some of the keys on the MDI unit are dedicated to maintenance or other special operations. Pressing any of these keys may place the CNC unit in other than its normal state. Starting the machine in this state may cause it to behave unexpectedly.
- 2 The OPERATOR'S MANUAL and programming manual supplied with a CNC unit provide an overall description of the machine's functions, including any optional functions. Note that the optional functions will vary from one machine model to another. Therefore, some functions described in the manuals may not actually be available for a particular model. Check the specification of the machine if in doubt.
- 3 Some functions may have been implemented at the request of the machine-tool builder. When using such functions, refer to the manual supplied by the machine-tool builder for details of their use and any related cautions.

 **CAUTION**

- 4 The liquid-crystal display is manufactured with very precise fabrication technology. Some pixels may not be turned on or may remain on. This phenomenon is a common attribute of LCDs and is not a defect.

**NOTE**

- 1 Programs, parameters, and macro variables are stored in non-volatile memory in the CNC unit. Usually, they are retained even if the power is turned off. Such data may be deleted inadvertently, however, or it may prove necessary to delete all data from non-volatile memory as part of error recovery. To guard against the occurrence of the above, and assure quick restoration of deleted data, backup all vital data, and keep the backup copy in a safe place.
- 2 The number of times to write machining programs to the non-volatile memory is limited.  
You must use "High-speed program management" when registration and the deletion of the machining programs are frequently repeated in such case that the machining programs are automatically downloaded from a personal computer at each machining.  
In "High-speed program management", the program is not saved to the non-volatile memory at registration, modification, or deletion of programs.

## WARNINGS AND CAUTIONS RELATED TO PROGRAMMING

This section covers the major safety precautions related to programming. Before attempting to perform programming, read the supplied OPERATOR'S MANUAL carefully such that you are fully familiar with their contents.

 **WARNING****1 Coordinate system setting**

If a coordinate system is established incorrectly, the machine may behave unexpectedly as a result of the program issuing an otherwise valid move command. Such an unexpected operation may damage the tool, the machine itself, the workpiece, or cause injury to the user.

**2 Positioning by nonlinear interpolation**

When performing positioning by nonlinear interpolation (positioning by nonlinear movement between the start and end points), the tool path must be carefully confirmed before performing programming. Positioning involves rapid traverse. If the tool collides with the workpiece, it may damage the tool, the machine itself, the workpiece, or cause injury to the user.

**3 Function involving a rotation axis**

When programming polar coordinate interpolation or normal-direction (perpendicular) control, pay careful attention to the speed of the rotation axis. Incorrect programming may result in the rotation axis speed becoming excessively high, such that centrifugal force causes the chuck to lose its grip on the workpiece if the latter is not mounted securely. Such mishap is likely to damage the tool, the machine itself, the workpiece, or cause injury to the user.

 **WARNING****4 Inch/metric conversion**

Switching between inch and metric inputs does not convert the measurement units of data such as the workpiece origin offset, parameter, and current position. Before starting the machine, therefore, determine which measurement units are being used. Attempting to perform an operation with invalid data specified may damage the tool, the machine itself, the workpiece, or cause injury to the user.

**5 Constant surface speed control**

When an axis subject to constant surface speed control approaches the origin of the workpiece coordinate system, the spindle speed may become excessively high. Therefore, it is necessary to specify a maximum allowable speed. Specifying the maximum allowable speed incorrectly may damage the tool, the machine itself, the workpiece, or cause injury to the user.

**6 Stroke check**

After switching on the power, perform a manual reference position return as required. Stroke check is not possible before manual reference position return is performed. Note that when stroke check is disabled, an alarm is not issued even if a stroke limit is exceeded, possibly damaging the tool, the machine itself, the workpiece, or causing injury to the user.

**7 Interference check for each path**

Interference check for each path function is performed based on the tool data specified during automatic operation. If the tool specification does not match the tool actually being used, the interference check cannot be made correctly, possibly damaging the tool or the machine itself, or causing injury to the user. After switching on the power, or after selecting a tool post manually, always start automatic operation and specify the tool number of the tool to be used.

**8 Same address command in same block**

The G code or M code including the same address cannot be commanded on the same block. If you use the same address, it may result in the machine behaving unexpectedly, possibly causing damage to the workpiece and/or machine itself, or injury to the user. Command on separate block. (About address P, refer to the appendix "List of functions include address P in the program command")

 **CAUTION****1 Absolute/incremental mode**

If a program created with absolute values is run in incremental mode, or vice versa, the machine may behave unexpectedly.

**2 Plane selection**

If an incorrect plane is specified for circular interpolation, helical interpolation, or a canned cycle, the machine may behave unexpectedly. Refer to the descriptions of the respective functions for details.

**3 Torque limit skip**

Before attempting a torque limit skip, apply the torque limit. If a torque limit skip is specified without the torque limit actually being applied, a move command will be executed without performing a skip.

**4 Programmable mirror image**

Note that programmed operations vary considerably when a programmable mirror image is enabled.

 **CAUTION****5 Compensation function**

If a command based on the machine coordinate system or a reference position return command is issued in compensation function mode, compensation is temporarily canceled, resulting in the unexpected behavior of the machine. Before issuing any of the above commands, therefore, always cancel compensation function mode.

## WARNINGS AND CAUTIONS RELATED TO HANDLING

This section presents safety precautions related to the handling of machine tools. Before attempting to operate your machine, read the supplied OPERATOR'S MANUAL carefully, such that you are fully familiar with their contents.

 **WARNING****1 Manual operation**

When operating the machine manually, determine the current position of the tool and workpiece, and ensure that the movement axis, direction, and feedrate have been specified correctly. Incorrect operation of the machine may damage the tool, the machine itself, the workpiece, or cause injury to the operator.

**2 Manual reference position return**

After switching on the power, perform manual reference position return as required.

If the machine is operated without first performing manual reference position return, it may behave unexpectedly. Stroke check is not possible before manual reference position return is performed.

An unexpected operation of the machine may damage the tool, the machine itself, the workpiece, or cause injury to the user.

**3 Manual numeric command**

When issuing a manual numeric command, determine the current position of the tool and workpiece, and ensure that the movement axis, direction, and command have been specified correctly, and that the entered values are valid.

Attempting to operate the machine with an invalid command specified may damage the tool, the machine itself, the workpiece, or cause injury to the operator.

**4 Manual handle feed**

In manual handle feed, rotating the handle with a large scale factor, such as 100, applied causes the tool and table to move rapidly. Careless handling may damage the tool and/or machine, or cause injury to the user.

**5 Disabled override**

If override is disabled (according to the specification in a macro variable) during threading, rigid tapping, or other tapping, the speed cannot be predicted, possibly damaging the tool, the machine itself, the workpiece, or causing injury to the operator.

**6 Origin/preset operation**

Basically, never attempt an origin/preset operation when the machine is operating under the control of a program. Otherwise, the machine may behave unexpectedly, possibly damaging the tool, the machine itself, the tool, or causing injury to the user.

 **WARNING****7 Workpiece coordinate system shift**

Manual intervention, machine lock, or mirror imaging may shift the workpiece coordinate system. Before attempting to operate the machine under the control of a program, confirm the coordinate system carefully.

If the machine is operated under the control of a program without making allowances for any shift in the workpiece coordinate system, the machine may behave unexpectedly, possibly damaging the tool, the machine itself, the workpiece, or causing injury to the operator.

**8 Software operator's panel and menu switches**

Using the software operator's panel and menu switches, in combination with the MDI unit, it is possible to specify operations not supported by the machine operator's panel, such as mode change, override value change, and jog feed commands.

Note, however, that if the MDI unit keys are operated inadvertently, the machine may behave unexpectedly, possibly damaging the tool, the machine itself, the workpiece, or causing injury to the user.

**9 RESET key**

Pressing the RESET key stops the currently running program. As a result, the servo axes are stopped. However, the RESET key may fail to function for reasons such as an MDI unit problem. So, when the motors must be stopped, use the emergency stop button instead of the RESET key to ensure security.

 **CAUTION****1 Manual intervention**

If manual intervention is performed during programmed operation of the machine, the tool path may vary when the machine is restarted. Before restarting the machine after manual intervention, therefore, confirm the settings of the manual absolute switches, parameters, and absolute/incremental command mode.

**2 Feed hold, override, and single block**

The feed hold, feedrate override, and single block functions can be disabled using custom macro system variable #3004. Be careful when operating the machine in this case.

**3 Dry run**

Usually, a dry run is used to confirm the operation of the machine. During a dry run, the machine operates at dry run speed, which differs from the corresponding programmed feedrate. Note that the dry run speed may sometimes be higher than the programmed feed rate.

**4 Cutter and tool nose radius compensation in MDI mode**

Pay careful attention to a tool path specified by a command in MDI mode, because cutter or tool nose radius compensation is not applied. When a command is entered from the MDI to interrupt in automatic operation in cutter or tool nose radius compensation mode, pay particular attention to the tool path when automatic operation is subsequently resumed. Refer to the descriptions of the corresponding functions for details.



 **CAUTION****5 Program editing**

If the machine is stopped, after which the machining program is edited (modification, insertion, or deletion), the machine may behave unexpectedly if machining is resumed under the control of that program. Basically, do not modify, insert, or delete commands from a machining program while it is in use.

**WARNINGS RELATED TO DAILY MAINTENANCE** **WARNING****1 Memory backup battery replacement**

When replacing the memory backup batteries, keep the power to the machine (CNC) turned on, and apply an emergency stop to the machine. Because this work is performed with the power on and the cabinet open, only those personnel who have received approved safety and maintenance training may perform this work.

When replacing the batteries, be careful not to touch the high-voltage circuits (marked  and fitted with an insulating cover).

Touching the uncovered high-voltage circuits presents an extremely dangerous electric shock hazard.

**NOTE**

The CNC uses batteries to preserve the contents of its memory, because it must retain data such as programs, offsets, and parameters even while external power is not applied.

If the battery voltage drops, a low battery voltage alarm is displayed on the machine operator's panel or screen.

When a low battery voltage alarm is displayed, replace the batteries within a week. Otherwise, the contents of the CNC's memory will be lost.

Refer to the Section "METHOD OF REPLACING BATTERY" in the Chapter, "ROUTINE MAINTENANCE" of OPERATOR'S MANUAL (Common to Lathe/Machining Center System) for details of the battery replacement procedure.

 **WARNING****2 Absolute pulse coder battery replacement**

When replacing the memory backup batteries, keep the power to the machine (CNC) turned on, and apply an emergency stop to the machine. Because this work is performed with the power on and the cabinet open, only those personnel who have received approved safety and maintenance training may perform this work.

When replacing the batteries, be careful not to touch the high-voltage circuits (marked  and fitted with an insulating cover).

Touching the uncovered high-voltage circuits presents an extremely dangerous electric shock hazard.

**NOTE**

The absolute pulse coder uses batteries to preserve its absolute position. If the battery voltage drops, a low battery voltage alarm is displayed on the machine operator's panel or screen.

When a low battery voltage alarm is displayed, replace the batteries within a week. Otherwise, the absolute position data held by the pulse coder will be lost. Refer to the FANUC SERVO MOTOR  $\alpha i$  series Maintenance Manual for details of the battery replacement procedure.

 **WARNING****3 Fuse replacement**

Before replacing a blown fuse, however, it is necessary to locate and remove the cause of the blown fuse.

For this reason, only those personnel who have received approved safety and maintenance training may perform this work.

When replacing a fuse with the cabinet open, be careful not to touch the high-voltage circuits (marked  and fitted with an insulating cover).

Touching an uncovered high-voltage circuit presents an extremely dangerous electric shock hazard.

# TABLE OF CONTENTS

---

|  |            |
|--|------------|
| <b>SAFETY PRECAUTIONS</b> .....                                  | <b>S-1</b> |
| DEFINITION OF WARNING, CAUTION, AND NOTE .....                   | s-1        |
| GENERAL WARNINGS AND CAUTIONS.....                               | s-2        |
| WARNINGS AND CAUTIONS RELATED TO PROGRAMMING .....               | s-3        |
| WARNINGS AND CAUTIONS RELATED TO HANDLING .....                  | s-5        |
| WARNINGS RELATED TO DAILY MAINTENANCE .....                      | s-7        |
| <br>   |            |
| <b>I. GENERAL</b>  |            |
| <b>1 GENERAL</b> .....   | <b>3</b>   |
| 1.1 GENERAL FLOW OF OPERATION OF CNC MACHINE TOOL .....          | 5          |
| 1.2 NOTES ON READING THIS MANUAL.....                            | 6          |
| 1.3 NOTES ON VARIOUS KINDS OF DATA .....                         | 7          |
| <br>   |            |
| <b>II. PROGRAMMING</b>   |            |
| <b>1 GENERAL</b> .....   | <b>11</b>  |
| 1.1 OFFSET .....   | 11         |
| <b>2 PREPARATORY FUNCTION (G FUNCTION)</b> .....                 | <b>12</b>  |
| <b>3 INTERPOLATION FUNCTION</b> .....                            | <b>16</b>  |
| 3.1 POLAR COORDINATE INTERPOLATION (G12.1, G13.1) .....          | 16         |
| 3.2 CONSTANT LEAD THREADING (G32) .....                          | 24         |
| 3.3 VARIABLE LEAD THREADING (G34).....                           | 27         |
| 3.4 CIRCULAR THREADING (G35, G36) .....                          | 28         |
| 3.5 CONTINUOUS THREADING.....                                    | 31         |
| 3.6 MULTIPLE THREADING .....                                     | 32         |
| <b>4 FUNCTIONS TO SIMPLIFY PROGRAMMING</b> .....                 | <b>34</b>  |
| 4.1 CANNED CYCLE (G90, G92, G94) .....                           | 34         |
| 4.1.1 Outer Diameter/Internal Diameter Cutting Cycle (G90) ..... | 35         |
| 4.1.1.1 Straight cutting cycle .....                             | 35         |
| 4.1.1.2 Taper cutting cycle .....                                | 36         |
| 4.1.2 Threading Cycle (G92).....                                 | 37         |
| 4.1.2.1 Straight threading cycle .....                           | 37         |
| 4.1.2.2 Taper threading cycle .....                              | 40         |
| 4.1.3 End Face Turning Cycle (G94) .....                         | 43         |
| 4.1.3.1 Face cutting cycle .....                                 | 43         |
| 4.1.3.2 Taper cutting cycle .....                                | 44         |
| 4.1.4 How to Use Canned Cycles (G90, G92, G94).....              | 45         |
| 4.1.5 Canned Cycle and Tool Nose Radius Compensation .....       | 47         |
| 4.1.6 Restrictions on Canned Cycles.....                         | 48         |
| 4.2 MULTIPLE REPETITIVE CANNED CYCLE (G70-G76) .....             | 51         |
| 4.2.1 Stock Removal in Turning (G71) .....                       | 52         |
| 4.2.2 Stock Removal in Facing (G72) .....                        | 66         |
| 4.2.3 Pattern Repeating (G73).....                               | 70         |
| 4.2.4 Finishing Cycle (G70) .....                                | 74         |

|            |  |            |
|------------|--|------------|
| 4.2.5      | End Face Peck Drilling Cycle (G74).....  | 78         |
| 4.2.6      | Outer Diameter / Internal Diameter Drilling Cycle (G75) .....                            | 80         |
| 4.2.7      | Multiple Threading Cycle (G76).....  | 82         |
| 4.2.8      | Restrictions on Multiple Repetitive Canned Cycle (G70-G76).....                          | 87         |
| <b>4.3</b> | <b>CANNED CYCLE FOR DRILLING.....</b>  | <b>90</b>  |
| 4.3.1      | Front Drilling Cycle (G83)/Side Drilling Cycle (G87) .....                               | 93         |
| 4.3.2      | Front Tapping Cycle (G84) / Side Tapping Cycle (G88).....                                | 97         |
| 4.3.3      | Front Boring Cycle (G85) / Side Boring Cycle (G89) .....                                 | 101        |
| 4.3.4      | Canned Cycle for Drilling Cancel (G80).....  | 102        |
| 4.3.5      | Addition of M Code for Clamp/Unclamp in Canned Cycle for Drilling with.....              | 102        |
| 4.3.6      | Reducing of Waiting Time of Spindle Speed Arrival in the Canned Cycle for Drilling ..... | 103        |
| 4.3.7      | Precautions to be Taken by Operator .....  | 105        |
| <b>4.4</b> | <b>RIGID TAPPING .....</b>   | <b>106</b> |
| 4.4.1      | Front Face Rigid Tapping Cycle (G84) / Side Face Rigid Tapping Cycle (G88) .....         | 107        |
| 4.4.2      | Peck Rigid Tapping Cycle (G84 or G88).....   | 112        |
| 4.4.3      | Canned Cycle Cancel (G80).....   | 116        |
| 4.4.4      | Override during Rigid Tapping .....  | 116        |
| 4.4.4.1    | Extraction override .....  | 116        |
| 4.4.4.2    | Override signal .....  | 117        |
| <b>4.5</b> | <b>CANNED GRINDING CYCLE (FOR GRINDING MACHINE).....</b>                                 | <b>119</b> |
| 4.5.1      | Traverse Grinding Cycle (G71).....   | 121        |
| 4.5.2      | Traverse Direct Constant-Size Grinding Cycle (G72) .....                                 | 123        |
| 4.5.3      | Oscillation Grinding Cycle (G73) .....   | 125        |
| 4.5.4      | Oscillation Direct Constant-Size Grinding Cycle (G74).....                               | 127        |
| <b>4.6</b> | <b>CHAMFERING AND CORNER R.....</b>  | <b>129</b> |
| <b>4.7</b> | <b>MIRROR IMAGE FOR DOUBLE TURRET (G68, G69).....</b>                                    | <b>135</b> |
| <b>4.8</b> | <b>DIRECT DRAWING DIMENSION PROGRAMMING .....</b>  | <b>136</b> |
| <b>5</b>   | <b>COMPENSATION FUNCTION.....</b>  | <b>142</b> |
| <b>5.1</b> | <b>TOOL OFFSET .....</b>   | <b>142</b> |
| 5.1.1      | Tool Geometry Offset and Tool Wear Offset.....   | 142        |
| 5.1.2      | T Code for Tool Offset.....  | 143        |
| 5.1.3      | Tool Selection.....  | 144        |
| 5.1.4      | Offset Number .....  | 144        |
| 5.1.5      | Offset .....   | 144        |
| 5.1.6      | Y-Axis Offset .....  | 147        |
| 5.1.6.1    | Support of arbitrary axes for Y axis offset .....  | 147        |
| 5.1.7      | 2nd Geometry Tool Offset .....   | 148        |
| 5.1.8      | 4th/5th Axis Offset.....   | 150        |
| <b>5.2</b> | <b>OVERVIEW OF TOOL NOSE RADIUS COMPENSATION (G40-G42) .....</b>                         | <b>153</b> |
| 5.2.1      | Imaginary Tool Nose.....   | 153        |
| 5.2.2      | Direction of Imaginary Tool Nose .....   | 155        |
| 5.2.3      | Offset Number and Offset Value.....  | 156        |
| 5.2.4      | Workpiece Position and Move Command.....   | 157        |
| 5.2.5      | Notes on Tool Nose Radius Compensation.....  | 162        |
| <b>5.3</b> | <b>OVERVIEW OF CUTTER COMPENSATION (G40-G42).....</b>                                    | <b>165</b> |
| <b>5.4</b> | <b>DETAILS OF CUTTER OR TOOL NOSE RADIUS COMPENSATION.....</b>                           | <b>171</b> |
| 5.4.1      | Overview .....   | 171        |
| 5.4.2      | Tool Movement in Start-up .....  | 175        |
| 5.4.3      | Tool Movement in Offset Mode.....  | 181        |
| 5.4.4      | Tool Movement in Offset Mode Cancel.....   | 200        |
| 5.4.5      | Prevention of Overcutting Due to Cutter or Tool Nose Radius Compensation .....           | 206        |

|          |  |            |
|----------|--|------------|
| 5.4.6    | Interference Check .....   | 209        |
| 5.4.6.1  | Operation to be performed if an interference is judged to occur .....  | 213        |
| 5.4.6.2  | Interference check alarm function .....                                | 213        |
| 5.4.6.3  | Interference check avoidance function .....                            | 215        |
| 5.4.7    | Cutter or Tool Nose Radius Compensation for Input from MDI .....       | 220        |
| 5.5      | VECTOR RETENTION (G38) .....   | 222        |
| 5.6      | CORNER CIRCULAR INTERPOLATION (G39) .....                              | 223        |
| 5.7      | EXTENDED TOOL SELECTION .....  | 225        |
| 5.8      | AUTOMATIC TOOL OFFSET (G36, G37) .....                                 | 228        |
| <b>6</b> | <b>MEMORY OPERATION USING Series 10/11 FORMAT .....</b>                | <b>231</b> |
| 6.1      | ADDRESSES AND SPECIFIED RANGE FOR Series 10/11 PROGRAM<br>FORMAT ..... | 231        |
| 6.2      | SUBPROGRAM CALLING .....   | 231        |
| 6.3      | CANNED CYCLE .....   | 232        |
| 6.3.1    | Outer Diameter/Internal Diameter Cutting Cycle (G90) .....             | 233        |
| 6.3.1.1  | Straight cutting cycle .....   | 233        |
| 6.3.1.2  | Taper cutting cycle .....  | 234        |
| 6.3.2    | Threading Cycle (G92) .....  | 235        |
| 6.3.2.1  | Straight threading cycle .....   | 235        |
| 6.3.2.2  | Taper threading cycle .....  | 238        |
| 6.3.3    | End Face Turning Cycle (G94) .....                                     | 241        |
| 6.3.3.1  | Face cutting cycle .....   | 241        |
| 6.3.3.2  | Taper cutting cycle .....  | 242        |
| 6.3.4    | How to Use Canned Cycles .....   | 244        |
| 6.3.5    | Canned Cycle and Tool Nose Radius Compensation .....                   | 245        |
| 6.3.6    | Restrictions on Canned Cycles .....                                    | 246        |
| 6.4      | MULTIPLE REPETITIVE CANNED CYCLE .....                                 | 249        |
| 6.4.1    | Stock Removal in Turning (G71) .....                                   | 250        |
| 6.4.2    | Stock Removal in Facing (G72) .....                                    | 260        |
| 6.4.3    | Pattern Repeating (G73) .....  | 264        |
| 6.4.4    | Finishing Cycle (G70) .....  | 267        |
| 6.4.5    | End Face Peck Drilling Cycle (G74) .....                               | 271        |
| 6.4.6    | Outer Diameter / Internal Diameter Drilling Cycle (G75) .....          | 273        |
| 6.4.7    | Multiple Threading Cycle (G76) .....                                   | 275        |
| 6.4.8    | Restrictions on Multiple Repetitive Canned Cycle .....                 | 281        |
| 6.5      | CANNED CYCLE FOR DRILLING .....  | 283        |
| 6.5.1    | High-speed Peck Drilling Cycle (G83.1) .....                           | 287        |
| 6.5.2    | Drilling Cycle, Spot Drilling Cycle (G81) .....                        | 288        |
| 6.5.3    | Drilling Cycle, Counter Boring (G82) .....                             | 289        |
| 6.5.4    | Peck Drilling Cycle (G83) .....  | 290        |
| 6.5.5    | Tapping Cycle (G84) .....  | 292        |
| 6.5.6    | Tapping Cycle (G84.2) .....  | 293        |
| 6.5.7    | Boring Cycle (G85) .....   | 295        |
| 6.5.8    | Boring Cycle (G89) .....   | 296        |
| 6.5.9    | Canned Cycle for Drilling Cancel (G80) .....                           | 297        |
| 6.5.10   | Precautions to be Taken by Operator .....                              | 297        |
| <b>7</b> | <b>AXIS CONTROL FUNCTIONS .....</b>                                    | <b>298</b> |
| 7.1      | POLYGON TURNING (G50.2, G51.2) .....                                   | 298        |
| <b>8</b> | <b>MULTI-PATH CONTROL FUNCTION .....</b>                               | <b>303</b> |
| 8.1      | BALANCE CUT (G68, G69) .....   | 303        |

### III. OPERATION

|          |  |            |
|----------|--|------------|
| <b>1</b> | <b>DATA INPUT/OUTPUT .....</b>   | <b>307</b> |
| 1.1      | INPUT/OUTPUT ON EACH SCREEN .....  | 307        |
| 1.1.1    | Inputting and Outputting Y-axis Offset Data .....  | 307        |
| 1.1.1.1  | Inputting Y-axis offset data .....   | 307        |
| 1.1.1.2  | Outputting Y-axis Offset Data .....  | 308        |
| 1.1.2    | Inputting and Outputting Tool Offset / 2nd Geometry Data .....   | 309        |
| 1.1.2.1  | Inputting tool offset / 2nd geometry data .....  | 309        |
| 1.1.2.2  | Outputting tool offset / 2nd geometry data .....   | 310        |
| 1.1.3    | Inputting and Outputting 4th/5th Axis Offset Data .....  | 311        |
| 1.1.3.1  | Inputting 4th/5th axis offset data .....   | 311        |
| 1.1.3.2  | Outputting 4th/5th Axis Offset Data .....  | 312        |
| 1.2      | INPUT/OUTPUT ON THE ALL IO SCREEN .....  | 314        |
| 1.2.1    | Inputting and Outputting Y-axis Offset Data .....  | 315        |
| 1.2.2    | Inputting and Outputting Tool Offset / 2nd Geometry Tool Offset .....  | 316        |
| <b>2</b> | <b>SETTING AND DISPLAYING DATA .....</b>   | <b>319</b> |
| 2.1      | SCREENS DISPLAYED BY FUNCTION KEY  ..... | 319        |
| 2.1.1    | Setting and Displaying the Tool Offset Value .....   | 319        |
| 2.1.2    | Direct Input of Tool Offset Value .....  | 324        |
| 2.1.3    | Direct Input of Tool Offset Value Measured B .....   | 327        |
| 2.1.4    | Counter Input of Offset value .....  | 329        |
| 2.1.5    | Setting the Workpiece Coordinate System Shift Value .....  | 330        |
| 2.1.6    | Setting Tool Offset / 2nd Geometry Tool Offset Values .....  | 334        |
| 2.1.7    | Setting the Y-Axis Offset .....  | 337        |
| 2.1.8    | Setting the 4th/5th Axis Offset .....  | 343        |
| 2.1.9    | Chuck and Tail Stock Barriers .....  | 348        |

### APPENDIX

|          |  |            |
|----------|--|------------|
| <b>A</b> | <b>PARAMETERS .....</b>  | <b>359</b> |
| A.1      | DESCRIPTION OF PARAMETERS .....  | 359        |
| A.2      | DATA TYPE .....  | 408        |
| A.3      | STANDARD PARAMETER SETTING TABLES .....                                      | 409        |
| <b>B</b> | <b>LIST OF FUNCTIONS INCLUDE ADDRESS P IN THE PROGRAM<br/>COMMAND .....</b>  | <b>410</b> |
| B.1      | LIST OF FUNCTIONS INCLUDE ADDRESS P IN THE ARGUMENT OF<br>G CODE .....       | 410        |
| B.2      | LIST OF FUNCTIONS INCLUDE ADDRESS P IN THE ARGUMENT OF<br>M AND S CODE ..... | 414        |

# **I. GENERAL**





# 1 GENERAL

This manual consists of the following parts:

## About this manual

### I. GENERAL

Describes chapter organization, applicable models, related manuals, and notes for reading this manual.

### II. PROGRAMMING

Describes each function: Format used to program functions in the NC language, characteristics, and restrictions.

### III. OPERATION

Describes the manual operation and automatic operation of a machine, procedures for inputting and outputting data, and procedures for editing a program.

### APPENDIX

Lists parameters.

#### NOTE

- 1 This manual describes the functions that can operate in the CNC model for lathe system (path control type). For other functions not specific to the lathe system, refer to the Operator's Manual (Common to Lathe System/Machining Center System) (B-64604EN).
- 2 This manual does not detail the parameters not mentioned in the text. For details of those parameters, refer to the Parameter Manual (B-64610EN).  
Parameters are used to set functions and operating conditions of a CNC machine tool, and frequently-used values in advance. Usually, the machine tool builder factory-sets parameters so that the user can use the machine tool easily.
- 3 This manual describes not only basic functions but also optional functions. Look up the options incorporated into your system in the manual written by the machine tool builder.

## Applicable models

This manual describes the models indicated in the table below.

In the text, the abbreviations indicated below may be used.

| Model name         | Abbreviation |             |           |
|--------------------|--------------|-------------|-----------|
| FANUC Series 0i-TF | 0i-TF        | Series 0i-F | Series 0i |

#### NOTE

- 1 For explanatory purposes, the following descriptions may be used according to the CNC model :
  - 0i-TF : Lathe system (T series)
- 2 For the FANUC Series 0i-MODEL F, parameters need to be set to enable or disable some basic functions. For these parameters, refer to "PARAMETERS OF 0i-F BASIC FUNCTIONS" in the PARAMETER MANUAL (B-64610EN).

## Special symbols

This manual uses the following symbols:

### - IP

Indicates a combination of axes such as X\_ Y\_ Z\_

In the underlined position following each address, a numeric value such as a coordinate value is placed (used in PROGRAMMING.).

### - ;

Indicates the end of a block. It actually corresponds to the ISO code LF or EIA code CR.

## Related manuals of Series 0i- MODEL F

The following table lists the manuals related to Series 0i-F. This manual is indicated by an asterisk(\*).

Table 1 (a) Related manuals

| Manual name  | Specification number |   |
|--|----------------------|---|
| DESCRIPTIONS   | B-64602EN            |   |
| CONNECTION MANUAL (HARDWARE)   | B-64603EN            |   |
| CONNECTION MANUAL (FUNCTION)   | B-64603EN-1          |   |
| OPERATOR'S MANUAL (Common to Lathe System/Machining Center System)                       | B-64604EN            |   |
| OPERATOR'S MANUAL (For Lathe System)   | B-64604EN-1          | * |
| OPERATOR'S MANUAL (For Machining Center System)  | B-64604EN-2          |   |
| MAINTENANCE MANUAL   | B-64605EN            |   |
| PARAMETER MANUAL   | B-64610EN            |   |
| <b>Programming</b>   |                      |   |
| Macro Executor PROGRAMMING MANUAL  | B-63943EN-2          |   |
| Macro Compiler PROGRAMMING MANUAL  | B-66263EN            |   |
| C Language Executor PROGRAMMING MANUAL   | B-63943EN-3          |   |
| <b>PMC</b>   |                      |   |
| PMC PROGRAMMING MANUAL   | B-64513EN            |   |
| <b>Network</b>   |                      |   |
| PROFIBUS-DP Board CONNECTION MANUAL  | B-63993EN            |   |
| Fast Ethernet / Fast Data Server OPERATOR'S MANUAL                                       | B-64014EN            |   |
| DeviceNet Board CONNECTION MANUAL  | B-64043EN            |   |
| CC-Link Board CONNECTION MANUAL  | B-64463EN            |   |
| <b>Operation guidance function</b>   |                      |   |
| MANUAL GUIDE <i>i</i> (Common to Lathe System/Machining Center System) OPERATOR'S MANUAL | B-63874EN            |   |
| MANUAL GUIDE <i>i</i> (For Machining Center System) OPERATOR'S MANUAL                    | B-63874EN-2          |   |
| MANUAL GUIDE <i>i</i> (Set-up Guidance Functions) OPERATOR'S MANUAL                      | B-63874EN-1          |   |
| MANUAL GUIDE 0 <i>i</i> OPERATOR'S MANUAL  | B-64434EN            |   |
| TURN MATE <i>i</i> OPERATOR'S MANUAL   | B-64254EN            |   |
| <b>Dual Check Safety</b>   |                      |   |
| Dual Check Safety CONNECTION MANUAL  | B-64483EN-2          |   |

## Related manuals of SERVO MOTOR $\alpha i/\beta i$ series

The following table lists the manuals related to SERVO MOTOR  $\alpha i/\beta i$  series

Table 1 (b) Related manuals

| Manual name   | Specification number |
|---|----------------------|
| FANUC AC SERVO MOTOR $\alpha i$ series DESCRIPTIONS   | B-65262EN            |
| FANUC AC SPINDLE MOTOR $\alpha i$ series DESCRIPTIONS | B-65272EN            |
| FANUC AC SERVO MOTOR $\beta i$ series DESCRIPTIONS    | B-65302EN            |
| FANUC AC SPINDLE MOTOR $\beta i$ series DESCRIPTIONS  | B-65312EN            |

| Manual name   | Specification number |
|---|----------------------|
| FANUC SERVO AMPLIFIER $\alpha i$ series DESCRIPTIONS  | B-65282EN            |
| FANUC SERVO AMPLIFIER $\beta i$ series DESCRIPTIONS   | B-65322EN            |
| FANUC SERVO MOTOR $\alpha i s$ series<br>FANUC SERVO MOTOR $\alpha i$ series<br>FANUC AC SPINDLE MOTOR $\alpha i$ series<br>FANUC SERVO AMPLIFIER $\alpha i$ series<br>MAINTENANCE MANUAL | B-65285EN            |
| FANUC SERVO MOTOR $\beta i s$ series<br>FANUC AC SPINDLE MOTOR $\beta i$ series<br>FANUC SERVO AMPLIFIER $\beta i$ series<br>MAINTENANCE MANUAL   | B-65325EN            |
| FANUC AC SERVO MOTOR $\alpha i$ series<br>FANUC AC SERVO MOTOR $\beta i$ series<br>FANUC LINEAR MOTOR LiS series<br>FANUC SYNCHRONOUS BUILT-IN SERVO MOTOR DiS series<br>PARAMETER MANUAL | B-65270EN            |
| FANUC AC SPINDLE MOTOR $\alpha i/\beta i$ series,<br>BUILT-IN SPINDLE MOTOR Bi series<br>PARAMETER MANUAL   | B-65280EN            |

The above servo motors and the corresponding spindles can be connected to the CNC covered in this manual. In the  $\alpha i$  SV,  $\alpha i$  SP,  $\alpha i$  PS, and  $\beta i$  SV series, however, they can be connected only to 30 *i*-B-compatible versions. In the  $\beta i$  SVSP series, they cannot be connected.

This manual mainly assumes that the FANUC SERVO MOTOR  $\alpha i$  series of servo motor is used. For servo motor and spindle information, refer to the manuals for the servo motor and spindle that are actually connected.

## 1.1 GENERAL FLOW OF OPERATION OF CNC MACHINE TOOL

When machining the part using the CNC machine tool, first prepare the program, then operate the CNC machine by using the program.

- (1) First, prepare the program from a part drawing to operate the CNC machine tool.  
How to prepare the program is described in the Part II, "PROGRAMMING".
- (2) The program is to be read into the CNC system. Then, mount the workpieces and tools on the machine, and operate the tools according to the programming. Finally, execute the machining actually.

How to operate the CNC system is described in the Part III, "OPERATION".

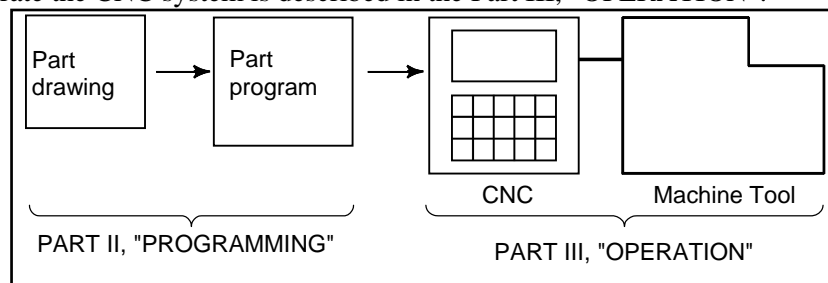

Before the actual programming, make the machining plan for how to machine the part.  
(Machining plan)

1. Determination of workpieces machining range
2. Method of mounting workpieces on the machine tool
3. Machining sequence in every cutting process
4. Cutting tools and cutting conditions

Decide the cutting method in every cutting process.

| Cutting process                                      | 1                | 2                      | 3        |
|--|------------------|------------------------|----------|
|  | End face cutting | Outer diameter cutting | Grooving |
| 1. Cutting method :<br>Rough<br>Semi<br>Finish       |                  |                        |          |
| 2. Cutting tools                                     |                  |                        |          |
| 3. Cutting conditions :<br>Feedrate<br>Cutting depth |                  |                        |          |
| 4. Tool path   |                  |                        |          |

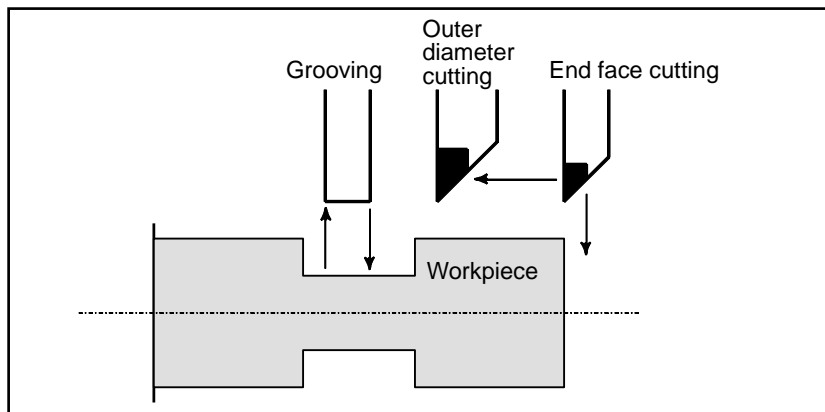

Prepare the program of the tool path and cutting condition according to the workpiece figure, for each cutting.

## 1.2 NOTES ON READING THIS MANUAL

### ⚠ CAUTION

- 1 The function of an CNC machine tool system depends not only on the CNC, but on the combination of the machine tool, its magnetic cabinet, the servo system, the CNC, the operator's panels, etc. It is too difficult to describe the function, programming, and operation relating to all combinations. This manual generally describes these from the stand-point of the CNC. So, for details on a particular CNC machine tool, refer to the manual issued by the machine tool builder, which should take precedence over this manual.
- 2 In the header field of each page of this manual, a chapter title is indicated so that the reader can reference necessary information easily.  
By finding a desired title first, the reader can reference necessary parts only.
- 3 This manual describes as many reasonable variations in equipment usage as possible. It cannot address every combination of features, options and commands that should not be attempted.  
If a particular combination of operations is not described, it should not be attempted.

## 1.3 NOTES ON VARIOUS KINDS OF DATA

---

### CAUTION

- 1 Machining programs, parameters, offset data, etc. are stored in the CNC unit internal non-volatile memory. In general, these contents are not lost by the switching ON/OFF of the power. However, it is possible that a state can occur where precious data stored in the non-volatile memory has to be deleted, because of deletions from a maloperation, or by a failure restoration. In order to restore rapidly when this kind of mishap occurs, it is recommended that you create a copy of the various kinds of data beforehand.
- 2 The number of times to write machining programs to the non-volatile memory is limited.  
You must use "High-speed program management" when registration and the deletion of the machining programs are frequently repeated in such case that the machining programs are automatically downloaded from a personal computer at each machining.  
In "High-speed program management", the program is not saved to the non-volatile memory at registration, modification, or deletion of programs.



## **II. PROGRAMMING**





# 1 GENERAL

Chapter 1, "GENERAL", consists of the following sections:

|                  |    |
|------------------|----|
| 1.1 OFFSET ..... | 11 |
|------------------|----|

## 1.1 OFFSET

### Explanation

#### - Tool offset

Usually, several tools are used for machining one workpiece. The tools have different tool length. It is very troublesome to change the program in accordance with the tools.

Therefore, the length of each tool used should be measured in advance. By setting the difference between the length of the standard tool and the length of each tool in the CNC (see Chapter, "Setting and Displaying Data" in the OPERATOR'S MANUAL (Common to Lathe System/Machining Center System)), machining can be performed without altering the program even when the tool is changed. This function is called tool offset.

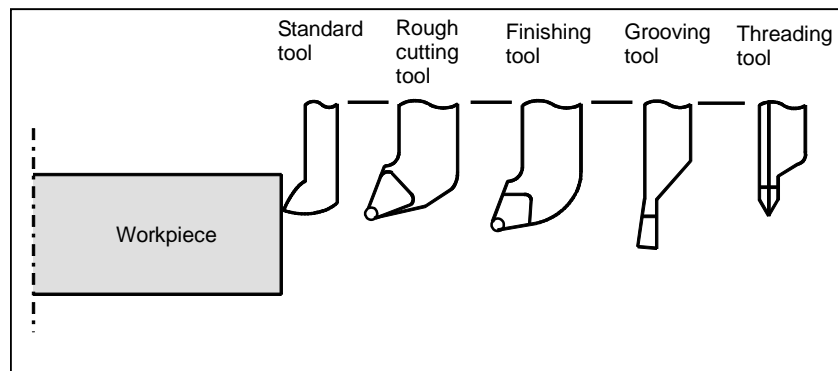

Fig. 1.1 (a) Tool offset

# 2 PREPARATORY FUNCTION (G FUNCTION)

A number following address G determines the meaning of the command for the concerned block. G codes are divided into the following two types.

| Type            | Meaning  |
|-----------------|--|
| One-shot G code | The G code is effective only in the block in which it is specified.          |
| Modal G code    | The G code is effective until another G code of the same group is specified. |

(Example)

G01 and G00 are modal G codes in group 01.

```

G01   X_ ; }
      Z_ ; } G01 is effective in this range.
      X_ ; }
G00   Z_ ; }
      X_ ; } G00 is effective in this range.
G01   X_ ;
      :
    
```

There are three G code systems in the lathe system : A,B, and C (Table 2 (a)). Select a G code system using bits 6 (GSB) and 7 (GSC) parameter No. 3401. Generally, OPERATOR'S MANUAL describes the use of G code system A, except when the described item can use only G code system B or C. In such cases, the use of G code system B or C is described.

## Explanation

- When the clear state (bit 6 (CLR) of parameter No. 3402) is set at power-up or reset, the modal G codes are placed in the states described below.
  - The modal G codes are placed in the states marked with  as indicated in Table.
  - G20 and G21 remain unchanged when the clear state is set at power-up or reset.
  - Which status G22 or G23 at power on is set by bit 7 (G23) of parameter No. 3402. However, G22 and G23 remain unchanged when the clear state is set at reset.
  - The user can select G00 or G01 by setting bit 0 (G01) of parameter No. 3402.
  - The user can select G90 or G91 by setting bit 3 (G91) of parameter No. 3402.  
When G code system B or C is used in the lathe system, setting bit 3 (G91) of parameter No. 3402 determines which code, either G90 or G91, is effective.
- G codes other than G10 and G11 are one-shot G codes.
- When a G code not listed in the G code list is specified, or a G code that has no corresponding option is specified, alarm PS0010, "IMPROPER G-CODE" occurs.
- Multiple G codes can be specified in the same block if each G code belongs to a different group. If multiple G codes that belong to the same group are specified in the same block, only the last G code specified is valid.
- If a G code belonging to group 01 is specified in a for drilling, the canned cycle for drilling is cancelled. This means that the same state set by specifying G80 is set. Note that the G codes in group 01 are not affected by a G code specifying a canned cycle.
- When G code system A is used, absolute or incremental programming is specified not by a G code (G90/G91) but by an address word (X/U, Z/W, C/H, Y/V). Only the initial level is provided at the return point of the canned cycle for drilling..
- G codes are indicated by group.

Table 2 (a) G code list

| G code system   |                 |                 | Group  | Function   |  |
|-----------------|-----------------|-----------------|--|--|--|
| A               | B               | C               |  |  |  |
| G00             | G00             | G00             | 01   | Positioning (Rapid traverse)   |  |
| G01             | G01             | G01             |  | Linear interpolation (Cutting feed)  |  |
| G02             | G02             | G02             |  | Circular interpolation CW or helical interpolation CW  |  |
| G03             | G03             | G03             |  | Circular interpolation CCW or helical interpolation CCW  |  |
| G04             | G04             | G04             |  | Dwell  |  |
| G04.1           | G04.1           | G04.1           | 00   | G code preventing buffering  |  |
| G05.1           | G05.1           | G05.1           |  | AI contour control   |  |
| G05.4           | G05.4           | G05.4           |  | HRV3 on/off  |  |
| G07.1<br>(G107) | G07.1<br>(G107) | G07.1<br>(G107) |  | Cylindrical interpolation  |  |
| G08             | G08             | G08             |  | AI contour control (advanced preview control compatible command)   |  |
| G09             | G09             | G09             |  | Exact stop   |  |
| G10             | G10             | G10             |  | Programmable data input  |  |
| G10.6           | G10.6           | G10.6           |  | Tool retract and recover   |  |
| G11             | G11             | G11             |  | Programmable data input mode cancel  |  |
| G12.1<br>(G112) | G12.1<br>(G112) | G12.1<br>(G112) |  | 21   | Polar coordinate interpolation mode        |
| G13.1<br>(G113) | G13.1<br>(G113) | G13.1<br>(G113) |  |  | Polar coordinate interpolation cancel mode |
| G17             | G17             | G17             |  | 16   | XpYp plane selection                       |
| G18             | G18             | G18             |  |  | ZpXp plane selection                       |
| G19             | G19             | G19             |  |  | YpZp plane selection                       |
| G20             | G20             | G70             | 06   | Input in inch  |  |
| G21             | G21             | G71             |  | Input in mm  |  |
| G22             | G22             | G22             | 09   | Stored stroke check function on  |  |
| G23             | G23             | G23             |  | Stored stroke check function off   |  |
| G25             | G25             | G25             | 08   | Spindle speed fluctuation detection off  |  |
| G26             | G26             | G26             |  | Spindle speed fluctuation detection on   |  |
| G27             | G27             | G27             | 00   | Reference position return check  |  |
| G28             | G28             | G28             |  | Return to reference position   |  |
| G28.2           | G28.2           | G28.2           |  | In-position check disable reference position return  |  |
| G29             | G29             | G29             |  | Movement from reference position   |  |
| G30             | G30             | G30             |  | 2nd, 3rd and 4th reference position return   |  |
| G30.2           | G30.2           | G30.2           |  | In-position check disable 2nd, 3rd, or 4th reference position return   |  |
| G31             | G31             | G31             |  | Skip function  |  |
| G32             | G33             | G33             |  | Threading  |  |
| G34             | G34             | G34             |  | Variable lead threading  |  |
| G35             | G35             | G35             |  | Circular threading CW  |  |
| G36             | G36             | G36             | 01   | Circular threading CCW (When bit 3 (G36) of parameter No. 3405 is set to 1) or Automatic tool offset (X axis) (When bit 3 (G36) of parameter No. 3405 is set to 0) |  |
| G37             | G37             | G37             |  | Automatic tool offset (Z axis) (When bit 3 (G36) of parameter No. 3405 is set to 0)  |  |
| G37.1           | G37.1           | G37.1           |  | Automatic tool offset (X axis) (When bit 3 (G36) of parameter No. 3405 is set to 1)  |  |
| G37.2           | G37.2           | G37.2           |  | Automatic tool offset (Z axis) (When bit 3 (G36) of parameter No. 3405 is set to 1)  |  |
| G38             | G38             | G38             |  | Tool radius/tool nose radius compensation: with vector held  |  |
| G39             | G39             | G39             | Tool radius/tool nose radius compensation: corner rounding interpolation |  |  |

2. PREPARATORY FUNCTION  
(G FUNCTION)

PROGRAMMING

B-64604EN-1/01

Table 2 (a) G code list

| G code system    |                  |                  | Group                              | Function   |
|------------------|------------------|------------------|------------------------------------|--|
| A                | B                | C                |                                    |  |
| G40              | G40              | G40              | 07                                 | Tool radius/tool nose radius compensation : cancel                                       |
| G41              | G41              | G41              |                                    | Tool radius/tool nose radius compensation : left   |
| G42              | G42              | G42              |                                    | Tool radius/tool nose radius compensation : right  |
| G43.7<br>(G44.7) | G43.7<br>(G44.7) | G43.7<br>(G44.7) |                                    | Tool offset<br>(Bit 3 (TCT) of parameter No. 5040 must be "1".)                          |
| G49<br>(G49.1)   | G49<br>(G49.1)   | G49<br>(G49.1)   |                                    | Tool length compensation cancel<br>(Bit 3 (TCT) of parameter No. 5040 must be "1".)      |
| G50              | G92              | G92              |                                    | 00   |
| G50.3            | G92.1            | G92.1            | Workpiece coordinate system preset |  |
| G50.1            | G50.1            | G50.1            | 22                                 | Programmable mirror image cancel   |
| G51.1            | G51.1            | G51.1            |                                    | Programmable mirror image  |
| G50.2<br>(G250)  | G50.2<br>(G250)  | G50.2<br>(G250)  | 20                                 | Polygon turning cancel   |
| G51.2<br>(G251)  | G51.2<br>(G251)  | G51.2<br>(G251)  |                                    | Polygon turning  |
| G50.4            | G50.4            | G50.4            | 00                                 | Cancel synchronous control   |
| G50.5            | G50.5            | G50.5            |                                    | Cancel composite control   |
| G50.6            | G50.6            | G50.6            |                                    | Cancel superimposed control  |
| G51.4            | G51.4            | G51.4            |                                    | Start synchronous control  |
| G51.5            | G51.5            | G51.5            |                                    | Start composite control  |
| G51.6            | G51.6            | G51.6            |                                    | Start superimposed control   |
| G52              | G52              | G52              |                                    | Local coordinate system setting  |
| G53              | G53              | G53              |                                    | Machine coordinate system setting  |
| G54<br>(G54.1)   | G54<br>(G54.1)   | G54<br>(G54.1)   | 14                                 | Workpiece coordinate system 1 selection  |
| G55              | G55              | G55              |                                    | Workpiece coordinate system 2 selection  |
| G56              | G56              | G56              |                                    | Workpiece coordinate system 3 selection  |
| G57              | G57              | G57              |                                    | Workpiece coordinate system 4 selection  |
| G58              | G58              | G58              |                                    | Workpiece coordinate system 5 selection  |
| G59              | G59              | G59              |                                    | Workpiece coordinate system 6 selection  |
| G61              | G61              | G61              | 15                                 | Exact stop mode  |
| G62              | G62              | G62              |                                    | Automatic corner override mode   |
| G63              | G63              | G63              |                                    | Tapping mode   |
| G64              | G64              | G64              |                                    | Cutting mode   |
| G65              | G65              | G65              | 00                                 | Macro call   |
| G66              | G66              | G66              | 12                                 | Macro modal call A   |
| G66.1            | G66.1            | G66.1            |                                    | Macro modal call B   |
| G67              | G67              | G67              |                                    | Macro modal call A/B cancel  |
| G68              | G68              | G68              | 04                                 | Mirror image on for double turret or balance cutting mode                                |
| G68.1            | G68.1            | G68.1            | 17                                 | Coordinate system rotation start or 3-dimensional coordinate system conversion mode on   |
| G69              | G69              | G69              | 04                                 | Mirror image off for double turret or balance cutting mode cancel                        |
| G69.1            | G69.1            | G69.1            | 17                                 | Coordinate system rotation cancel or 3-dimensional coordinate system conversion mode off |

Table 2 (a) G code list

| G code system |       |       | Group                                    | Function  |
|---------------|-------|-------|--|---|
| A             | B     | C     |  |   |
| G70           | G70   | G72   | 00                                       | Finishing cycle   |
| G71           | G71   | G73   |  | Stock removal in turning                                |
| G72           | G72   | G74   |  | Stock removal in facing                                 |
| G73           | G73   | G75   |  | Pattern repeating cycle                                 |
| G74           | G74   | G76   |  | End face peck drilling cycle                            |
| G75           | G75   | G77   |  | Outer diameter/internal diameter drilling cycle         |
| G76           | G76   | G78   |  | Multiple-thread cutting cycle                           |
| G71           | G71   | G72   |  | 01  |
| G72           | G72   | G73   | Traverse direct sizing/grinding cycle    |   |
| G73           | G73   | G74   | Oscillation grinding cycle               |   |
| G74           | G74   | G75   | Oscillation direct sizing/grinding cycle |   |
| G80           | G80   | G80   | 10                                       | Canned cycle cancel for drilling                        |
| G81.1         | G81.1 | G81.1 | 00                                       | High precision oscillation function                     |
| G81           | G81   | G81   | 10                                       | Spot drilling (FS10/11-T format)                        |
| G82           | G82   | G82   |  | Counter boring (FS10/11-T format)                       |
| G83           | G83   | G83   |  | Cycle for face drilling                                 |
| G83.1         | G83.1 | G83.1 |  | High-speed peck drilling cycle (FS10/11-T format)       |
| G83.5         | G83.5 | G83.5 |  | High-speed peck drilling cycle                          |
| G83.6         | G83.6 | G83.6 |  | Peck drilling cycle                                     |
| G84           | G84   | G84   |  | Cycle for face tapping                                  |
| G84.2         | G84.2 | G84.2 |  | Rigid tapping cycle (FS10/11-T format)                  |
| G85           | G85   | G85   |  | Cycle for face boring                                   |
| G87           | G87   | G87   |  | Cycle for side drilling                                 |
| G87.5         | G87.5 | G87.5 |  | High-speed peck drilling cycle                          |
| G87.6         | G87.6 | G87.6 |  | Peck drilling cycle                                     |
| G88           | G88   | G88   |  | Cycle for side tapping                                  |
| G89           | G89   | G89   |  | Cycle for side boring                                   |
| G90           | G77   | G20   | 01                                       | Outer diameter/internal diameter cutting cycle          |
| G92           | G78   | G21   |  | Threading cycle   |
| G94           | G79   | G24   |  | End face turning cycle                                  |
| G91.1         | G91.1 | G91.1 | 00                                       | Maximum specified incremental amount check              |
| G96           | G96   | G96   | 02                                       | Constant surface speed control                          |
| G97           | G97   | G97   |  | Constant surface speed control cancel                   |
| G96.1         | G96.1 | G96.1 | 00                                       | Spindle indexing execution (waiting for completion)     |
| G96.2         | G96.2 | G96.2 |  | Spindle indexing execution (not waiting for completion) |
| G96.3         | G96.3 | G96.3 |  | Spindle indexing completion check                       |
| G96.4         | G96.4 | G96.4 |  | SV speed control mode ON                                |
| G98           | G94   | G94   | 05                                       | Feed per minute   |
| G99           | G95   | G95   |  | Feed per revolution                                     |
| -             | G90   | G90   | 03                                       | Absolute programming                                    |
| -             | G91   | G91   |  | Incremental programming                                 |
| -             | G98   | G98   | 11                                       | Canned cycle : return to initial level                  |
| -             | G99   | G99   |  | Canned cycle : return to R point level                  |

# 3 INTERPOLATION FUNCTION

Chapter 3, "INTERPOLATION FUNCTION", consists of the following sections:

|     |   |    |
|-----|---|----|
| 3.1 | POLAR COORDINATE INTERPOLATION (G12.1, G13.1) | 16 |
| 3.2 | CONSTANT LEAD THREADING (G32)                 | 24 |
| 3.3 | VARIABLE LEAD THREADING (G34)                 | 27 |
| 3.4 | CIRCULAR THREADING (G35, G36)                 | 28 |
| 3.5 | CONTINUOUS THREADING                          | 31 |
| 3.6 | MULTIPLE THREADING                            | 32 |

## 3.1 POLAR COORDINATE INTERPOLATION (G12.1, G13.1)

### Overview

Polar coordinate interpolation is a function that exercises contour control in converting a command programmed in a Cartesian coordinate system to the movement of a linear axis (movement of a tool) and the movement of a rotary axis (rotation of a workpiece). This function is useful for grinding a cam shaft.

#### NOTE

When bit 5 (NPI) of parameter No.8137 is 0, this function can be used.

### Format

|   |  |
|---|--|
| <b>G12.1;</b>                               | Starts polar coordinate interpolation mode (enables polar coordinate interpolation).   |
| .....                                       | } Specify linear or circular interpolation using coordinates in a Cartesian coordinate system consisting of a linear axis and rotary axis (hypothetical axis). |
| .....                                       |  |
| <b>G13.1;</b>                               | Polar coordinate interpolation mode is cancelled (for not performing polar coordinate interpolation).  |
| Specify G12.1 and G13.1 in Separate Blocks. |  |

### Explanation

#### - Polar coordinate interpolation mode (G12.1)

The axes of polar coordinate interpolation (linear axis and rotary axis) should be specified in advance, with corresponding parameters. Specifying G12.1 places the system in the polar coordinate interpolation mode, and selects a plane (called the polar coordinate interpolation plane) formed by one linear axis and a hypothetical axis intersecting the linear axis at right angles. The linear axis is called the first axis of the plane, and the hypothetical axis is called the second axis of the plane. Polar coordinate interpolation is performed in this plane.

In the polar coordinate interpolation mode, both linear interpolation and circular interpolation can be specified by absolute or incremental programming.

Tool radius compensation can also be performed. The polar coordinate interpolation is performed for a path obtained after tool radius compensation.

The tangential velocity in the polar coordinate interpolation plane (Cartesian coordinate system) is specified as the feedrate, using F.

#### - Polar coordinate interpolation cancel mode (G13.1)

Specifying G13.1 cancels the polar coordinate interpolation mode.

### - Polar coordinate interpolation plane

G12.1 starts the polar coordinate interpolation mode and selects a polar coordinate interpolation plane (Fig. 3.1 (a)). Polar coordinate interpolation is performed on this plane.

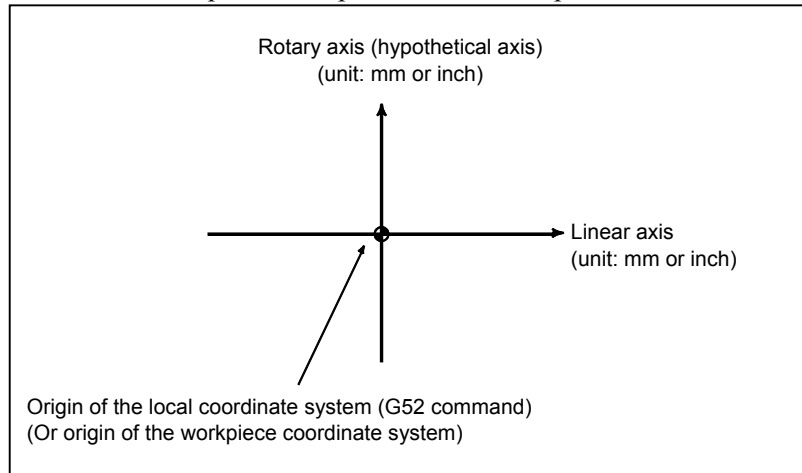

Fig. 3.1 (a) Polar coordinate interpolation plane

When the power is turned on or the system is reset, polar coordinate interpolation is canceled (G13.1). The linear and rotation axes for polar coordinate interpolation must be set in parameters Nos. 5460 and 5461 beforehand.

#### **CAUTION**

The plane used before G12.1 is specified (plane selected by G17, G18, or G19) is canceled. It is restored when G13.1 (canceling polar coordinate interpolation) is specified.

When the system is reset, polar coordinate interpolation is canceled and the plane specified by G17, G18, or G19 is used.

### - Distance moved and feedrate for polar coordinate interpolation

- The unit for coordinates on the hypothetical axis is the same as the unit for the linear axis (mm/inch). In the polar coordinate interpolation mode, program commands are specified with Cartesian coordinates on the polar coordinate interpolation plane. The axis address for the rotary axis is used as the axis address for the second axis (hypothetical axis) in the plane. Whether a diameter or radius is specified for the first axis in the plane is the same as for the rotary axis regardless of the specification for the first axis in the plane.

The hypothetical axis is at coordinate 0 immediately after G12.1 is specified. Polar interpolation is started assuming the rotation angle of 0 for the position of the tool when G12.1 is specified.

Example)

When a value on the X-axis (linear axis) is input in millimeters

G12.1;

G01 X10.0 F1000. ; ..... A 10.0-mm movement is made on the Cartesian coordinate system.

C20.0 ; ..... A 20.0-mm movement is made on the Cartesian coordinate system.

G13.1;

When a value on the X-axis (linear axis) is input in inches

G12.1;

G01 X10.0 F1000. ; .... A 10.0-inch movement is made on the Cartesian coordinate system.

C20.0 ; ..... A 20.0-inch movement is made on the Cartesian coordinate system.

G13.1;

- The unit for the feedrate is mm/min or inch/min.

Specify the feedrate as a speed (relative speed between the workpiece and tool) tangential to the polar coordinate interpolation plane (Cartesian coordinate system) using F.

- **G codes which can be specified in the polar coordinate interpolation mode**

G01.....Linear interpolation

G02, G03.....Circular interpolation

G04.....Dwell, Exact stop

G40, G41, G42.....Tool radius compensation (Polar coordinate interpolation is applied to the path after tool radius compensation.)

G65, G66, G67.....Custom macro command

G90, G91.....Absolute programming, incremental programming (For G code system B or C)

G94, G95.....Feed per minute, feed per revolution

- **Circular interpolation in the polar coordinate plane**

The addresses for specifying the radius of an arc for circular interpolation (G02 or G03) in the polar coordinate interpolation plane depend on the first axis in the plane (linear axis).

- I and J in the X<sub>p</sub>-Y<sub>p</sub> plane when the linear axis is the X-axis or an axis parallel to the X-axis.
- J and K in the Y<sub>p</sub>-Z<sub>p</sub> plane when the linear axis is the Y-axis or an axis parallel to the Y-axis.
- K and I in the Z<sub>p</sub>-X<sub>p</sub> plane when the linear axis is the Z-axis or an axis parallel to the Z-axis.

The radius of an arc can be specified also with an R command.

**NOTE**

The parallel axes U, V, and W can be used in the G code system B or C.

- **Movement along axes not in the polar coordinate interpolation plane in the polar coordinate interpolation mode**

The tool moves along such axes normally, independent of polar coordinate interpolation.

- **Current position display in the polar coordinate interpolation mode**

Actual coordinates are displayed. However, the remaining distance to move in a block is displayed based on the coordinates in the polar coordinate interpolation plane (Cartesian coordinates).

- **Coordinate system for the polar coordinate interpolation**

Basically, before G12.1 is specified, a local coordinate system (or workpiece coordinate system) where the center of the rotary axis is the origin of the coordinate system must be set.

In the G12.1 mode, the coordinate system must not be changed (G50, G52, G53, relative coordinate reset, G54 through G59, etc.).

- **Compensation in the direction of the hypothetical axis in polar coordinate interpolation**

If the first axis of the plane has an error from the center of the rotary axis in the hypothetical axis direction, in other words, if the rotary axis center is not on the X-axis, the hypothetical axis direction compensation function in the polar coordinate interpolation mode is used. With the function, the error is considered in polar coordinate interpolation. The amount of error is specified in parameter No. 5464.





**- Tool radius/tool nose radius compensation**

The polar coordinate interpolation mode (G12.1 or G13.1) cannot be started or terminated in the tool radius/tool nose radius compensation mode (G41 or G42). G12.1 or G13.1 must be specified in the tool radius/tool nose radius compensation canceled mode (G40).

For the tool radius/tool nose radius compensation canceled mode (G40) command, be sure to specify the polar coordinate axis to cancel the offset vector.

If the polar coordinate interpolation mode (G12.1 or G13.1) is switched without canceling the offset vector, the alarm PS0037, "CAN NOT CHANGE PLANE IN G41/G42" is occurred.

**- Tool offset command**

A tool offset must be specified before the G12.1 mode is set. No offset can be changed in the G12.1 mode.

**- Program restart**

For a block in the G12.1 mode, the program and the block cannot be restarted.

**- Cutting feedrate for the rotary axis**

Polar coordinate interpolation converts the tool movement for a figure programmed in a Cartesian coordinate system to the tool movement in the rotary axis (C-axis) and the linear axis (X-axis). When the tool comes close to the center of the workpiece, the C-axis velocity component increases. If the maximum cutting feedrate for the C-axis (parameter No. 1430) is exceeded, the automatic feedrate override function and automatic speed clamp function are enabled.

If the maximum cutting feedrate for the X-axis is exceeded, the automatic feedrate override function and automatic speed clamp function are enabled.

**⚠ WARNING**

- 1 Consider lines L1, L2, and L3.  $\Delta X$  is the distance the tool moves per time unit at the feedrate specified with address F in the Cartesian coordinate system. As the tool moves from L1 to L2 to L3, the angle at which the tool moves per time unit corresponding to  $\Delta X$  in the Cartesian coordinate system increases from  $\theta_1$  to  $\theta_2$  to  $\theta_3$ . In other words, the C-axis component of the feedrate becomes larger as the tool moves closer to the center of the workpiece. The C component of the feedrate may exceed the maximum cutting feedrate for the C-axis because the tool movement in the Cartesian coordinate system has been converted to the tool movement for the C-axis and the X-axis.

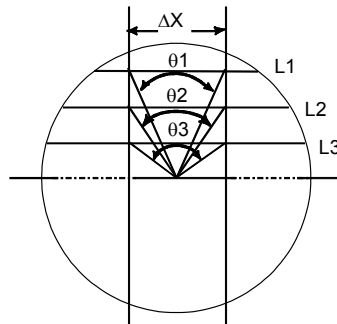

L: Distance (in mm) between the tool center and workpiece center when the tool center is the nearest to the workpiece center

R: Maximum cutting feedrate (deg/min) of the C axis

Then, a speed specifiable with address F in polar coordinate interpolation can be given by the formula below. If the maximum cutting feedrate for the C-axis is exceeded, the automatic speed control function for polar coordinate interpolation automatically controls the feedrate.

$$F < L \times R \times \frac{\pi}{180} \quad (\text{mm/min})$$

**- Automatic speed control for polar coordinate interpolation**

If the velocity component of the rotary axis exceeds the maximum cutting feedrate in the polar coordinate interpolation mode, the speed is automatically controlled.

**- Automatic override**

If the velocity component of the rotary axis exceeds the permissible velocity (maximum cutting feedrate multiplied by the permission factor specified in parameter No. 5463), the feedrate is automatically overridden as indicated below.

$$\text{Override} = (\text{Permissible velocity}) \div (\text{Velocity component of rotary axis}) \times 100(\%)$$

**- Automatic speed clamp**

If the velocity component of the rotary axis after automatic override still exceeds the maximum cutting feedrate, the speed of the rotary axis is automatically clamped. As a result, the velocity component of the rotary axis will not exceed the maximum cutting feedrate.

The automatic speed clamp function works only when the center of the tool is very close to the center of the rotary axis.

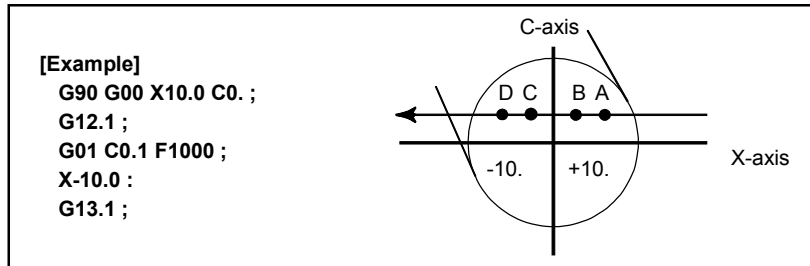

**Automatic speed control for polar coordinate interpolation**

Suppose that the maximum cutting feedrate of the rotary axis is 360 (3600 deg/min) and that the permission factor of automatic override for polar coordinate interpolation (parameter No. 5463) is 0 (90%). If the program indicated above is executed, the automatic override function starts working when the X coordinate becomes 2.273 (point A). The automatic speed clamp function starts working when the X coordinate becomes 0.524 (point B).

The minimum value of automatic override for this example is 3%. The automatic speed clamp function continues working until the X coordinate becomes -0.524 (point C). Then, the automatic override function works until the X coordinate becomes -2.273 (point D).

(The coordinates indicated above are the values in the Cartesian coordinate system.)

**NOTE**

- 1 While the automatic speed clamp function is working, the machine lock or interlock function may not be enabled immediately.
- 2 If a feed hold stop is made while the automatic speed clamp function is working, the automatic operation halt signal \*SP is output. However, the operation may not stop immediately.
- 3 The clamped speed may exceed the clamp value by a few percent.

**Example**

Sample program for polar coordinate interpolation in a Cartesian coordinate system consisting of the X-axis (a linear axis) and a hypothetical axis

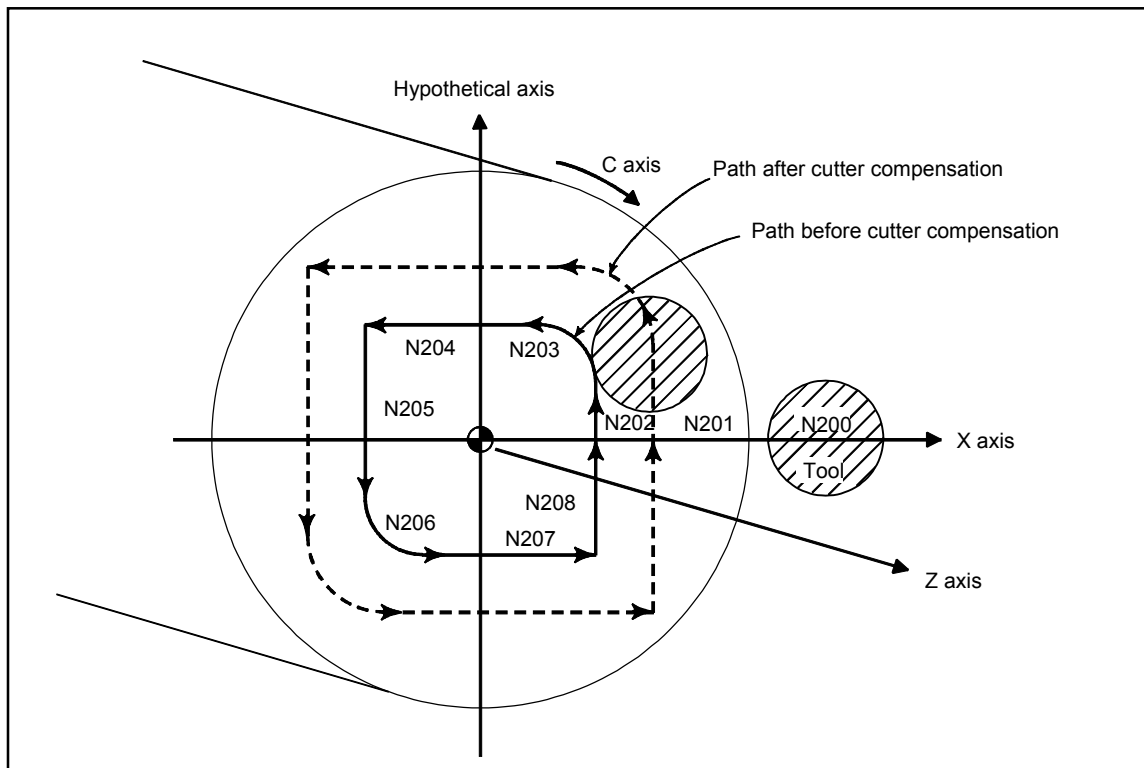

O0001;

N010 T0101

N0100 G90 G00 X60.0 C0 Z\_\_;

N0200 G12.1;

N0201 G42 G01 X20.0F\_\_;

N0202 C10.0;

N0203 G03 X10.0 C20.0 R10.0;

N0204 G01 X-20.0;

N0205 C-10.0;

N0206 G03 X-10.0 C-20.0 I10.0 J0;

N0207 G01 X20.0;

N0208 C0;

N0209 G40 X60.0;

N0210 G13.1;

N0300 Z\_\_;

N0400 X\_\_C\_\_;

N0900M30;

Positioning to start point

Start of polar coordinate interpolation

Geometry program

(program based on cartesian coordinates on  
X axis-hypothetical axis plane)

Cancellation of polar coordinate interpolation

## 3.2 CONSTANT LEAD THREADING (G32)

Tapered screws and scroll threads in addition to equal lead straight threads can be cut by using a G32 command.

The spindle speed is read from the position coder on the spindle in real time and converted to a cutting feedrate for feed-per minute mode, which is used to move the tool.

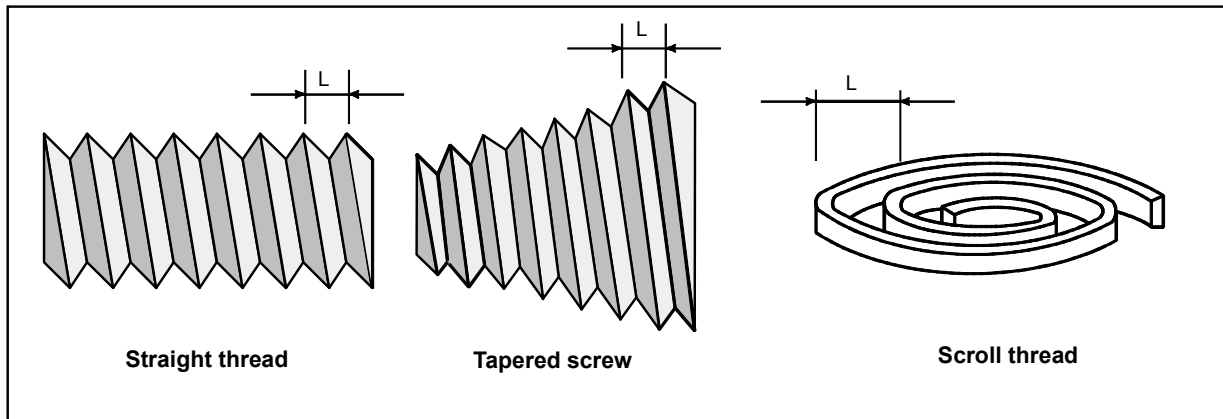

Fig. 3.2 (a) Thread types

### Format

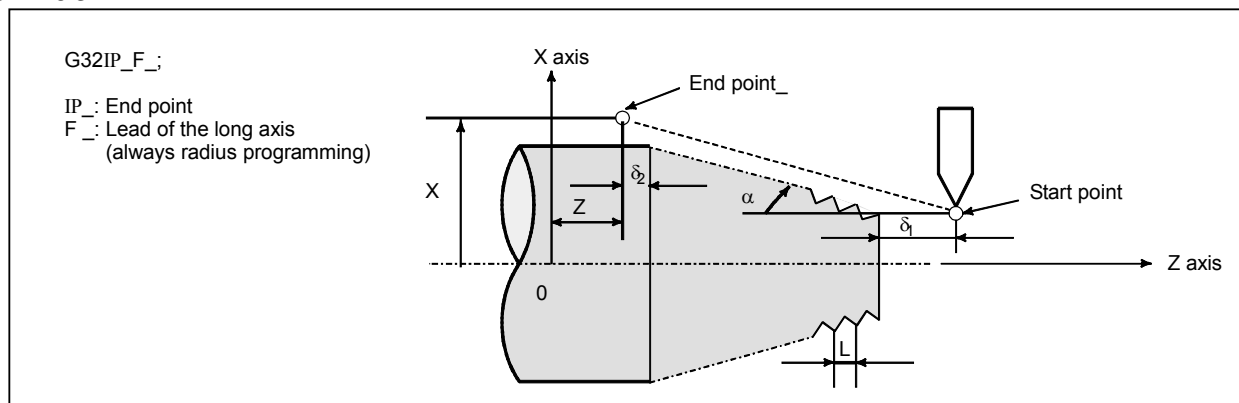
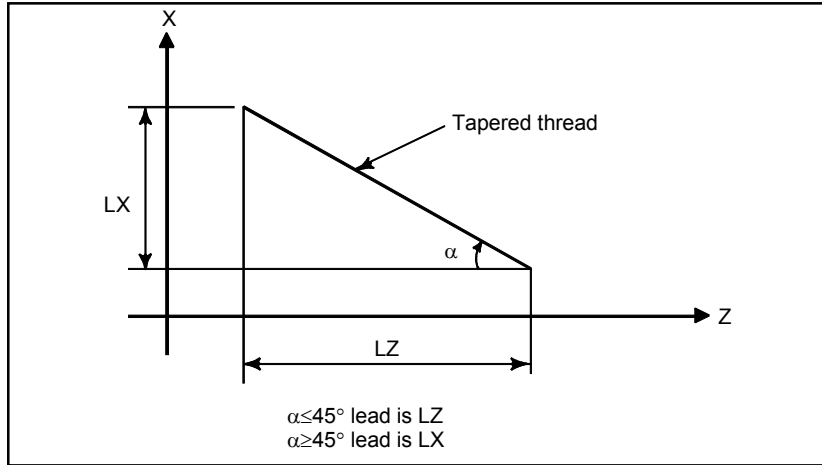

Fig. 3.2 (b) Example of threading

### Explanation

In general, threading is repeated along the same tool path in rough cutting through finish cutting for a screw. Since threading starts when the position coder mounted on the spindle outputs a one-spindle-rotation signal, threading is started at a fixed point and the tool path on the workpiece is unchanged for repeated threading. Note that the spindle speed must remain constant from rough cutting through finish cutting. If not, incorrect thread lead will occur.



**Fig. 3.2 (c) LZ and LX of a tapered thread**

In general, the lag of the servo system, etc. will produce somewhat incorrect leads at the starting and ending points of a thread cut. To compensate for this, a threading length somewhat longer than required should be specified.

Table 3.2 (a) lists the ranges for specifying the thread lead.

**Table 3.2 (a) Ranges of lead sizes that can be specified**

|              | Least command increment   |
|--------------|---------------------------|
| Metric input | 0.0001 to 500.0000 mm     |
| Inch input   | 0.000001 to 9.999999 inch |

**- Continuous threading**

The "continuous threading" is effective for G32.

**Example**

## 1. Straight threading

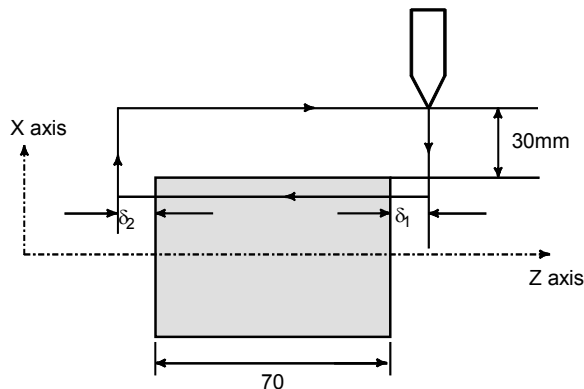

The following values are used in programming :  
 Thread lead :4mm  
 $\delta_1=3\text{mm}$   
 $\delta_2=1.5\text{mm}$   
 Depth of cut :1mm (cut twice)  
 (Metric input, diameter programming)

```
G00 U-62.0 ;
G32 W-74.5 F4.0 ;
G00 U62.0 ;
W74.5 ;
U-64.0 ;
(For the second cut, cut 1mm more)
G32 W-74.5 ;
G00 U64.0 ;
W74.5 ;
```

## 2. Tapered threading

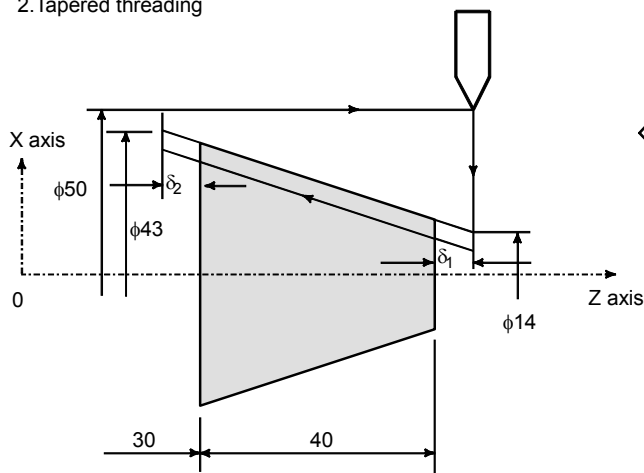

The following values are used in programming :  
 Thread lead : 3.5mm in the direction of the Z axis  
 $\delta_1=2\text{mm}$   
 $\delta_2=1\text{mm}$   
 Cutting depth in the X axis direction is 1mm (cut twice)  
 (Metric input, diameter programming)

```
G00 X 12.0 Z72.0 ;
G32 X 41.0 Z29.0 F3.5 ;
G00 X 50.0 ;
Z 72.0 ;
X 10.0 ;
(Cut 1mm more for the second cut)
G32 X 39.0 Z29.0 ;
G00 X 50.0 ;
Z 72.0 ;
```

**⚠ WARNING**

- 1 Feedrate override is effective (fixed at 100%) during threading.
- 2 It is very dangerous to stop feeding the thread cutter without stopping the spindle. This will suddenly increase the cutting depth. Thus, the feed hold function is ineffective while threading. If the feed hold button is pressed during threading, the tool will stop after a block not specifying threading is executed as if the SINGLE BLOCK button were pushed. However, the feed hold lamp (SPL lamp) lights when the FEED HOLD button on the machine control panel is pushed. Then, when the tool stops, the lamp is turned off (Single Block stop status).
- 3 When the FEED HOLD button is pressed again in the first block after threading mode that does not specify threading (or the button has been held down), the tool stops immediately at the block that does not specify threading.
- 4 When threading is executed in the single block status, the tool stops after execution of the first block not specifying threading.



**⚠ WARNING**

- 5 When the mode was changed from automatic operation to manual operation during threading, the tool stops at the first block not specifying threading as when the feed hold button is pushed as mentioned in Warning 3.  
However, when the mode is changed from one automatic operation mode to another, the tool stops after execution of the block not specifying threading as for the single block mode in Note 4.
- 6 When the previous block was a threading block, cutting will start immediately without waiting for detection of the one-spindle-rotation signal even if the present block is a threading block.  
(Example)
 

|                  |                        |
|------------------|------------------------|
| G00 Z0.0 X50.0 ; | One-rotation signal is |
| G32 Z10.0 F_ ;   | : Detected             |
| Z20.0 ;          | : Not detected         |
| G32 Z30.0 ;      | : Not detected         |
- 7 Because the constant surface speed control is effective during scroll thread or tapered screw cutting and the spindle speed changes, the correct thread lead may not be cut. Therefore, do not use the constant surface speed control during threading. Instead, use G97.
- 8 A movement block preceding the threading block must not specify chamfering or corner R.
- 9 A threading block must not specify chamfering or corner R.
- 10 The spindle speed override function is disabled during threading. The spindle speed is fixed at 100%.
- 11 Thread cycle retract function is ineffective to G32.
- 12 If tool offset (with the T code or G43.7) is specified in during of the threading mode, or in a block for threading, alarm PS0509, "TOOL OFFSET COMMAND IS NOT AVAILABLE", is issued.

### 3.3 VARIABLE LEAD THREADING (G34)

Specifying an increment or a decrement value for a lead per screw revolution enables variable lead threading to be performed.

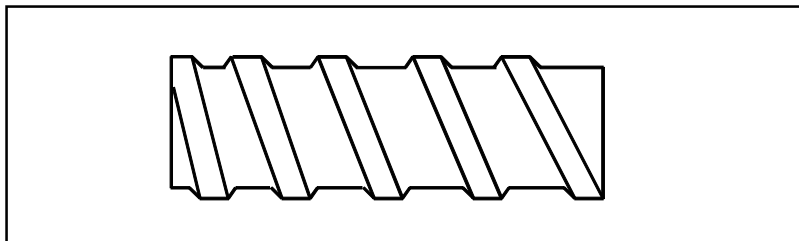

Fig. 3.3 (a) Variable lead screw

**NOTE**

When bit 1 (NVL) of parameter No.8137 is 0, this function can be used.

**Format**

**G34 IP\_ F\_ K\_ Q\_ ;**

- IP\_ : End point
- F\_ : Lead in longitudinal axis direction at the start point
- K\_ : Increment and decrement of lead per spindle revolution
- Q\_ : Shift amount of starting angle of thread cutting

**Explanation**

Address other than K are the same as in straight/taper thread cutting with G32.  
 The K value depends on the increment system of the reference axis, as indicated in Table 3.3 (a).  
 If the specified K value exceeds the range indicated in Table 3.3 (a), if the maximum lead is exceeded after a change due to the K value, or if the lead value is negative, an alarm PS0313, "ILLEGAL LEAD COMMAND", will be issued.

**Table 3.3 (a) Range of valid K values**

| Increment system of reference axis | Metric input (mm/rev) |              | Inch input (inch/rev) |               |
|------------------------------------|-----------------------|--------------|-----------------------|---------------|
| IS-A                               | ±0.001                | to ±500.000  | ±0.00001              | to ±50.00000  |
| IS-B                               | ±0.0001               | to ±500.0000 | ±0.000001             | to ±50.000000 |
| IS-C                               | ±0.00001              | to ±50.00000 | ±0.0000001            | to ±5.0000000 |

**Table 3.3 (b) Range of valid lead values**

| Metric input (mm)  | Inch input (inch)     |
|--------------------|-----------------------|
| 0.0001 to 500.0000 | 0.000001 to 50.000000 |

**- Continuous threading**

The "continuous threading" is effective for G34.



**CAUTION**

The "thread cutting cycle retract" is not effective for G34.

**Example**

Lead at the start point: 8.0 mm  
 Lead increment: 0.3 mm/rev  
 G34 Z-72.0 F8.0 K0.3 ;

**3.4 CIRCULAR THREADING (G35, G36)**

Using the G35 and G36 commands, a circular thread, having the specified lead in the direction of the major axis, can be machined.

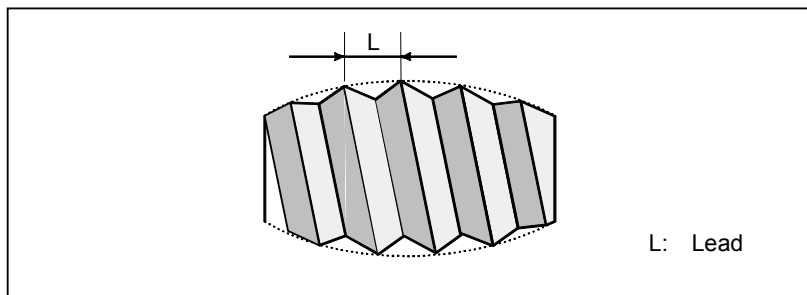

**Fig. 3.4 (a) Circular threading**

**NOTE**

This function is an optional function.

**Format**

A sample format for the G18 plane (Z-X plane) is indicated below. When using the format for the G17 plane (X-Y plane), change the addresses Z, X, K, and I to X, Y, I, and J respectively. When using the format for the G19 plane (Y-Z plane), change the addresses Z, X, K, and I to Y, Z, J, and K respectively.

$$\left\{ \begin{array}{l} \text{G35} \\ \text{G36} \end{array} \right\} \text{X(U)}_ \text{Z(W)}_ \left\{ \begin{array}{l} \text{I}_ \text{K}_ \\ \text{R}_ \end{array} \right\} \text{F}_ \text{Q}_ ;$$

G35 : Clockwise circular threading command

G36 : Counterclockwise circular threading command

X(U), Z(W) : Specify the arc end point (in the same way as for G02, G03).

I, K : Specify the arc center relative to the start point, using relative coordinates (in the same way as for G02, G03).

R : Specify the arc radius.

F : Specify the lead in the direction of the major axis.

Q : Specify the shift of the threading start angle  
(0° to 360°, with least input increment of 0.001)

(The value cannot be programmed with a decimal point.)

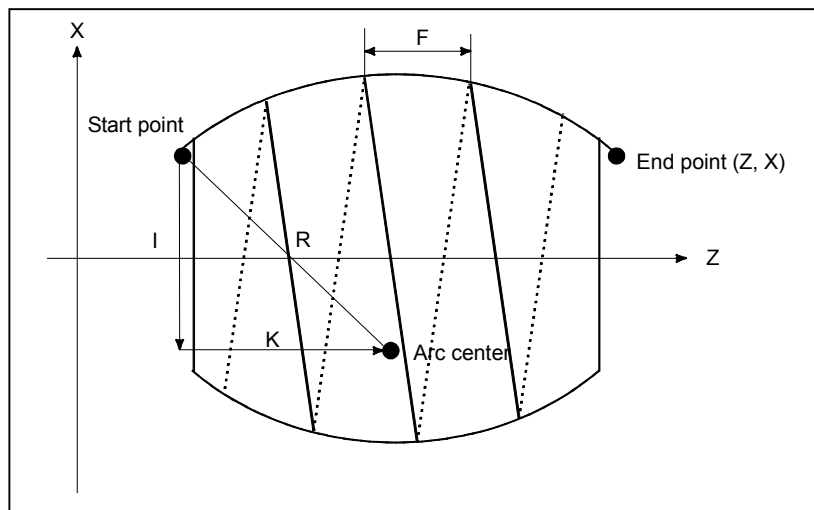
**Explanation**

- **Specifying the arc radius**

If R is specified with I and K, only R is effective.

- **Shift angle**

If an angle greater than 360° is programmed, it is set to 360°.

- **Continuous threading**

The "continuous threading" is effective for G35, G36.

- **Thread cutting cycle retract**

The "thread cutting cycle retract" is not effective for G35, G36.

**- Automatic tool compensation**

The G36 command is used to specify the following two functions: Automatic tool compensation X and counterclockwise circular threading. The function for which G36 is to be used depends on bit 3 (G36) of parameter No. 3405.

- When parameter G36 is set to 0, the G36 command is used for automatic tool compensation X.
  - When parameter G36 is set to 1, the G36 command is used for counterclockwise circular threading.
- G37.1 can be used to specify automatic tool compensation X and G37.2 can be used to specify automatic tool compensation Z.

(Specification method)

G37.1 X\_

G37.2 Z\_

- G code when bit 3 (G36) of parameter No. 3405 is set to 1

| G code | G code group | Function                            |
|--------|--------------|-------------------------------------|
| G35    | 01           | Clockwise circular threading        |
| G36    |              | Counterclockwise circular threading |
| G37    | 00           | Automatic tool compensation Z       |
| G37.1  |              | Automatic tool compensation X       |
| G37.2  |              | Automatic tool compensation Z       |

**Limitation**

**- Range of specifiable arc**

An arc must be specified such that it falls within a range in which the major axis of the arc is always the Z-axis or always the X-axis, as shown in Fig. 3.4 (b) and Fig. 3.4 (c). If the arc includes a point at which the major axis changes from the X-axis to Z-axis, or vice versa, as shown in Fig. 3.4 (d), an alarm PS5058, "G35/G36 FORMAT ERROR", is issued.

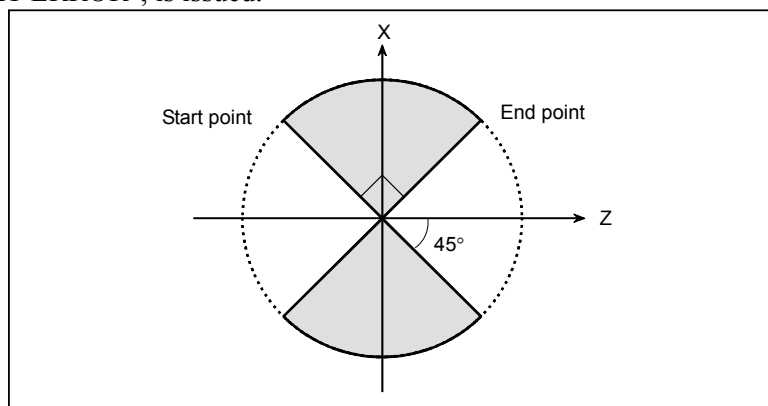

**Fig. 3.4 (b) Range in which the Z-axis is the major axis**

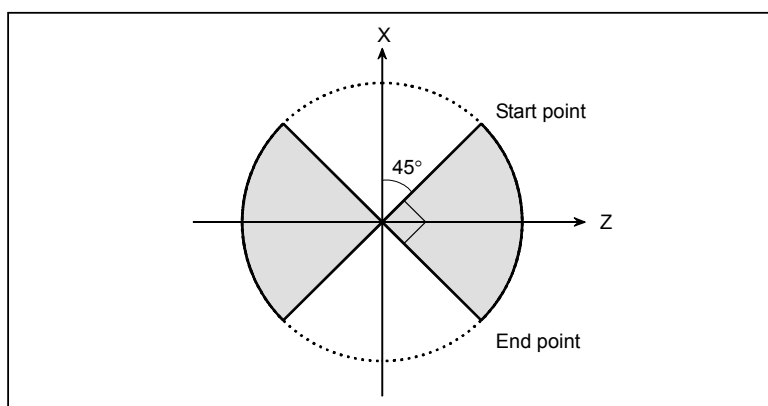

**Fig. 3.4 (c) Range in which the X-axis is the major axis**

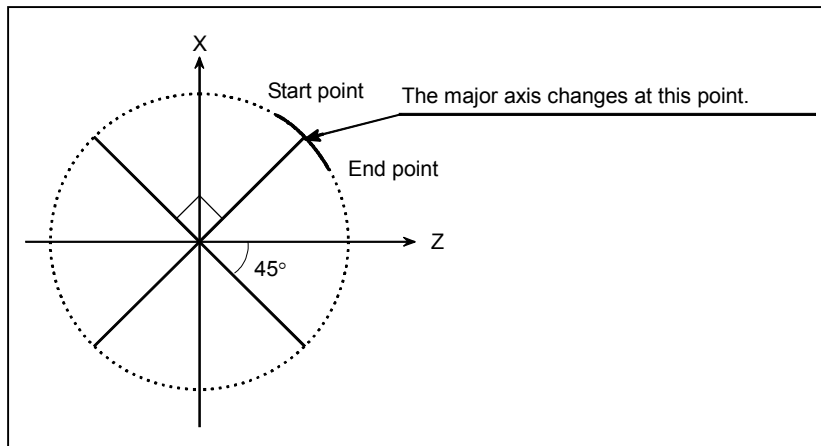

Fig. 3.4 (d) Example of arc specification which causes an alarm

**- End point not on an arc**

If the end point is not on an arc, a movement on an axis is made to a position of which coordinate matches the corresponding coordinate of the end point. Then, a movement is made on another axis to reach the end point.

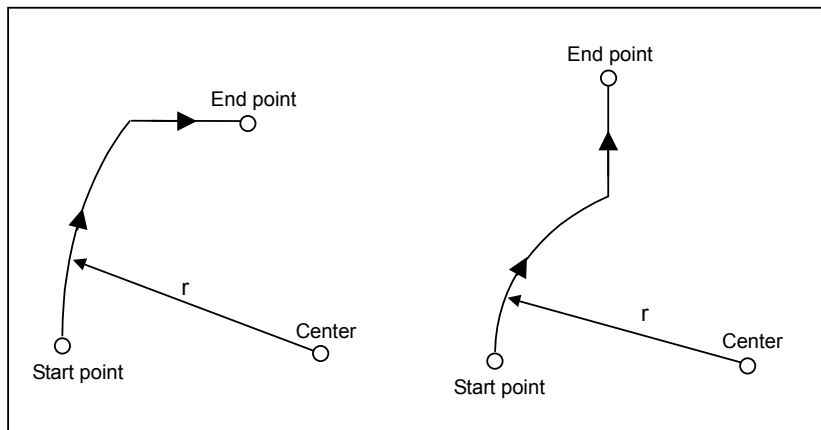

Fig. 3.4 (e) Movement when the end point is not on an arc

### 3.5 CONTINUOUS THREADING

Threading blocks can be programmed successively to eliminate a discontinuity due to a discontinuous movement in machining by adjacent blocks.

**Explanation**

Since the system is controlled in such a manner that the synchronism with the spindle does not deviate in the joint between blocks wherever possible, it is possible to performed special threading operation in which the lead and shape change midway.



Fig. 3.5 (a) Continuous threading (Example of G32 in G code system A)

Even when the same section is repeated for threading while changing the depth of cut, this system allows a correct machining without impairing the threads.

### - Available threading commands

- G32: Constant lead threading (G code system A)
- G33: Constant lead threading (G code system B/C)
- G34: Variable lead threading
- G35, G36: Circular threading

### - Start angle

The address Q (Angle for shifting the threading start angle) is only effective the first threading command block of continuous threading.

In the continuous threading, the addresses Q of the threading in the blocks after the first are ignored.

## 3.6 MULTIPLE THREADING

Using the Q address to specify an angle between the one-spindle-rotation signal and the start of threading shifts the threading start angle, making it possible to produce multiple-thread screws with ease.

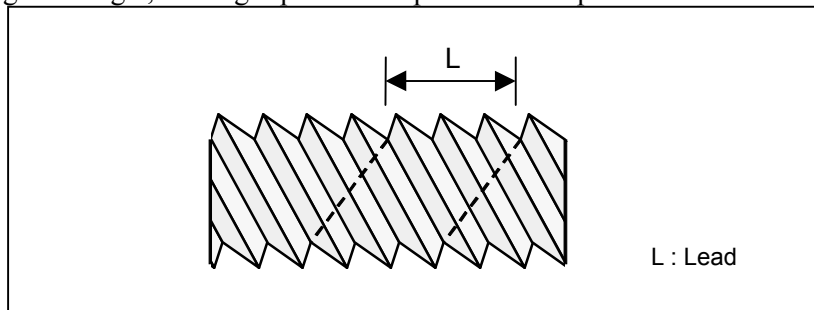

Fig. 3.6 (a) Multiple thread screws.

### Format

#### (Constant lead threading)

**G32 IP \_ F\_ Q\_ ;**

IP : End point

F\_ : Lead in longitudinal direction

**G32 IP \_ Q\_ ;**

Q\_ : Angle for shifting the threading start angle

(Increment: 0.001 degrees, Valid setting range: 0 to 360 degrees)

### Explanation

#### - Available threading commands

- G32: Constant lead threading
- G34: Variable lead threading
- G35, G36: Circular threading
- G76/G78: Multiple threading cycle (Only when the FS10/11 tape format is used.)
- G92: Threading cycle

### Limitation

#### - Start angle

The start angle is not a continuous state (modal) value. It must be specified each time it is used. If a value is not specified, 0 is assumed.

#### - Start angle increment

The start angle (Q) increment is 0.001 degrees. Note that no decimal point can be specified.

Example:

For a shift angle of 180 degrees, specify Q180000.

Q180.000 cannot be specified, because it contains a decimal point.

Note: Q1 is the command of 0.001 degree for the angle for shifting the threading start angle, regardless of the setting of the followings.

- Increment system IS-A/B/C(Parameter No.1013#1,#0)
- Pocket calculator type decimal point programming (Bit 0(DPI) of parameter No.3401)
- The least input increment is 10 times greater than the least command increment (Bit 7(IPR) of parameter No.1004)

#### - Specifiable start angle range

A start angle (Q) of between 0 and 360000 (in 0.001-degree units) can be specified. If a value greater than 360000 (360 degrees) is specified, it is rounded down to 360000 (360 degrees).

If a minus value is specified, it works as a plus value.

Example:

If Q-90000 (-90 degrees) is specified, it works as Q90000 (90 degrees).

#### - Multiple threading cycle (G76 (G code system A/B)) (G78 (G code system C))

The address Q of the G76/G78 multiple threading cycle command is used for the minimum cutting depth or the depth of cut in 1st cut. For this reason, the angle for shifting the threading start angle can not be commanded.

However, if the FS10/11 tape format is used, in G76/G78 multiple threading cycle, the address Q is possible to specify the angle for shifting the threading start angle.

### Example

#### Program for producing double-threaded screws (with start angles of 0 and 180 degrees)

```
X40.0 ;
W-38.0 F4.0 Q0 ;
X72.0 ;
W38.0 ;
X40.0 ;
W-38.0 F4.0Q180000 ;
X72.0 ;
W38.0 ;
```

# 4 FUNCTIONS TO SIMPLIFY PROGRAMMING

Chapter 4, "FUNCTIONS TO SIMPLIFY PROGRAMMING", consists of the following sections:

|   |     |
|---|-----|
| 4.1 CANNED CYCLE (G90, G92, G94).....                 | 34  |
| 4.2 MULTIPLE REPETITIVE CANNED CYCLE (G70-G76) .....  | 52  |
| 4.3 CANNED CYCLE FOR DRILLING .....                   | 91  |
| 4.4 RIGID TAPPING.....                                | 106 |
| 4.5 CANNED GRINDING CYCLE (FOR GRINDING MACHINE)..... | 119 |
| 4.6 CHAMFERING AND CORNER R.....                      | 129 |
| 4.7 MIRROR IMAGE FOR DOUBLE TURRET (G68, G69) .....   | 135 |
| 4.8 DIRECT DRAWING DIMENSION PROGRAMMING .....        | 136 |

## 4.1 CANNED CYCLE (G90, G92, G94)

There are three canned cycles : the outer diameter/internal diameter cutting canned cycle (G90), the threading canned cycle (G92), and the end face turning canned cycle (G94).

### NOTE

- 1 Explanatory figures in this section use the ZX plane as the selected plane, diameter programming for the X-axis, and radius programming for the Z-axis. When radius programming is used for the X-axis, change U/2 to U and X/2 to X.
- 2 A canned cycle can be performed on any plane (including parallel axes for plane definition). When G-code system A is used, however, U, V, and W cannot be set as a parallel axis.
- 3 The direction of the length means the direction of the first axis on the plane as follows:  
ZX plane: Z-axis direction  
YZ plane: Y-axis direction  
XY plane: X-axis direction
- 4 The direction of the end face means the direction of the second axis on the plane as follows:  
ZX plane: X-axis direction  
YZ plane: Z-axis direction  
XY plane: Y-axis direction



## 4.1.1 Outer Diameter/Internal Diameter Cutting Cycle (G90)

This cycle performs straight or taper cutting in the direction of the length.

### 4.1.1.1 Straight cutting cycle

#### Format

**G90X(U)\_Z(W)\_F\_;**

X\_,Z\_ : Coordinates of the cutting end point (point A' in the Fig. 4.1.1.1 (a)) in the direction of the length

U\_,W\_ : Travel distance to the cutting end point (point A' in the Fig. 4.1.1.1 (a)) in the direction of the length

F\_ : Cutting feedrate

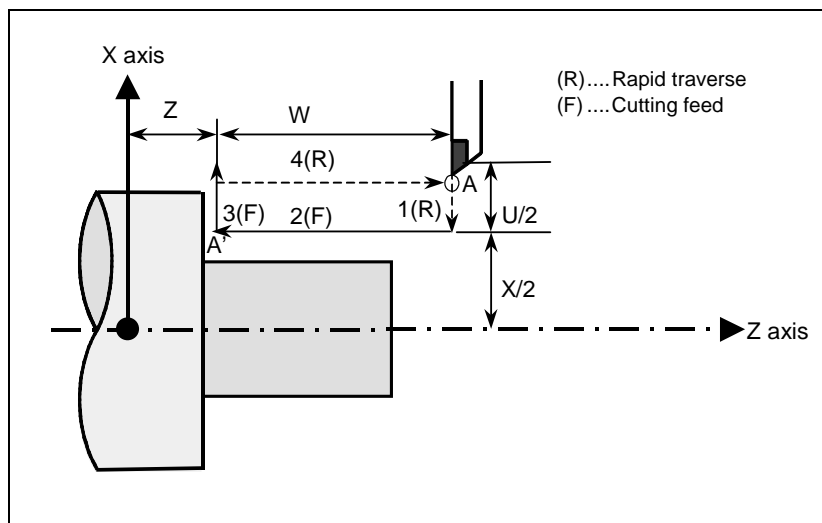

Fig. 4.1.1.1 (a) Straight cutting cycle

#### Explanation

##### - Operations

A straight cutting cycle performs four operations:

- (1) Operation 1 moves the tool from the start point (A) to the specified coordinate of the second axis on the plane (specified X-coordinate for the ZX plane) in rapid traverse.
- (2) Operation 2 moves the tool to the specified coordinate of the first axis on the plane (specified Z-coordinate for the ZX plane) in cutting feed. (The tool is moved to the cutting end point (A') in the direction of the length.)
- (3) Operation 3 moves the tool to the start coordinate of the second axis on the plane (start X-coordinate for the ZX plane) in cutting feed.
- (4) Operation 4 moves the tool to the start coordinate of the first axis on the plane (start Z-coordinate for the ZX plane) in rapid traverse. (The tool returns to the start point (A).)

#### NOTE

In single block mode, operations 1, 2, 3 and 4 are performed by pressing the cycle start button once.

##### - Canceling the mode

To cancel the canned cycle mode, specify a group 01 G code other than G90, G92, or G94.

### 4.1.1.2 Taper cutting cycle

#### Format

**G90 X(U)\_Z(W)\_R\_F\_;**

X\_,Z\_ : Coordinates of the cutting end point (point A' in the Fig. 4.1.1.2 (a)) in the direction of the length

U\_,W\_ : Travel distance to the cutting end point (point A' in the Fig. 4.1.1.2 (a)) in the direction of the length

R\_ : Taper amount (R in the Fig. 4.1.1.2 (a))

F\_ : Cutting feedrate

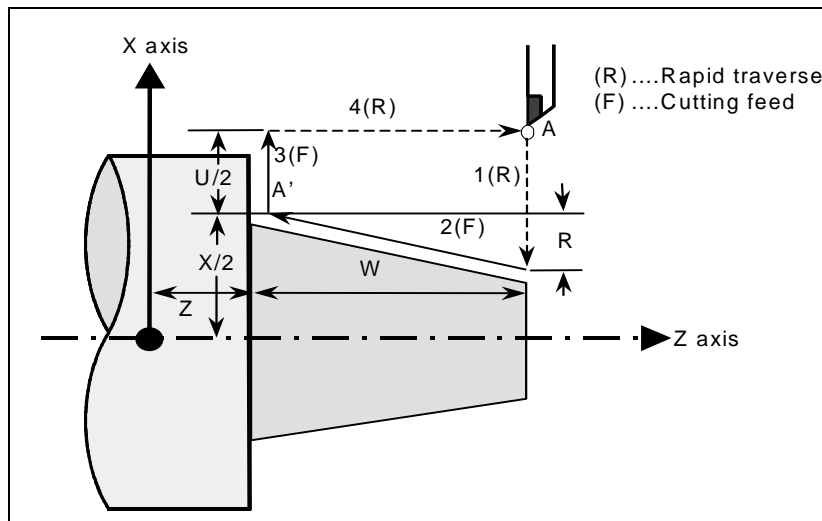

Fig. 4.1.1.2 (a) Taper cutting cycle

#### Explanation

The figure of a taper is determined by the coordinates of the cutting end point (A') in the direction of the length and the sign of the taper amount (address R). For the cycle in the Fig. 4.1.1.2 (a), a minus sign is added to the taper amount.

#### NOTE

The increment system of address R for specifying a taper depends on the increment system for the reference axis. Specify a radius value at R.

#### - Operations

A taper cutting cycle performs the same four operations as a straight cutting cycle.

However, operation 1 moves the tool from the start point (A) to the position obtained by adding the taper amount to the specified coordinate of the second axis on the plane (specified X-coordinate for the ZX plane) in rapid traverse.

Operations 2, 3, and 4 after operation 1 are the same as for a straight cutting cycle.

#### NOTE

In single block mode, operations 1, 2, 3, and 4 are performed by pressing the cycle start button once.

#### - Relationship between the sign of the taper amount and tool path

The tool path is determined according to the relationship between the sign of the taper amount (address R) and the cutting end point in the direction of the length in the absolute or incremental programming as Table 4.1.1.2 (a).

Table 4.1.1.2 (a)

| Outer diameter machining   | Internal diameter machining  |
|--|--|
| <p>1. <math>U &lt; 0, W &lt; 0, R &lt; 0</math></p>                                    | <p>2. <math>U &gt; 0, W &lt; 0, R &gt; 0</math></p>                                    |
| <p>3. <math>U &lt; 0, W &lt; 0, R &gt; 0</math><br/>at <math> R  \leq  U/2 </math></p> | <p>4. <math>U &gt; 0, W &lt; 0, R &lt; 0</math><br/>at <math> R  \leq  U/2 </math></p> |

### - Canceling the mode

To cancel the canned cycle mode, specify a group 01 G code other than G90, G92, or G94.

## 4.1.2 Threading Cycle (G92)

### 4.1.2.1 Straight threading cycle

#### Format

**G92 X(U)\_Z(W)\_F\_Q\_;**

X\_,Z\_ : Coordinates of the cutting end point (point A' in the Fig. 4.1.2.1 (a)) in the direction of the length

U\_,W\_ : Travel distance to the cutting end point (point A' in the Fig. 4.1.2.1 (a)) in the direction of the length

Q\_ : Angle for shifting the threading start angle  
(Increment: 0.001 degrees, Valid setting range: 0 to 360 degrees)

F\_ : Thread lead (L in the Fig. 4.1.2.1 (a))

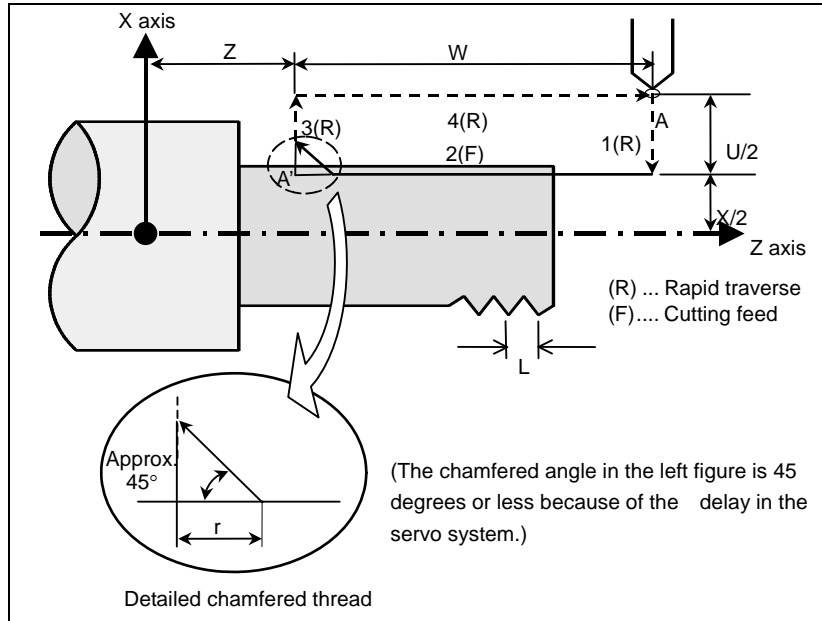

Fig. 4.1.2.1 (a) Straight threading

## Explanation

The ranges of thread leads and restrictions related to the spindle speed are the same as for threading with G32.

### - Operations

A straight threading cycle performs four operations:

- (1) Operation 1 moves the tool from the start point (A) to the specified coordinate of the second axis on the plane (specified X-coordinate for the ZX plane) in rapid traverse.
- (2) Operation 2 moves the tool to the specified coordinate of the first axis on the plane (specified Z-coordinate for the ZX plane) in cutting feed. At this time, thread chamfering is performed.
- (3) Operation 3 moves the tool to the start coordinate of the second axis on the plane (start X-coordinate for the ZX plane) in rapid traverse. (Retraction after chamfering)
- (4) Operation 4 moves the tool to the start coordinate of the first axis on the plane (start Z-coordinate for the ZX plane) in rapid traverse. (The tool returns to the start point (A).)

### ⚠ CAUTION

Notes on this threading are the same as in threading in G32. However, a stop by feed hold is as follows; Stop after completion of path 3 of threading cycle.

### NOTE

In the single block mode, operations 1, 2, 3, and 4 are performed by pressing cycle start button once.

### - Canceling the mode

To cancel the canned cycle mode, specify a group 01 G code other than G90, G92, or G94.

### - Acceleration/deceleration after interpolation for threading

Acceleration/deceleration after interpolation for threading is acceleration/deceleration of exponential interpolation type. By setting bit 5 (THLx) of parameter No. 1610, the same acceleration/deceleration as for cutting feed can be selected. (The settings of bits 1 (CTBx) and 0 (CTLx) of parameter No. 1610 are followed.) However, as a time constant and FL feedrate, the settings of parameter No. 1626 and No. 1627 for the threading cycle are used.

#### - Time constant and FL feedrate for threading

The time constant for acceleration/deceleration after interpolation for threading specified in parameter No. 1626 and the FL feedrate specified in parameter No. 1627 are used.

The FL feedrate is valid only for exponential acceleration/deceleration after interpolation.

#### - Thread chamfering

Thread chamfering can be performed. A signal from the machine tool, initiates thread chamfering. The chamfering distance  $r$  is specified in a range from  $0.1L$  to  $12.7L$  in  $0.1L$  increments by parameter No. 5130. (In the above expression,  $L$  is the thread lead.)

A thread chamfering angle between 1 to 89 degrees can be specified in parameter No. 5131. When a value of 0 is specified in the parameter, an angle of 45 degrees is assumed.

For thread chamfering, the same type of acceleration/deceleration after interpolation, time constant for acceleration/deceleration after interpolation, and FL feedrate as for threading are used.

#### NOTE

Common parameters for specifying the amount and angle of thread chamfering are used for this cycle and threading cycle with G76.

#### - Retraction after chamfering

The Table 4.1.2.1 (a) lists the feedrate, type of acceleration/deceleration after interpolation, and time constant of retraction after chamfering.

Table 4.1.2.1 (a)

| Bit 0 (CFR) of parameter No. 1611 | Parameter No. 1466 | Description  |
|-----------------------------------|--------------------|--|
| 0                                 | Other than 0       | Uses the type of acceleration/deceleration after interpolation for threading, time constant for threading (parameter No. 1626), FL feedrate (parameter No. 1627), and retraction feedrate specified in parameter No. 1466.   |
| 0                                 | 0                  | Uses the type of acceleration/deceleration after interpolation for threading, time constant for threading (parameter No. 1626), FL feedrate (parameter No. 1627), and rapid traverse rate specified in parameter No. 1420.   |
| 1                                 |                    | Before retraction a check is made to see that the specified feedrate has become 0 (delay in acceleration/deceleration is 0), and the type of acceleration/deceleration after interpolation for rapid traverse is used together with the rapid traverse time constant and the rapid traverse rate (parameter No. 1420). |

By setting bit 4 (ROC) of parameter No. 1403 to 1, rapid traverse override can be disabled for the feedrate of retraction after chamfering.

#### NOTE

During retraction, the machine does not stop with an override of 0% for the cutting feedrate regardless of the setting of bit 4 (RF0) of parameter No. 1401.

#### - Shifting the start angle

Address Q can be used to shift the threading start angle.

The start angle (Q) increment is 0.001 degrees and the valid setting range is between 0 and 360 degrees. No decimal point can be specified.

- **Feed hold in a threading cycle (Threading cycle retract)**

When feed hold is applied during threading (operation 2), the tool immediately retracts with chamfering and returns to the start point on the second axis (X-axis), then the first axis (Z-axis) on the plane.

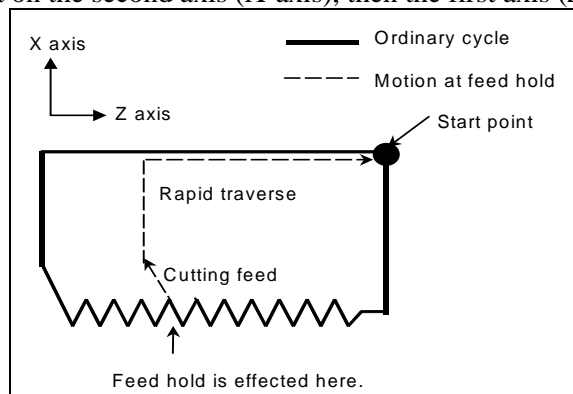

The chamfered angle is the same as that at the end point.

**CAUTION**

Another feed hold cannot be made during retreat.

- **Inch threading**

Inch threading specified with address E is not allowed.

**4.1.2.2 Taper threading cycle**

**Format**

**G92 X(U)\_Z(W)\_R\_F\_Q\_;**

X\_,Z\_ : Coordinates of the cutting end point (point A' in the Fig. 4.1.2.2 (a)) in the direction of the length

U\_,W\_ : Travel distance to the cutting end point (point A' in the Fig. 4.1.2.2 (a)) in the direction of the length

Q\_ : Angle for shifting the threading start angle  
(Increment: 0.001 degrees, Valid setting range: 0 to 360 degrees)

R\_ : Taper amount (R in the Fig. 4.1.2.2 (a))

F\_ : Thread lead (L in the Fig. 4.1.2.2 (a))

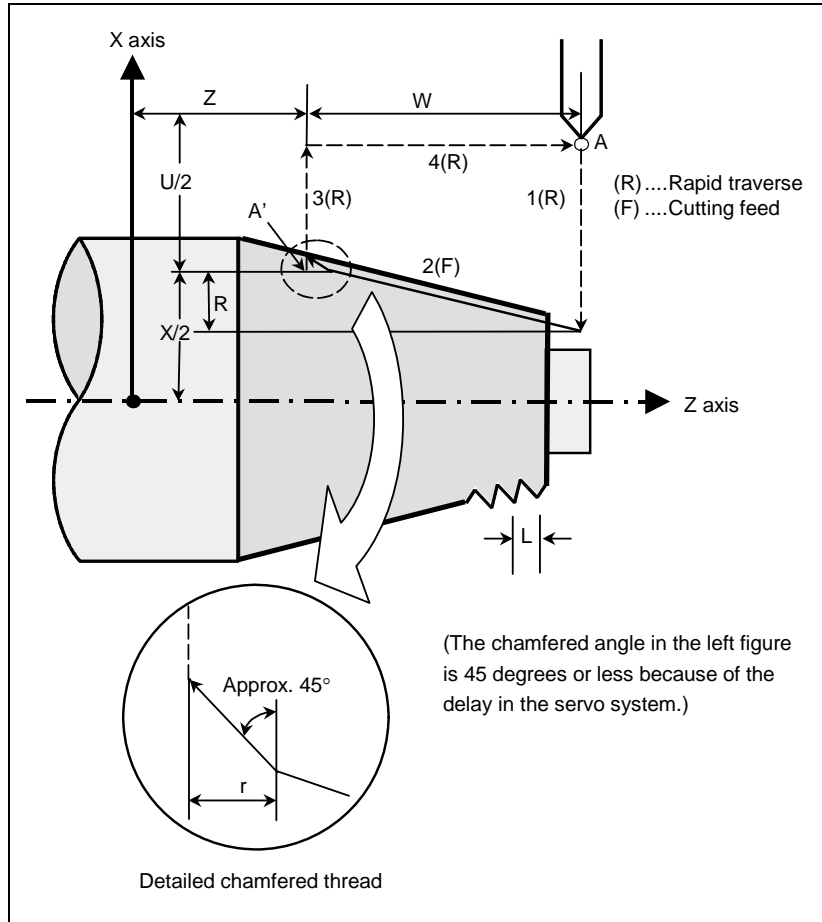

Fig. 4.1.2.2 (a) Taper threading cycle

## Explanation

The ranges of thread leads and restrictions related to the spindle speed are the same as for threading with G32.

The figure of a taper is determined by the coordinates of the cutting end point (A') in the direction of the length and the sign of the taper amount (address R). For the cycle in the Fig. 4.1.2.2 (a), a minus sign is added to the taper amount.

### NOTE

The increment system of address R for specifying a taper depends on the increment system for the reference axis. Specify a radius value at R.

### - Operations

A taper threading cycle performs the same four operations as a straight threading cycle.

However, operation 1 moves the tool from the start point (A) to the position obtained by adding the taper amount to the specified coordinate of the second axis on the plane (specified X-coordinate for the ZX plane) in rapid traverse.

Operations 2, 3, and 4 after operation 1 are the same as for a straight threading cycle.

### ⚠ CAUTION

Notes on this threading are the same as in threading in G32. However, a stop by feed hold is as follows; Stop after completion of path 3 of threading cycle.

**NOTE**

In the single block mode, operations 1, 2, 3, and 4 are performed by pressing cycle start button once.

**- Relationship between the sign of the taper amount and tool path**

The tool path is determined according to the relationship between the sign of the taper amount (address R) and the cutting end point in the direction of the length in the absolute or incremental programming as Table 4.1.2.2 (a).

Table 4.1.2.2 (a)

| Outer diameter machining   | Internal diameter machining  |
|--|--|
| <p>1. <math>U &lt; 0, W &lt; 0, R &lt; 0</math></p>                                    | <p>2. <math>U &gt; 0, W &lt; 0, R &gt; 0</math></p>                                    |
| <p>3. <math>U &lt; 0, W &lt; 0, R &gt; 0</math><br/>at <math> R  \leq  U/2 </math></p> | <p>4. <math>U &gt; 0, W &lt; 0, R &lt; 0</math><br/>at <math> R  \leq  U/2 </math></p> |

**- Canceling the mode**

To cancel the canned cycle mode, specify a group 01 G code other than G90, G92, or G94.

- Acceleration/deceleration after interpolation for threading
- Time constant and FL feedrate for threading
- Thread chamfering
- Retraction after chamfering
- Shifting the start angle
- Threading cycle retract
- Inch threading

See the pages on which a straight threading cycle is explained.



## 4.1.3 End Face Turning Cycle (G94)

### 4.1.3.1 Face cutting cycle

#### Format

**G94 X(U)\_Z(W)\_F\_;**

X\_,Z\_ : Coordinates of the cutting end point (point A' in the Fig. 4.1.3.1 (a)) in the direction of the end face

U\_,W\_ : Travel distance to the cutting end point (point A' in the Fig. 4.1.3.1 (a)) in the direction of the end face

F\_ : Cutting feedrate

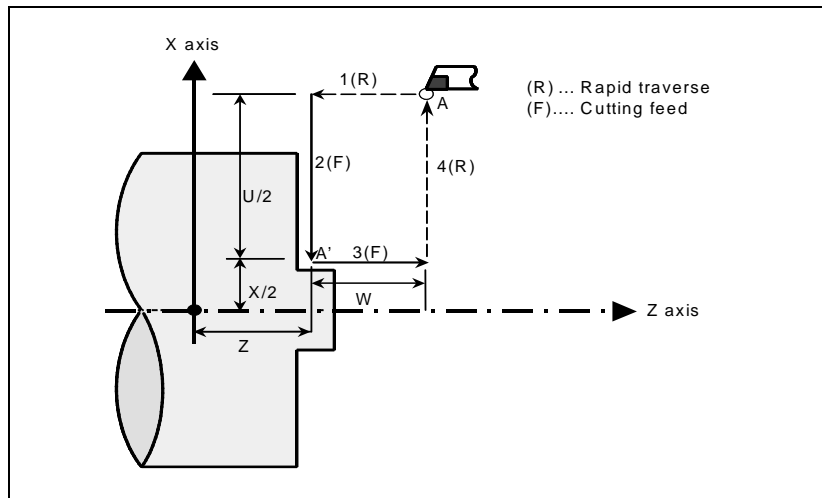

Fig. 4.1.3.1 (a) Face cutting cycle

#### Explanation

##### - Operations

A face cutting cycle performs four operations:

- (1) Operation 1 moves the tool from the start point (A) to the specified coordinate of the first axis on the plane (specified Z-coordinate for the ZX plane) in rapid traverse.
- (2) Operation 2 moves the tool to the specified coordinate of the second axis on the plane (specified X-coordinate for the ZX plane) in cutting feed. (The tool is moved to the cutting end point (A') in the direction of the end face.)
- (3) Operation 3 moves the tool to the start coordinate of the first axis on the plane (start Z-coordinate for the ZX plane) in cutting feed.
- (4) Operation 4 moves the tool to the start coordinate of the second axis on the plane (start X-coordinate for the ZX plane) in rapid traverse. (The tool returns to the start point (A).)

#### NOTE

In single block mode, operations 1, 2, 3, and 4 are performed by pressing the cycle start button once.

##### - Canceling the mode

To cancel the canned cycle mode, specify a group 01 G code other than G90, G92, or G94.

### 4.1.3.2 Taper cutting cycle

#### Format

**G94 X(U)\_Z(W)\_R\_F\_;**

X\_,Z\_ : Coordinates of the cutting end point (point A' in the Fig. 4.1.3.2 (a)) in the direction of the end face

U\_,W\_ : Travel distance to the cutting end point (point A' in the Fig. 4.1.3.2 (a)) in the direction of the end face

R\_ : Taper amount (R in the Fig. 4.1.3.2 (a))

F\_ : Cutting feedrate

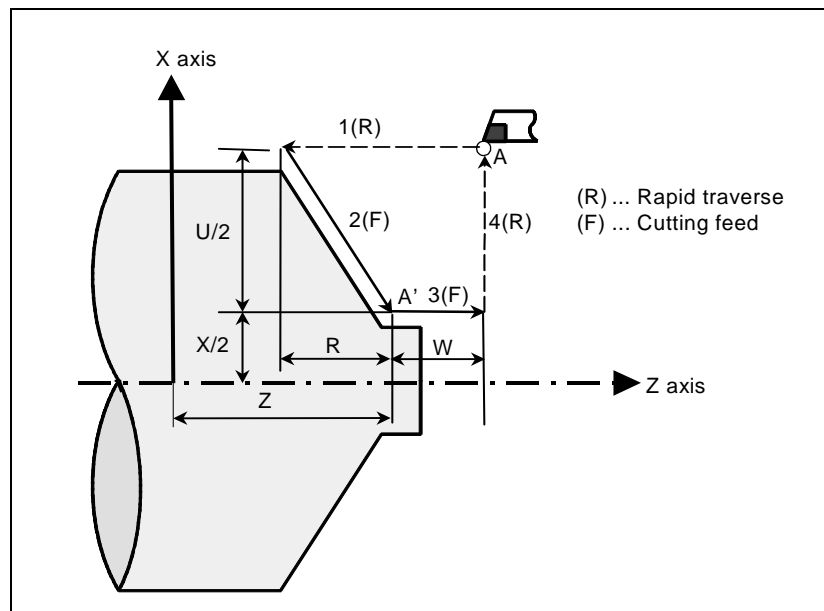

Fig. 4.1.3.2 (a) Taper cutting cycle

#### Explanation

The figure of a taper is determined by the coordinates of the cutting end point (A') in the direction of the end face and the sign of the taper amount (address R). For the cycle in the Fig. 4.1.3.2 (a), a minus sign is added to the taper amount.

#### NOTE

The increment system of address R for specifying a taper depends on the increment system for the reference axis. Specify a radius value at R.

#### - Operations

A taper cutting cycle performs the same four operations as a face cutting cycle.

However, operation 1 moves the tool from the start point (A) to the position obtained by adding the taper amount to the specified coordinate of the first axis on the plane (specified Z-coordinate for the ZX plane) in rapid traverse.

Operations 2, 3, and 4 after operation 1 are the same as for a face cutting cycle.

#### NOTE

In single block mode, operations 1, 2, 3, and 4 are performed by pressing the cycle start button once.

**- Relationship between the sign of the taper amount and tool path**

The tool path is determined according to the relationship between the sign of the taper amount (address R) and the cutting end point in the direction of the end face in the absolute or incremental programming as Table 4.1.3.2 (a).

Table 4.1.3.2 (a)

| Outer diameter machining  | Internal diameter machining   |
|---|---|
| <p><b>1. <math>U &lt; 0, W &lt; 0, R &lt; 0</math></b></p>                                  | <p><b>2. <math>U &gt; 0, W &lt; 0, R &lt; 0</math></b></p>                                  |
| <p><b>3. <math>U &lt; 0, W &lt; 0, R &gt; 0</math><br/>at <math> R  \leq  W </math></b></p> | <p><b>4. <math>U &gt; 0, W &lt; 0, R &gt; 0</math><br/>at <math> R  \leq  W </math></b></p> |

**- Canceling the mode**

To cancel the canned cycle mode, specify a group 01 G code other than G90, G92, or G94.

**4.1.4 How to Use Canned Cycles (G90, G92, G94)**

An appropriate canned cycle is selected according to the shape of the material and the shape of the product.

**- Straight cutting cycle (G90)**

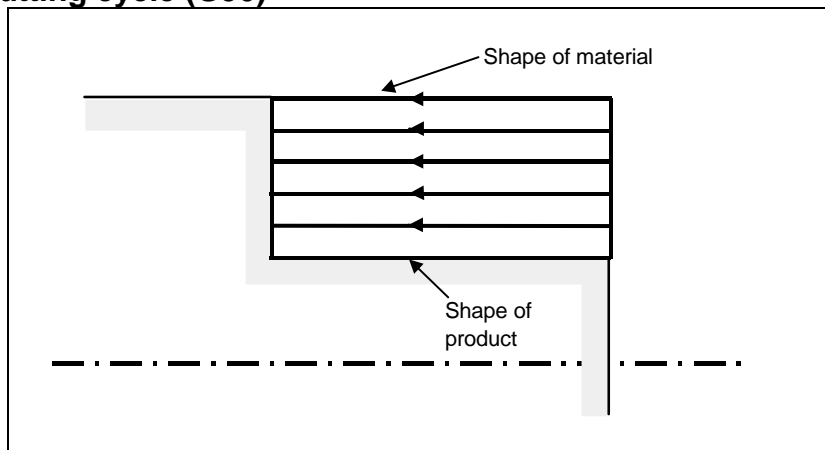

- **Taper cutting cycle (G90)**

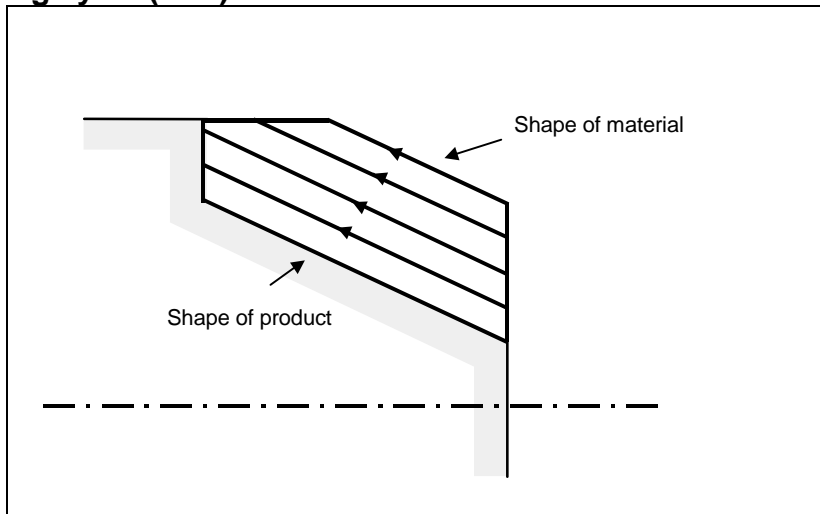

- **Face cutting cycle (G94)**

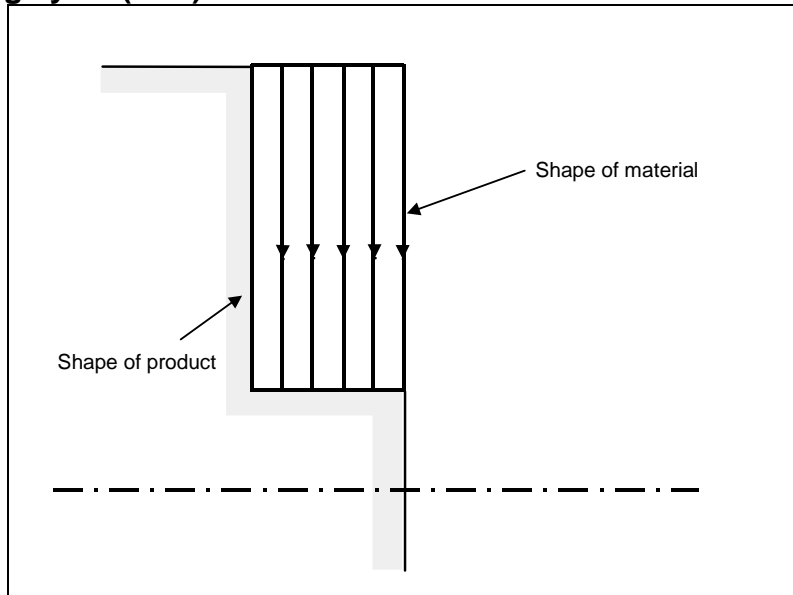

- **Face taper cutting cycle (G94)**

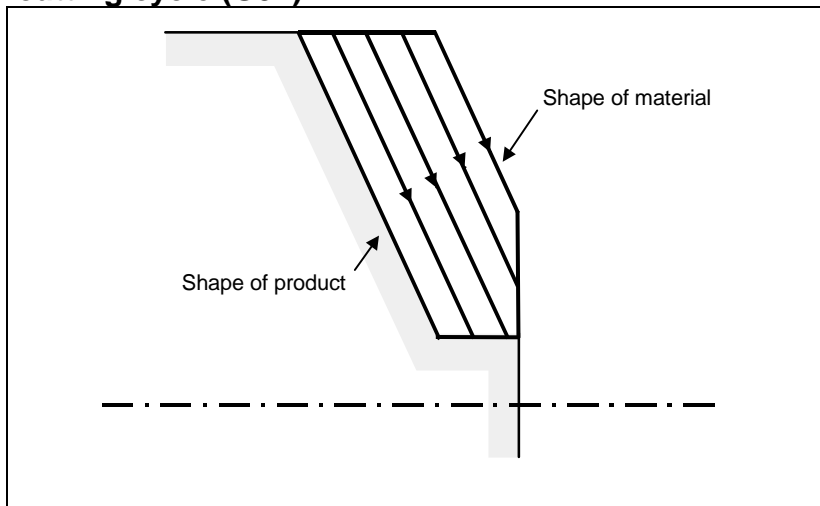

### 4.1.5 Canned Cycle and Tool Nose Radius Compensation

When tool nose radius compensation is applied, the tool nose center path and offset direction are as shown below. At the start point of a cycle, the offset vector is canceled. Offset start-up is performed for the movement from the start point of the cycle. The offset vector is temporarily canceled again at the return to the cycle start point and offset is applied again according to the next move command. The offset direction is determined depending of the cutting pattern regardless of the G41 or G42 mode.

#### Outer diameter/internal diameter cutting cycle (G90)

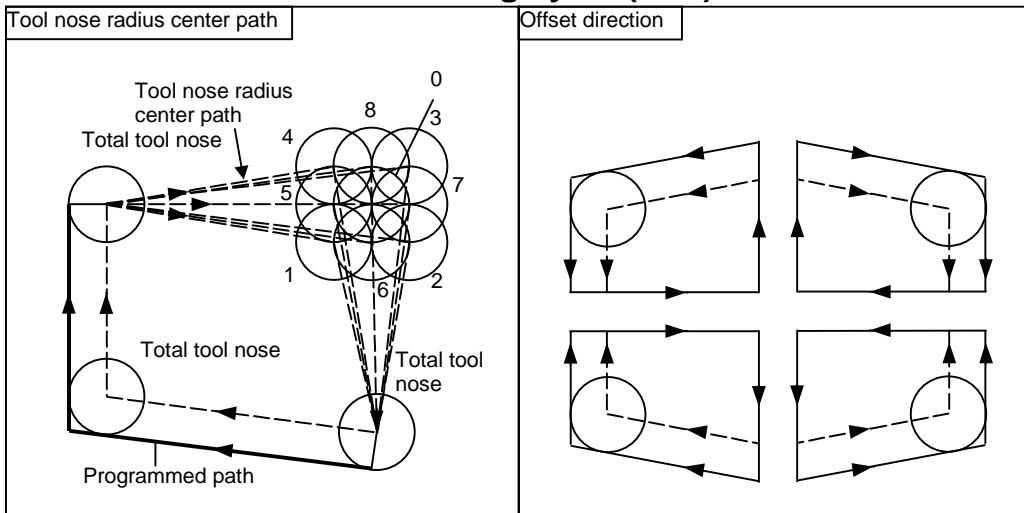

#### End face cutting cycle (G94)

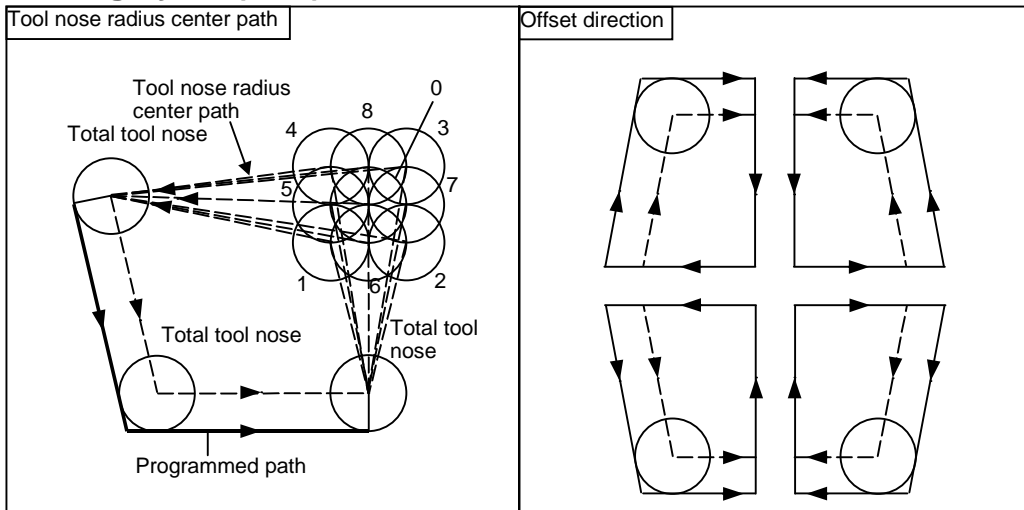

#### Threading cycle (G92)

Tool nose radius compensation cannot be applied.

### Differences between this CNC and the FANUC Series 0i-C

**NOTE**

This CNC is the same as the FANUC Series 0i-C in the offset direction, but differs from the series in the tool nose radius center path.

- For this CNC

Cycle operations of a canned cycle are replaced with G00 or G01. In the first block to move the tool from the start point, start-up is performed. In the last block to return the tool to the start point, offset is canceled.

- For the FANUC Series 0i-C

This series differs from this CNC in operations in the block to move the tool from the start point and the last block to return it to the start point. For details, refer to "FANUC Series 0i-C Operator's Manual."

### How compensation is applied for the FANUC Series 0i-C

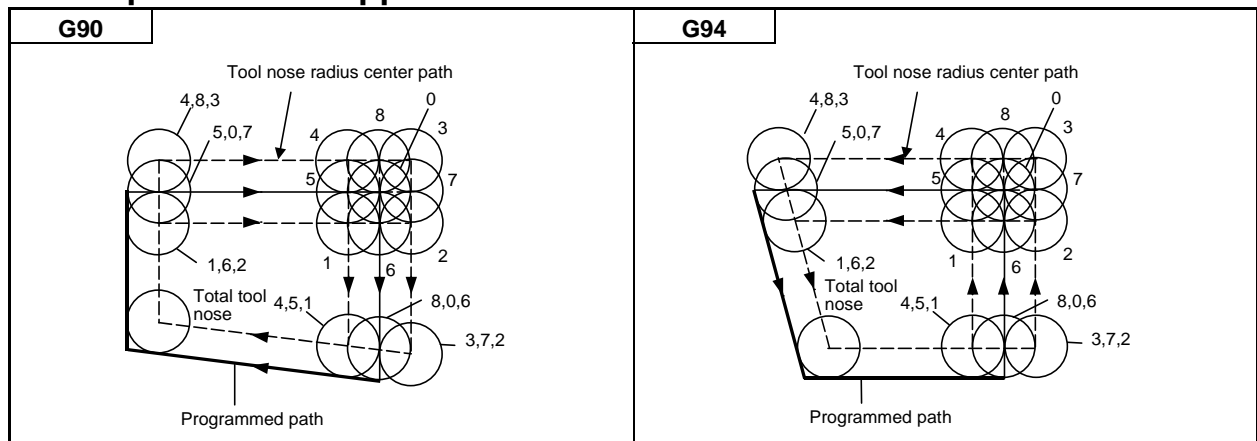

### 4.1.6 Restrictions on Canned Cycles

**Limitation**

- **Modal**

Since data items X (U), Z (W), and R in a canned cycle are modal values common to G90, G92, and G94. For this reason, if a new X (U), Z (W), or R value is not specified, the previously specified value is effective.

Thus, when the travel distance along the Z-axis does not vary as shown in the program example below, a canned cycle can be repeated only by specifying the travel distance along the X-axis.

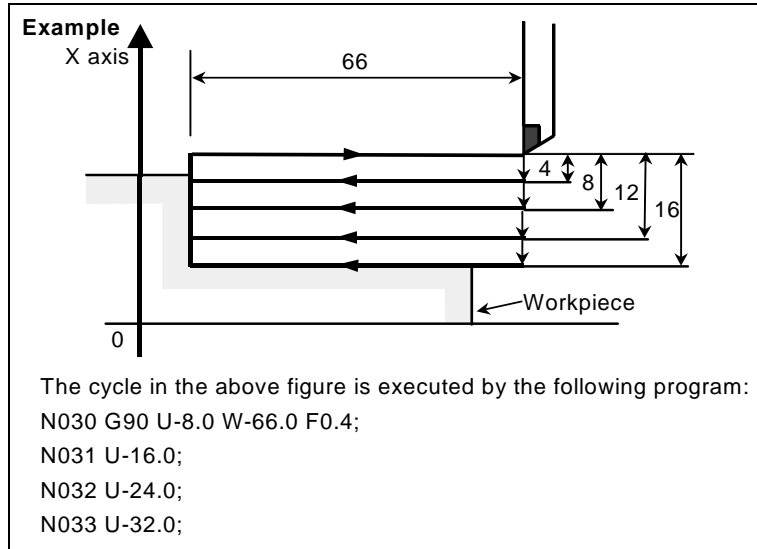

The modal values common to canned cycles are cleared when a one-shot G code other than G04 is specified.

Since the canned cycle mode is not canceled by specifying a one-shot G code, a canned cycle can be performed again by specifying modal values. If no modal values are specified, no cycle operations are performed.

When G04 is specified, G04 is executed and no canned cycle is performed.

#### - Block in which no move command is specified

In a block in which no move command is specified in the canned cycle mode, a canned cycle is also performed. For example, a block containing only EOB or a block in which none of the M, S, and T codes, and move commands are specified is of this type of block. When an M, S, or T code is specified in the canned cycle mode, the corresponding M, S, or T function is executed together with the canned cycle. If this is inconvenient, specify a group 01 G code (G00 or G01) other than G90, G92, or G94 to cancel the canned cycle mode, and specify an M, S, or T code, as in the program example below. After the corresponding M, S, or T function has been executed, specify the canned cycle again.

#### Example

```

N003 T0101;
:
:
N010 G90 X20.0 Z10.0 F0.2;
N011 G00 T0202; ← Cancels the canned cycle mode.
N012 G90 X20.5 Z10.0;

```

#### - Plane selection command

Specify a plane selection command (G17, G18, or G19) before setting a canned cycle or specify it in the block in which the first canned cycle is specified.

If a plane selection command is specified in the canned cycle mode, the command is executed, but the modal values common to canned cycles are cleared.

If an axis which is not on the selected plane is specified, alarm PS0330, "ILLEGAL AXIS COMMAND IS IN THE TURNING CANNED CYCLE" is issued.

#### - Parallel axis

When G code system A is used, U, V, and W cannot be specified as a parallel axis.

**- Reset**

If a reset operation is performed during execution of a canned cycle when any of the following states for holding a modal G code of group 01 is set, the modal G code of group 01 is replaced with the G01 mode:

- Reset state (bit 6 (CLR) of parameter No. 3402 = 0)
- Cleared state (bit 6 (CLR) of parameter No. 3402 = 1) and state where the modal G code of group 01 is held at reset time (bit 1 (C01) of parameter No. 3406 = 1)

Example of operation)

If a reset is made during execution of a canned cycle (X0 block) and the X20.Z1. command is executed, linear interpolation (G01) is performed instead of the canned cycle.

**- Manual intervention**

After manual intervention is performed with the manual absolute on command before the execution of a canned cycle or after the stop of the execution, when a cycle operation starts, the manual intervention amount is canceled even with an incremental cycle start command.

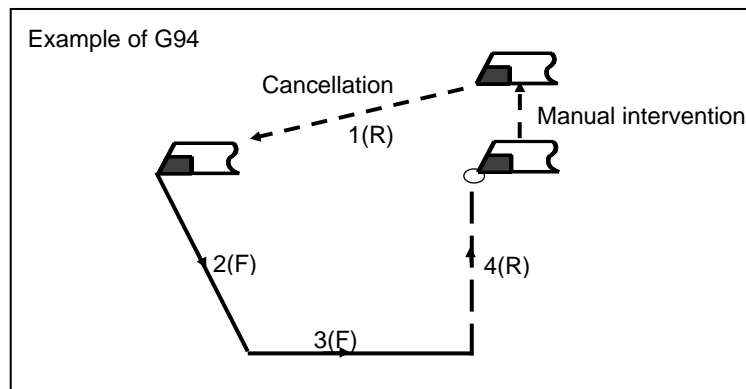



## 4.2 MULTIPLE REPETITIVE CANNED CYCLE (G70-G76)

The multiple repetitive canned cycle is canned cycles to make CNC programming easy. For instance, the data of the finish work shape describes the tool path for rough machining. And also, a canned cycles for the threading is available.

### NOTE

- 1 When bit 3 (NMR) of parameter No.8137 is 0, "Multiple repetitive canned cycle" can be used.  
Though, a canned grinding cycle and multiple repetitive canned cycle cannot be used simultaneously. When the canned grinding cycle (the option, "Grinding function A" or "Grinding function B") is enabled, the multiple repetitive canned cycle is disabled.
- 2 Explanatory figures in this section use the ZX plane as the selected plane, diameter programming for the X-axis, and radius programming for the Z-axis.  
When radius programming is used for the X-axis, change U/2 to U and X/2 to X.
- 3 A multiple repetitive canned cycle can be performed on any plane (including parallel axes for plane definition). When G-code system A is used, however, U, V, and W cannot be set as a parallel axis.

## 4.2.1 Stock Removal in Turning (G71)

There are two types of stock removals in turning : Type I and II.

### Format

ZpXp plane

**G71 U( $\Delta d$ ) R(e) ;**

**G71 P(ns) Q(nf) U( $\Delta u$ ) W( $\Delta w$ ) F(f) S(s) T(t) ;**

**N (ns) ;**  
 ...  
**N (nf) ;** } The move commands for the target figure from A to A' to B are specified in the blocks with sequence numbers ns to nf.

YpZp plane

**G71 W( $\Delta d$ ) R(e) ;**

**G71 P(ns) Q(nf) V( $\Delta w$ ) W( $\Delta u$ ) F(f) S(s) T(t) ;**

**N (ns) ;**

...

**N (nf) ;**

XpYp plane

**G71 V( $\Delta d$ ) R(e) ;**

**G71 P(ns) Q(nf) U( $\Delta w$ ) V( $\Delta u$ ) F(f) S(s) T(t) ;**

**N (ns) ;**

...

**N (nf) ;**

$\Delta d$  : Depth of cut

The cutting direction depends on the direction AA'. This designation is modal and is not changed until the other value is designated. Also this value can be specified by the parameter No. 5132, and the parameter is changed by the program command.

e : Escaping amount

This designation is modal and is not changed until the other value is designated. Also this value can be specified by the parameter No. 5133, and the parameter is changed by the program command.

ns : Sequence number of the first block for the program of finishing shape.

nf : Sequence number of the last block for the program of finishing shape.

$\Delta u$  : Distance of the finishing allowance in the direction of the second axis on the plane (X-axis for the ZX plane)

$\Delta w$  : Distance of the finishing allowance in the direction of the first axis on the plane (Z-axis for the ZX plane)

f,s,t : Any F, S, or T function contained in blocks ns to nf in the cycle is ignored, and the F, S, or T function in this G71 block is effective.

|            | Unit  | Diameter/radius programming | Sign         | Decimal point input |
|------------|---|-----------------------------|--------------|---------------------|
| $\Delta d$ | Depends on the increment system for the reference axis. | Radius programming          | Not required | Allowed             |
| e          | Depends on the increment system for the reference axis. | Radius programming          | Not required | Allowed             |

|            | Unit  | Diameter/radius programming  | Sign     | Decimal point input |
|------------|---|--|----------|---------------------|
| $\Delta u$ | Depends on the increment system for the reference axis. | Depends on diameter/radius programming for the second axis on the plane. | Required | Allowed             |
| $\Delta w$ | Depends on the increment system for the reference axis. | Depends on diameter/radius programming for the first axis on the plane.  | Required | Allowed             |

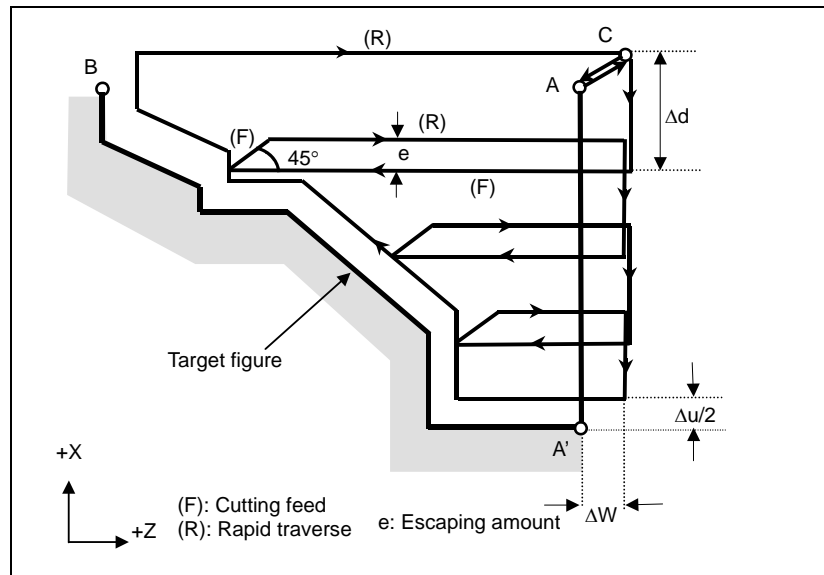

Fig. 4.2.1 (a) Cutting path in stock removal in turning (type I)

## Explanation

### - Operations

When a target figure passing through A, A', and B in this order is given by a program, the specified area is removed by  $\Delta d$  (depth of cut), with the finishing allowance specified by  $\Delta u/2$  and  $\Delta w$  left. After the last cutting is performed in the direction of the second axis on the plane (X-axis for the ZX plane), rough cutting is performed as finishing along the target figure. After rough cutting as finishing, the block next to the sequence block specified at Q is executed.

### NOTE

- 1 While both  $\Delta d$  and  $\Delta u$  are specified by the same address, the meanings of them are determined by the presence of addresses P and Q.
- 2 The cycle machining is performed by G71 command with P and Q specification.
- 3 F, S, and T functions which are specified in the move command between points A and B are ineffective and those specified in G71 block or the previous block are effective. M and second auxiliary functions are treated in the same way as F, S, and T functions.
- 4 When the constant surface speed control function is enabled (bit 0 (SSC) of parameter No. 8133 is set to 1), the G96 or G97 command specified in the move command between points A and B are ineffective, and that specified in G71 block or the previous block is effective.

### - Target figure Patterns

The following four cutting patterns are considered. All of these cutting cycles cut the workpiece with moving the tool in parallel to the first axis on the plane (Z-axis for the ZX plane). At this time, the signs of the finishing allowances of  $\Delta u$  and  $\Delta w$  are as follows:

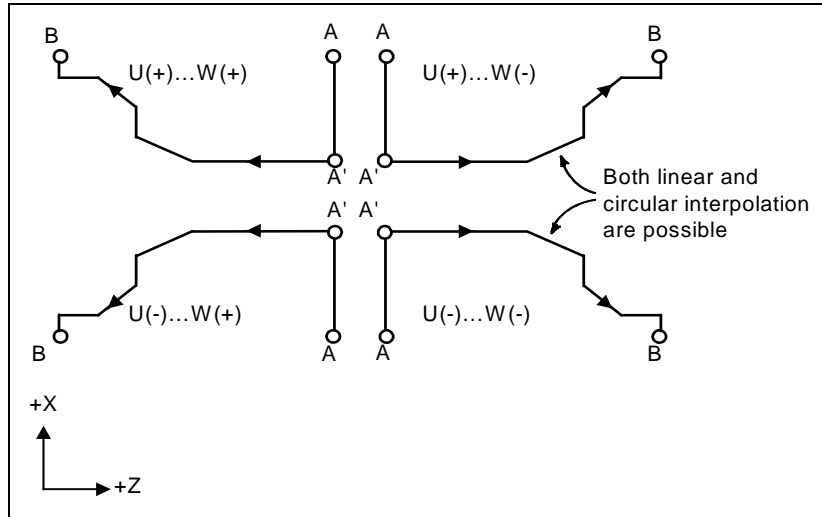

Fig. 4.2.1 (b) Four target figure patterns

**Limitation**

- (1) For U(+), a figure for which a position higher than the cycle start point is specified cannot be machined.  
For U(-), a figure for which a position lower than the cycle start point is specified cannot be machined.
- (2) For type I, the figure must show monotone increase or decrease along the first and second axes on the plane.
- (3) For type II, the figure must show monotone increase or decrease along the first axis on the plane.

**- Start block**

In the start block in the program for a target figure (block with sequence number ns in which the path between A and A' is specified), G00 or G01 must be specified. If it is not specified, alarm PS0065, "G00/G01 IS NOT IN THE FIRST BLOCK OF SHAPE PROGRAM" is issued.

When G00 is specified, positioning is performed along A-A'. When G01 is specified, linear interpolation is performed with cutting feed along A-A'.

In this start block, also select type I or II.

If X-axis does not move at start block, alarm PS0325 "UNAVAILABLE COMMAND IS IN SHAPE PROGRAM" is issued.

**- Check functions**

During cycle operation, whether the target figure shows monotone increase or decrease is always checked.

**NOTE**

When tool nose radius compensation is applied, the target figure to which compensation is applied is checked.

The following checks can also be made.

| Check  | Related parameter   |
|--|---|
| Checks that a block with the sequence number specified at address Q is contained in the program before cycle operation.                      | Enabled when bit 2 (QSR) of parameter No. 5102 is set to 1. |
| Checks the target figure before cycle operation.<br>(Also checks that a block with the sequence number specified at address Q is contained.) | Enabled when bit 2 (FCK) of parameter No. 5104 is set to 1. |

## - Types I and II

### Selection of type I or II

For G71, there are types I and II.

When the target figure has pockets, be sure to use type II.

Escaping operation after rough cutting in the direction of the first axis on the plane (Z-axis for the ZX plane) differs between types I and II. With type I, the tool escapes to the direction of 45 degrees. With type II, the tool cuts the workpiece along the target figure. When the target figure has no pockets, determine the desired escaping operation and select type I or II.

### NOTE

To use type II, the multiple repetitive canned cycle II option is required.

### Selecting type I or II

In the start block for the target figure (sequence number ns), select type I or II.

(1) When type I is selected

Specify the second axis on the plane (X-axis for the ZX plane). Do not specify the first axis on the plane (Z-axis for the ZX plane).

(2) When type II is selected

Specify the second axis on the plane (X-axis for the ZX plane) and first axis on the plane (Z-axis for the ZX plane).

When you want to use type II without moving the tool along the first axis on the plane (Z-axis for the ZX plane), specify the incremental programming with travel distance 0 (W0 for the ZX plane).

## - Type I

(1) In the block with sequence number ns, only the second axis on the plane (X-axis (U-axis) for the ZX plane) must be specified.

### Example

ZX plane

G71 U10.0 R5.0 ;

G71 P100 Q200.....;

**N100 X(U)\_ ;** (Specifies only the second axis on the plane.)

· ;  
· ;

N200.....;

(2) The figure along path A'-B must show monotone increase or decrease in the directions of both axes forming the plane (Z- and X-axes for the ZX plane). It must not have any pocket as shown in the Fig. 4.2.1 (c).

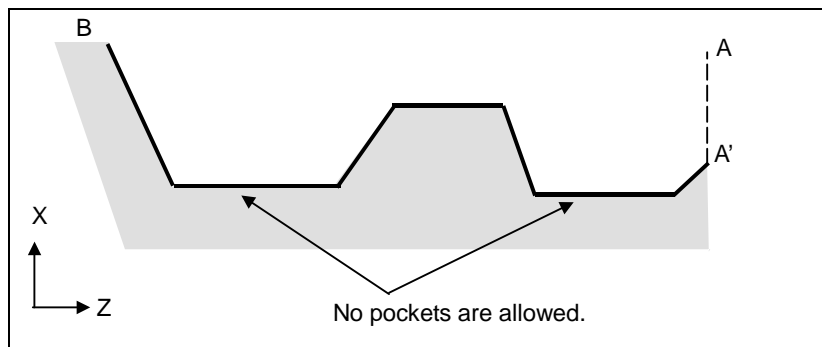

Fig. 4.2.1 (c) Figure which does not show monotone increase or decrease (type I)

**⚠ CAUTION**  
 If a figure does not show monotone change along the first or second axis on the plane, alarm PS0064, "THE FINISHING SHAPE IS NOT A MONOTONOUS CHANGE(FIRST AXES)" or PS0329, "THE FINISHING SHAPE IS NOT A MONOTONOUS CHANGE(SECOND AXES)" is issued. If the movement does not show monotone change, but is very small, and it can be determined that the movement is not dangerous, however, the permissible amount can be specified in parameters Nos. 5145 and 5146 to specify that the alarm is not issued in this case.

- (3) The tool escapes to the direction of 45 degrees in cutting feed after rough cutting.

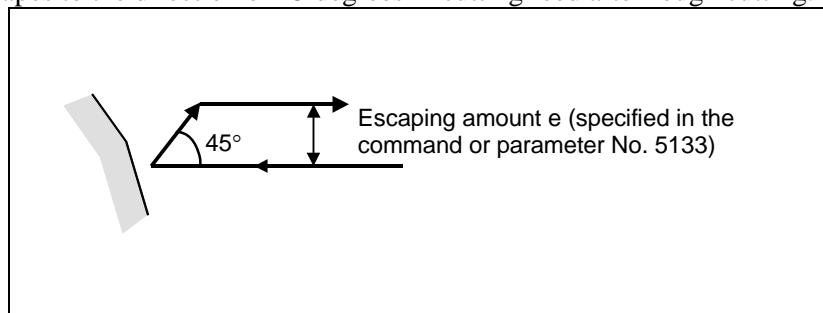

Fig. 4.2.1 (d) Cutting in the direction of 45 degrees (type I)

- (4) Immediately after the last cutting, rough cutting is performed as finishing along the target figure. Bit 1 (RF1) of parameter No. 5105 can be set to 1 so that rough cutting as finishing is not performed.

- **Type II**

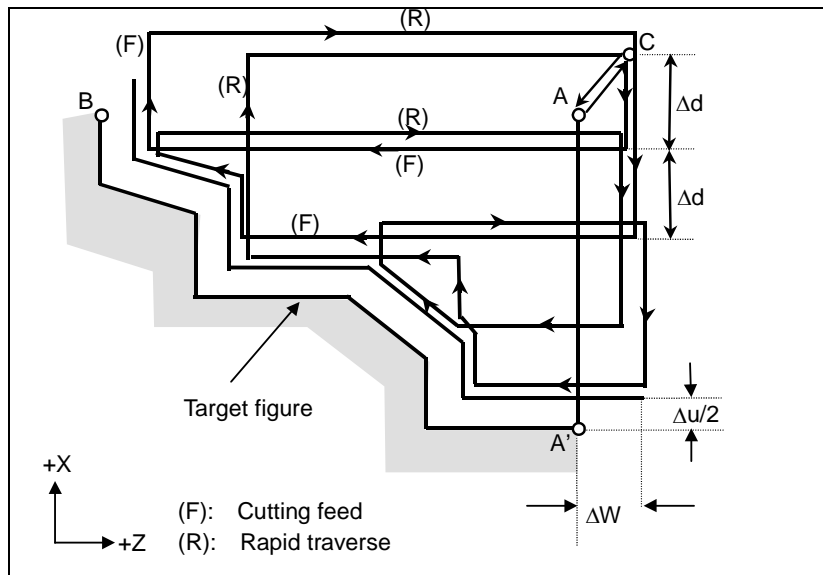

Fig. 4.2.1 (e) Cutting path in stock removal in turning (type II)

When a target figure passing through A, A', and B in this order is given by the program for a target figure as shown in the Fig. 4.2.1 (e), the specified area is removed by  $\Delta d$  (depth of cut), with the finishing allowance specified by  $\Delta u/2$  and  $\Delta w$  left. Type II differs from type I in cutting the workpiece along the figure after rough cutting in the direction of the first axis on the plane (Z-axis for the ZX plane).

After the last cutting, the tool returns to the start point specified in G71 and rough cutting is performed as finishing along the target figure, with the finishing allowance specified by  $\Delta u/2$  and  $\Delta w$  left.

Type II differs from type I in the following points:

- (1) In the block with sequence number ns, the two axes forming the plane (X-axis (U-axis) and Z-axis (W-axis) for the ZX plane) must be specified. When you want to use type II without moving the tool along the Z-axis on the ZX plane in the first block, specify W0.

**Example**

```
ZX plane
G71 U10.0 R5.0;
G71 P100 Q200.....;
N100 X(U)_ Z(W)_ ; (Specifies the two axes forming the plane.)
      : ;
      : ;
      : ;
N200.....;
```

- (2) The figure need not show monotone increase or decrease in the direction of the second axis on the plane (X-axis for the ZX plane) and it may have concaves (pockets).

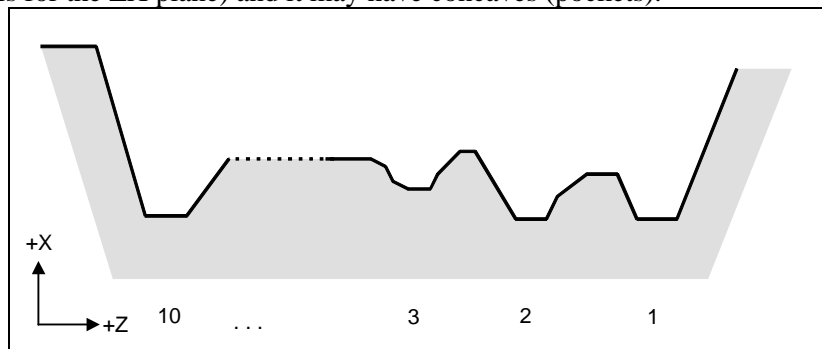

Fig. 4.2.1 (f) Figure having pockets (type II)

The figure must show monotone change in the direction of the first axis on the plane (Z-axis for the ZX plane), however. The Fig. 4.2.1 (g) cannot be machined.

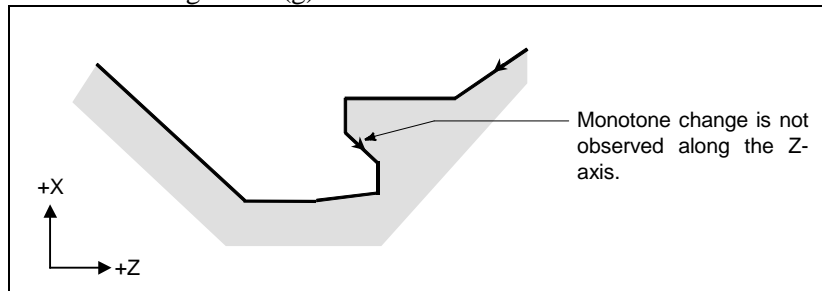

Fig. 4.2.1 (g) Figure which cannot be machined (type II)

**⚠ CAUTION**

For a figure along which the tool moves backward along the first axis on the plane during cutting operation (including a vertex in an arc command), the cutting tool may contact the workpiece. For this reason, for a figure which does not show monotone change, alarm PS0064 "THE FINISHING SHAPE IS NOT A MONOTONOUS CHANGE(FIRST AXES)" is issued. If the movement does not show monotone change, but is very small, and it can be determined that the movement is not dangerous, however, the permissible amount can be specified in parameter No. 5145 to specify that the alarm is not issued in this case.

The first cut portion need not be vertical. Any figure is permitted if monotone change is shown in the direction of the first axis on the plane (Z-axis for the ZX plane).

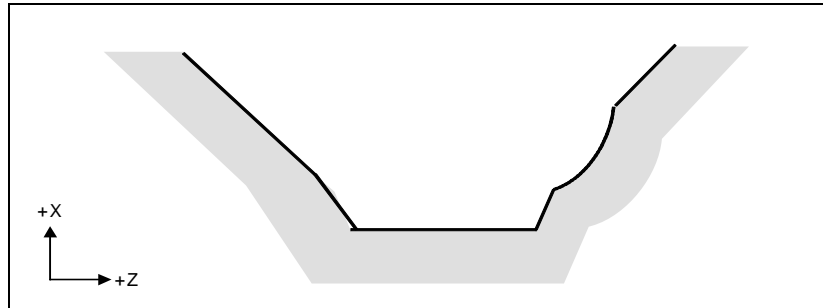

Fig. 4.2.1 (h) Figure which can be machined (type II)

- (3) After turning, the tool cuts the workpiece along its figure and escapes in cutting feed.

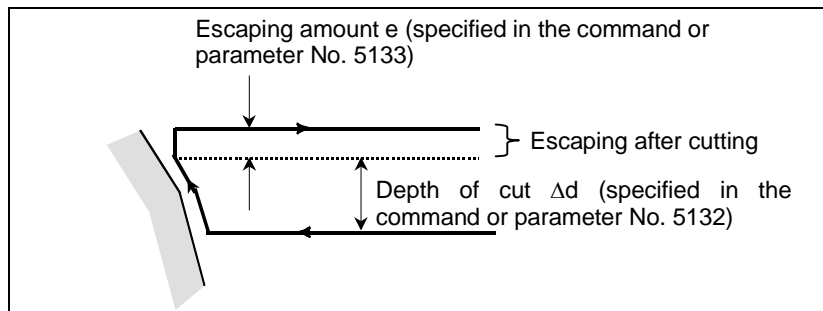

Fig. 4.2.1 (i) Cutting along the workpiece figure (type II)

The escaping amount after cutting ( $e$ ) can be specified at address R or set in parameter No. 5133. When moving from the bottom, however, the tool escapes to the direction of 45 degrees.

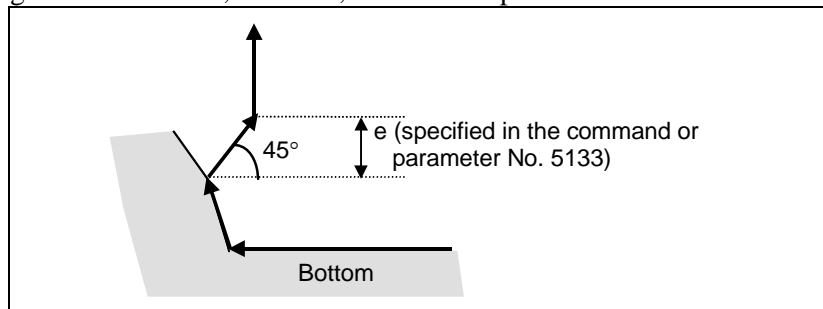

Fig. 4.2.1 (j) Escaping from the bottom to the direction of 45 degrees

- (4) When a position parallel to the first axis on the plane (Z-axis for the ZX plane) is specified in a block in the program for the target figure, it is assumed to be at the bottom of a pocket.
- (5) After all rough cutting terminates along the first axis on the plane (Z-axis for the ZX plane), the tool temporarily returns to the cycle start point. At this time, when there is a position whose height equals to that at the start point, the tool passes through the point in the position obtained by adding depth of cut  $\Delta d$  to the position of the figure and returns to the start point. Then, rough cutting is performed as finishing along the target figure. At this time, the tool passes through the point in the obtained position (to which depth of cut  $\Delta d$  is added) when returning to the start point.  
Bit 2 (RF2) of parameter No. 5105 can be set to 1 so that rough cutting as finishing is not performed.



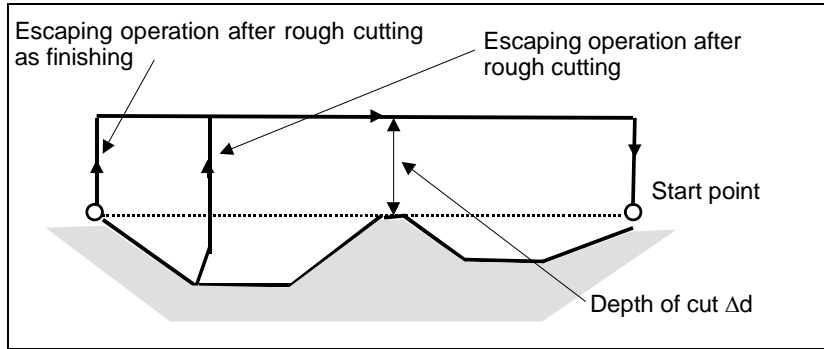

Fig. 4.2.1 (k) Escaping operation when the tool returns to the start point (type II)

(6) Order and path for rough cutting of pockets

Rough cutting is performed in the following order.

- (a) When the figure shows monotone decrease along the first axis on the plane (Z-axis for the ZX plane)

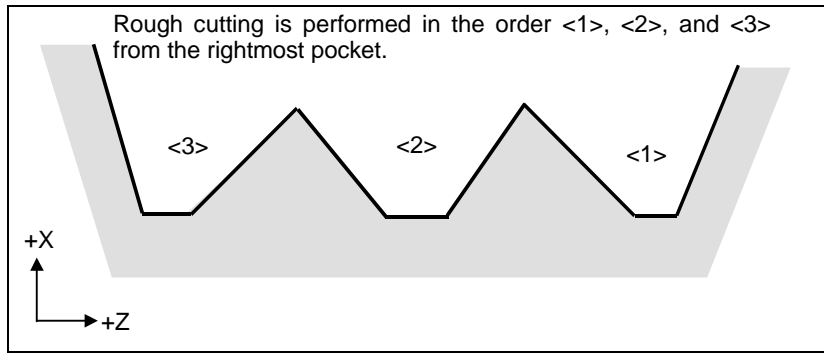

Fig. 4.2.1 (l) Rough cutting order in the case of monotone decrease (type II)

- (b) When the figure shows monotone increase along the first axis on the plane (Z-axis for the ZX plane)

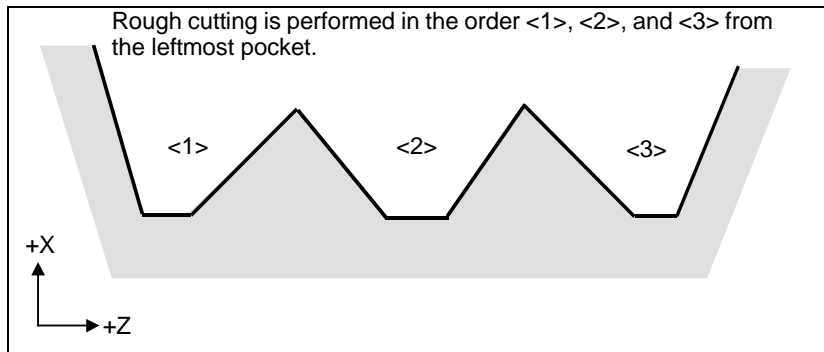

Fig. 4.2.1 (m) Rough cutting order in the case of monotone increase (type II)

The path in rough cutting is as shown Fig. 4.2.1 (n).

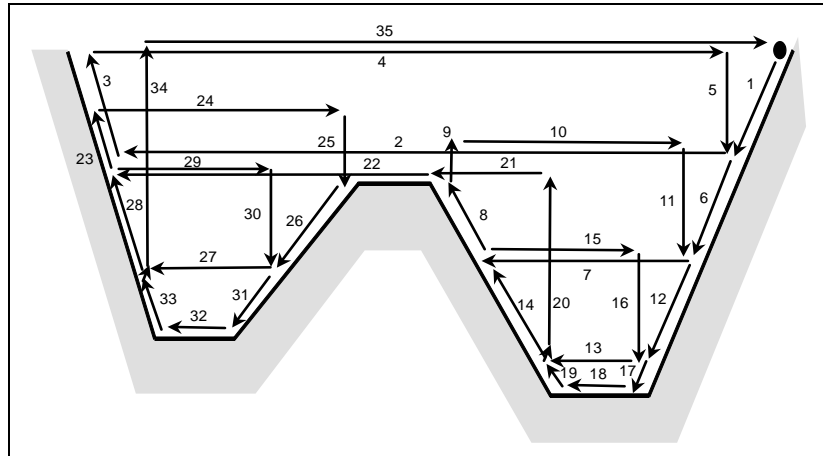

Fig. 4.2.1 (n) Cutting path for multiple pockets (type II)

The following figure shows how the tool moves after rough cutting for a pocket in detail.

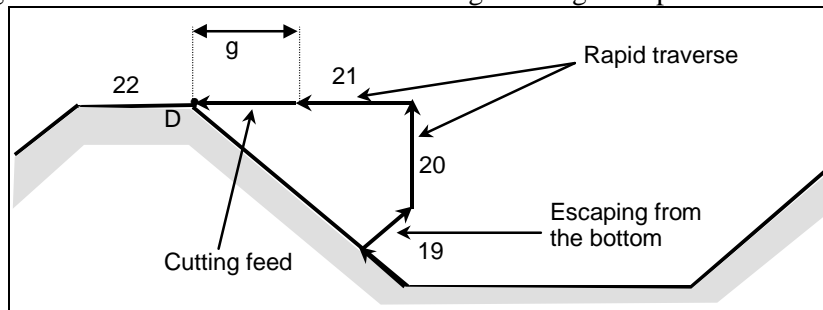

Fig. 4.2.1 (o) Details of motion after cutting for a pocket (type II)

Cuts the workpiece at the cutting feedrate and escapes to the direction of 45 degrees. (Operation 19)

Then, moves to the height of point D in rapid traverse. (Operation 20)

Then, moves to the position the amount of g before point D. (Operation 21)

Finally, moves to point D in cutting feed.

The clearance g to the cutting feed start position is set in parameter No. 5134.

For the last pocket, after cutting the bottom, the tool escapes to the direction of 45 degrees and returns to the start point in rapid traverse. (Operations 34 and 35)

**⚠ CAUTION**

- 1 This CNC differs from the FANUC Series 0i-C in cutting of a pocket. The tool first cuts the nearest pocket to the start point. After cutting of the pocket terminates, the tool moves to the nearest but one pocket and starts cutting.
- 2 When the figure has a pocket, generally specify a value of 0 for  $\Delta w$  (finishing allowance). Otherwise, the tool may dig into the wall on one side.

This CNC differs from the FANUC Series 0i-C in the path of cutting after turning depending on the figure of the workpiece. When the tool becomes moving only along the first axis on the plane (Z-axis for the ZX plane) according to the figure of the workpiece during cutting, it starts retraction along the second axis on the plane (X-axis for the ZX plane).

When bit 0 (R16) of parameter No. 5108 is set to 1, the cutting can be continued along the first axis on the plane.

The cutting path that the target figure program of Fig. 4.2.1 (n) is executed by the setting of bit 0 (R16) of parameter No. 5108, is shown in Fig. 4.2.1 (p).

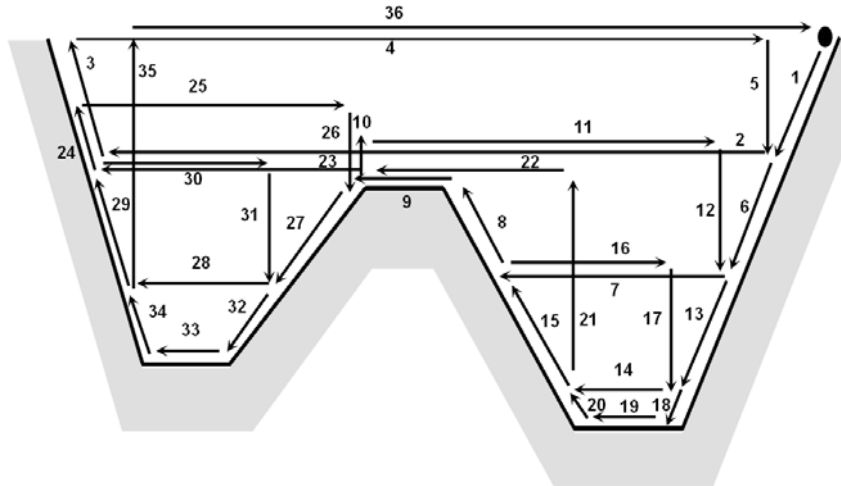

Fig. 4.2.1 (p) Cutting path (No.5108#0 is set to 1)

**- Tool nose radius compensation**

When using tool nose radius compensation, specify a tool nose radius compensation command (G41, G42) before a multiple repetitive canned cycle command (G70, G71, G72, G73) and specify the cancel command (G40) outside the programs (from the block specified with P to the block specified with Q) specifying a target finishing figure.

If tool nose radius compensation is specified in the program specifying a target finishing figure, alarm PS0325, "UNAVAILABLE COMMAND IS IN SHAPE PROGRAM", is issued.

**Program example**

G42;.....Specify this command before a multiple repetitive canned cycle command.

G71U1.0R0.5;

G71P10Q20;

N10G00X0;

:

N20X50.0;

G40;.....Specify this command after the program specifying a target finishing figure.

When this cycle is specified in the tool nose radius compensation mode, offset is temporarily canceled during movement to the start point. Start-up is performed in the first block. Offset is temporarily canceled again at the return to the cycle start point after termination of cycle operation. Start-up is performed again according to the next move command. This operation is shown in the Fig. 4.2.1 (q).

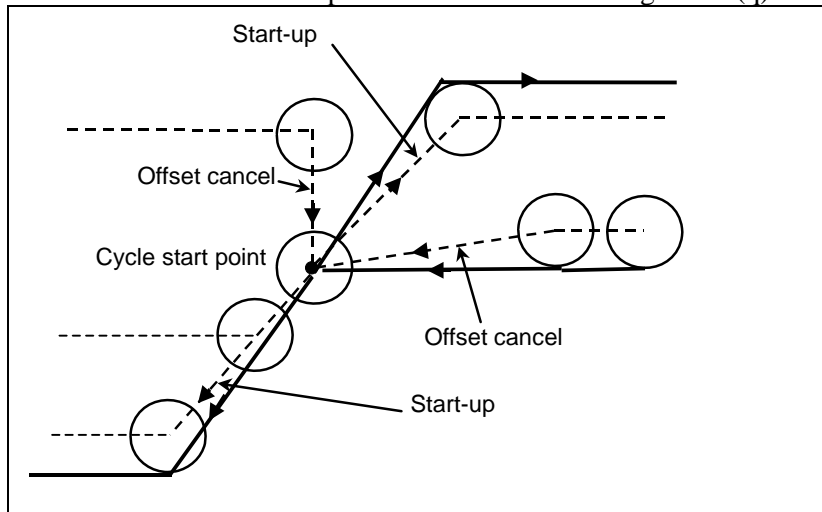

Fig. 4.2.1 (q)

This cycle operation is performed according to the figure determined by the tool nose radius compensation path when the offset vector is 0 at start point A and start-up is performed in a block between path A-A'.

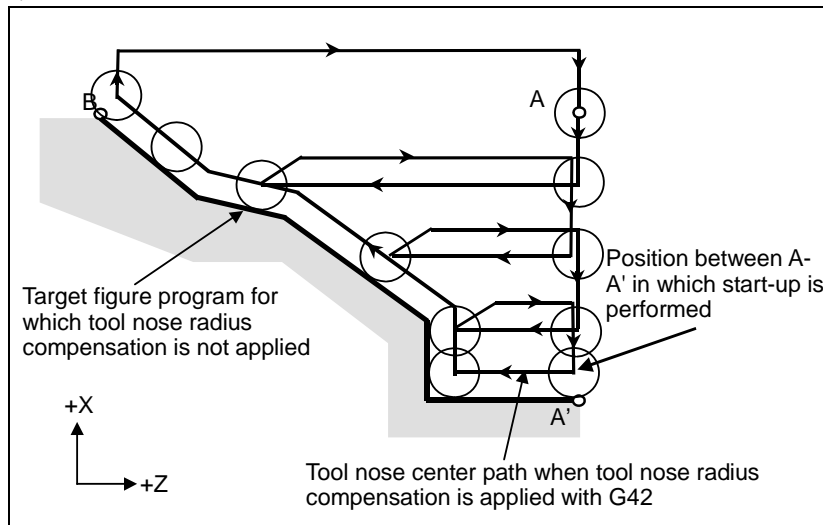

Fig. 4.2.1 (r) Path when tool nose radius compensation is applied

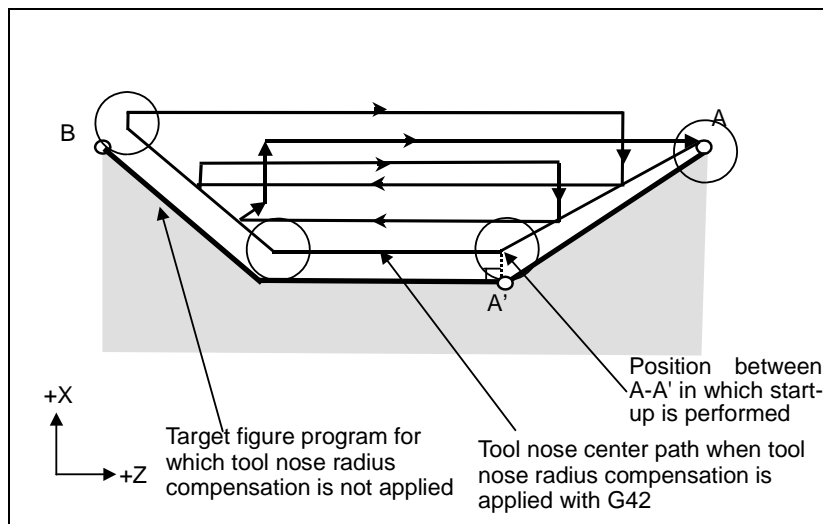

Fig. 4.2.1 (s)

**NOTE**

To perform pocketing in the tool nose radius compensation mode, specify the linear block A-A' outside the workpiece and specify the figure of an actual pocket. This prevents a pocket from being dug.

When the bit 2 (NT1) of parameter No. 5106 is set to 1, the tool nose radius compensation G40/G41/G42 commanded in the target figure program of the multiple repetitive cycle G71/G72/G73 is ignored and no alarm is occurred.

When the bit 3 (NT2) of parameter No. 5106 is set to 1, the tool nose radius compensation commanded in the target figure program of the multiple repetitive cycle G70 is valid. However there is following limitations.

- (1) The tool nose radius compensation cancel G40 is selected as the modal when the finishing cycle G70 is commanded.

If the tool nose radius compensation is commanded in the target figure program when G41/G42 is selected as the modal at the finishing cycle G70 command, the alarm PS0325 "UNAVAILABLE COMMAND IS IN SHAPE PROGRAM" is occurred.

- (2) Do not command G41/G42 excluding the end block in the target figure program.  
If G41 or G42 is specified at the last block of the target figure program, the PS0325 alarm (UNAVAILABLE COMMAND IS IN SHAPE PROGRAM) is issued.
- (3) Command G40 at the last block of the target figure program (commanded by Q address)  
If G40 is not commanded at the last block of the target figure program when G41 or G42 is commanded at the first block, the PS0538 alarm "OFFSET IS NOT CANCELED" is occurred.

Program example of the tool nose radius compensation in the target figure of G70)

```
G40 ;
G70 P10 Q20 ... ;
N10 G41 ... ;
:
N20 G40 ... ;
```

**- Reducing the cycle time**

In the multiple repetitive cycle G71/G72 of type I , if bit 1 (DTP) of parameter No. 5108 is set to 1, the tool return to the cycle start point directly from the end point of the finishing program after rough cutting of the finishing shape program is finished.

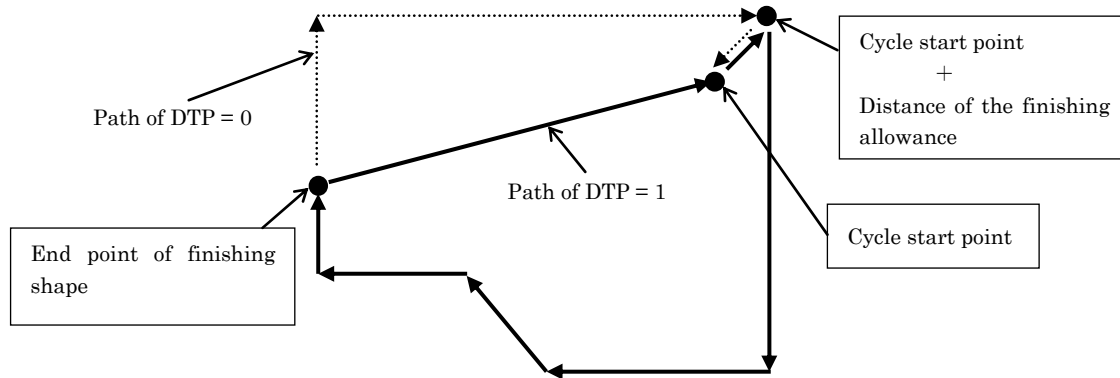

Fig. 4.2.1 (t) Return to cycle start point

In the multiple repetitive cycle G71/G72 of type II, when bit 3 (NSP) of parameter No. 5108 is set to 1, the cutting is executed not to repeat the same cutting path. (When bit 3 (NSP) of parameter No. 5108 is set to 1, the operation of bit 0 (R16) of parameter No. 5108 = 1 is always selected.)

- Case of target figure without pocket.  
In the conventional method, the path AB is cut twice as Fig. 4.2.1 (w).  
When bit 3 (NSP) of parameter No. 5108 is set to 1, the overlap is avoided as Fig. 4.2.1(x).

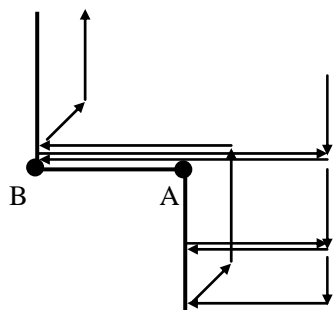

Fig. 4.2.1 (u) Target figure without pocket (No.5108#3=0)

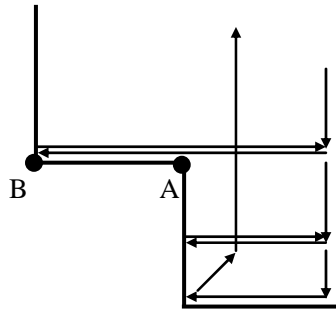

Fig. 4.2.1 (v) Target figure without pocket (No.5108#3=1)

- Case of target figure with pocket.

In the conventional method, the path AB and CD are cut twice as Fig. 4.2.1 (y).

The cutting path when bit 3 (NSP) of parameter No. 5108 is set to 1 is shown in Fig. 4.2.1(z). The path AB is overlapped as same as Fig. 4.2.1 (y), however the path AB is executed by rapid traverse at second times. The overlap path CD is avoided.

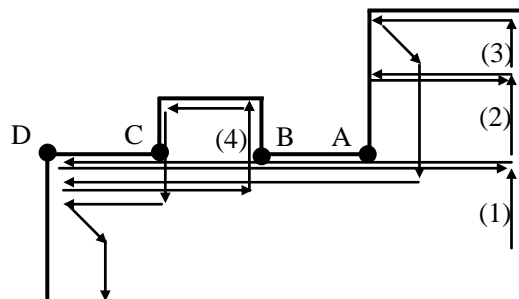

Fig. 4.2.1 (w) Target figure with pocket (No.5108#3=0)

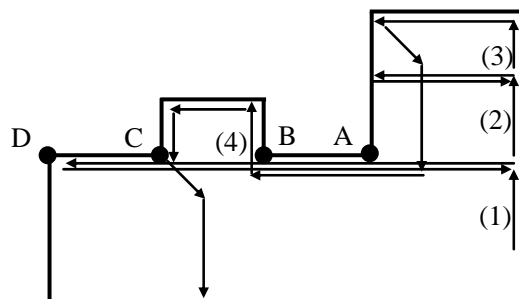

Fig. 4.2.1 (x) Target figure with pocket (No.5108#3=1)

- Case of consecutive pockets

In the conventional method, the tool moves to point I after finish the cutting of a pocket and positioning to the start point of a next pocket as Fig. 4.2.1 (aa). In this way, the path is overlapped at BI, DI, FI and HI.

The cutting path when bit 3 (NSP) of parameter No. 5108 is set to 1 is shown in Fig. 4.2.1(bb). The movement to point I is executed just first time and then the pocket cutting is executed one after another.

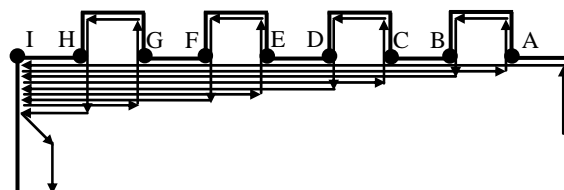

Fig. 4.2.1 (y) Consecutive pockets (No.5108#3=0)

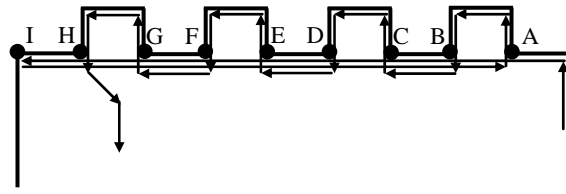

Fig. 4.2.1 (z) Consecutive pockets (No.5108#3=1)

## 4.2.2 Stock Removal in Facing (G72)

This cycle is the same as G71 except that cutting is performed by an operation parallel to the second axis on the plane (X-axis for the ZX plane).

### Format

ZpXp plane

**G72 W( $\Delta d$ ) R(e) ;**

**G72 P(ns) Q(nf) U( $\Delta u$ ) W( $\Delta w$ ) F(f) S(s) T(t) ;**

**N (ns) ;**  
 ...  
**N (nf) ;** } The move commands for the target figure from A to A' to B are specified in the blocks with sequence numbers ns to nf.

YpZp plane

**G72 V( $\Delta d$ ) R(e) ;**

**G72 P(ns) Q(nf) V( $\Delta w$ ) W( $\Delta u$ ) F(f) S(s) T(t) ;**

**N (ns) ;**

...

**N (nf) ;**

XpYp plane

**G72 U( $\Delta d$ ) R(e) ;**

**G72 P(ns) Q(nf) U( $\Delta w$ ) V ( $\Delta u$ ) F(f) S(s) T(t) ;**

**N (ns) ;**

...

**N (nf) ;**

$\Delta d$  : Depth of cut

The cutting direction depends on the direction AA'. This designation is modal and is not changed until the other value is designated. Also this value can be specified by the parameter No. 5132, and the parameter is changed by the program command.

e : Escaping amount

This designation is modal and is not changed until the other value is designated. Also this value can be specified by the parameter No. 5133, and the parameter is changed by the program command.

ns : Sequence number of the first block for the program of finishing shape.

nf : Sequence number of the last block for the program of finishing shape.

$\Delta u$  : Distance of the finishing allowance in the direction of the second axis on the plane (X-axis for the ZX plane)

$\Delta w$  : Distance of the finishing allowance in the direction of the first axis on the plane (Z-axis for the ZX plane)

f,s,t : Any F, S, or T function contained in blocks ns to nf in the cycle is ignored, and the F, S, or T function in this G72 block is effective.

|            | Unit  | Diameter/radius programming | Sign         | Decimal point input |
|------------|---|-----------------------------|--------------|---------------------|
| $\Delta d$ | Depends on the increment system for the reference axis. | Radius programming          | Not required | Allowed             |
| e          | Depends on the increment system for the reference axis. | Radius programming          | Not required | Allowed             |



|            | Unit  | Diameter/radius programming  | Sign     | Decimal point input |
|------------|---|--|----------|---------------------|
| $\Delta u$ | Depends on the increment system for the reference axis. | Depends on diameter/radius programming for the second axis on the plane. | Required | Allowed             |
| $\Delta w$ | Depends on the increment system for the reference axis. | Depends on diameter/radius programming for the first axis on the plane.  | Required | Allowed             |

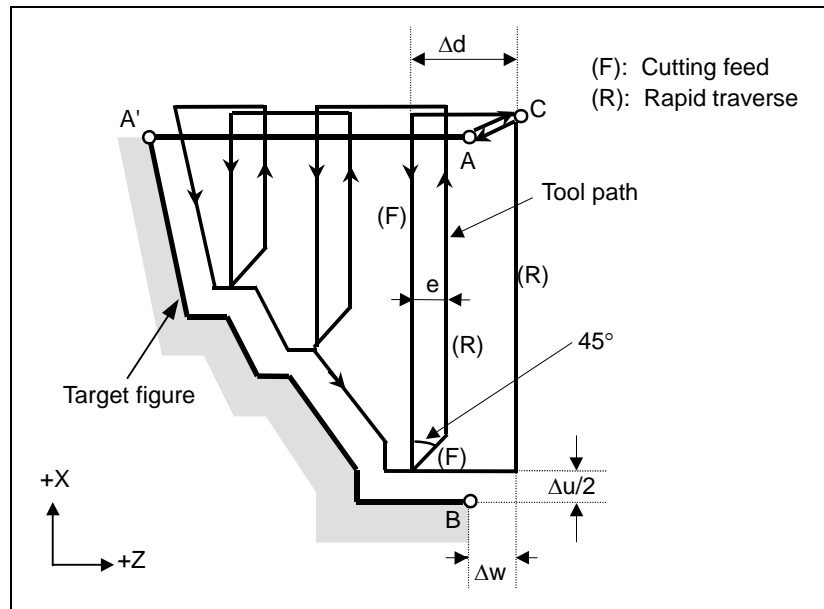

Fig. 4.2.2 (a) Cutting path in stock removal in facing (type I)

## Explanation

### - Operations

When a target figure passing through A, A', and B in this order is given by a program, the specified area is removed by  $\Delta d$  (depth of cut), with the finishing allowance specified by  $\Delta u/2$  and  $\Delta w$  left.

### NOTE

- 1 While both  $\Delta d$  and  $\Delta u$  are specified by the same address, the meanings of them are determined by the presence of addresses P and Q.
- 2 The cycle machining is performed by G72 command with P and Q specification.
- 3 F, S, and T functions which are specified in the move command between points A and B are ineffective and those specified in G72 block or the previous block are effective. M and second auxiliary functions are treated in the same way as F, S, and T functions.
- 4 When the constant surface speed control function is enabled (bit 0 (SSC) of parameter No. 8133 is set to 1), G96 or G97 command specified in the move command between points A and B are ineffective, and that specified in G72 block or the previous block is effective.

### - Target figure Patterns

The following four cutting patterns are considered. All of these cutting cycles cut the workpiece with moving the tool in parallel to the second axis on the plane (X-axis for the ZX plane). At this time, the signs of the finishing allowances of  $\Delta u$  and  $\Delta w$  are as follows:

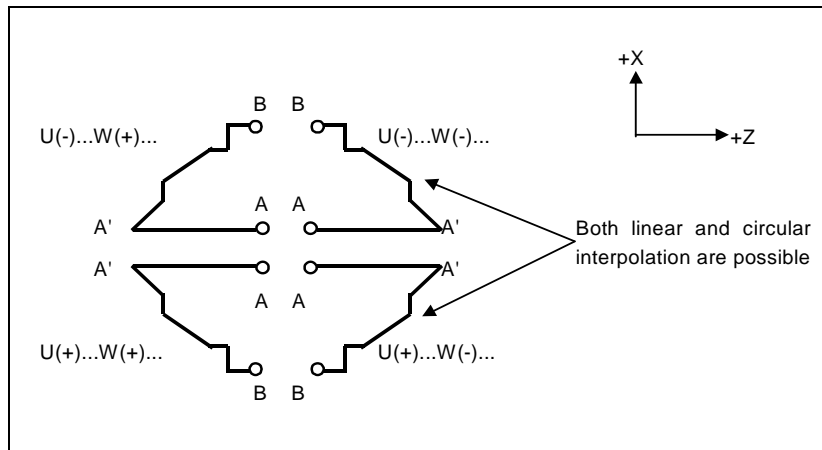

Fig. 4.2.2 (b) Signs of the values specified at U and W in stock removal in facing

**Limitation**

- (1) For W(+), a figure for which a position higher than the cycle start point is specified cannot be machined.  
For W(-), a figure for which a position lower than the cycle start point is specified cannot be machined.
- (2) For type I, the figure must show monotone increase or decrease along the first and second axes on the plane.
- (3) For type II, the figure must show monotone increase or decrease along the second axis on the plane.

**- Start block**

In the start block in the program for a target figure (block with sequence number ns in which the path between A and A' is specified), G00 or G01 must be specified. If it is not specified, alarm PS0065, "G00/G01 IS NOT IN THE FIRST BLOCK OF SHAPE PROGRAM" is issued.

When G00 is specified, positioning is performed along A-A'. When G01 is specified, linear interpolation is performed with cutting feed along A-A'.

In this start block, also select type I or II.

If Z-axis does not move at start block, alarm PS0325 "UNAVAILABLE COMMAND IS IN SHAPE PROGRAM" is issued.

**- Check functions**

During cycle operation, whether the target figure shows monotone increase or decrease is always checked.

**NOTE**

When tool nose radius compensation is applied, the target figure to which compensation is applied is checked.

The following checks can also be made.

| Check  | Related parameter   |
|--|---|
| Checks that a block with the sequence number specified at address Q is contained in the program before cycle operation.                      | Enabled when bit 2 (QSR) of parameter No. 5102 is set to 1. |
| Checks the target figure before cycle operation.<br>(Also checks that a block with the sequence number specified at address Q is contained.) | Enabled when bit 2 (FCK) of parameter No. 5104 is set to 1. |

## - Types I and II

### Selection of type I or II

For G72, there are types I and II.

When the target figure has pockets, be sure to use type II.

Escaping operation after rough cutting in the direction of the second axis on the plane (X-axis for the ZX plane) differs between types I and II. With type I, the tool escapes to the direction of 45 degrees. With type II, the tool cuts the workpiece along the target figure. When the target figure has no pockets, determine the desired escaping operation and select type I or II.

### Selecting type I or II

In the start block for the target figure (sequence number ns), select type I or II.

(1) When type I is selected

Specify the first axis on the plane (Z-axis for the ZX plane). Do not specify the second axis on the plane (X-axis for the ZX plane).

(2) When type II is selected

Specify the second axis on the plane (X-axis for the ZX plane) and first axis on the plane (Z-axis for the ZX plane).

When you want to use type II without moving the tool along the second axis on the plane (X-axis for the ZX plane), specify the incremental programming with travel distance 0 (U0 for the ZX plane).

## - Type I

G72 differs from G71 in the following points:

(1) G72 cuts the workpiece with moving the tool in parallel with the second axis on the plane (X-axis on the ZX plane).

(2) In the start block in the program for a target figure (block with sequence number ns), only the first axis on the plane (Z-axis (W-axis) for the ZX plane) must be specified.

## - Type II

G72 differs from G71 in the following points:

(1) G72 cuts the workpiece with moving the tool in parallel with the second axis on the plane (X-axis on the ZX plane).

(2) The figure need not show monotone increase or decrease in the direction of the first axis on the plane (Z-axis for the ZX plane) and it may have concaves (pockets). The figure must show monotone change in the direction of the second axis on the plane (X-axis for the ZX plane), however.

(3) When a position parallel to the second axis on the plane (X-axis for the ZX plane) is specified in a block in the program for the target figure, it is assumed to be at the bottom of a pocket.

(4) After all rough cutting terminates along the second axis on the plane (X-axis for the ZX plane), the tool temporarily returns to the start point. Then, rough cutting as finishing is performed.

## - Tool nose radius compensation

See the pages on which G71 is explained.

## - Reducing the cycle time

See the pages on which G71 is explained.

### 4.2.3 Pattern Repeating (G73)

This function permits cutting a fixed pattern repeatedly, with a pattern being displaced bit by bit. By this cutting cycle, it is possible to efficiently cut work whose rough shape has already been made by a rough machining, forging or casting method, etc.

#### Format

ZpXp plane

**G73 W( $\Delta k$ ) U( $\Delta i$ ) R(d) ;**

**G73 P(ns) Q(nf) U( $\Delta u$ ) W( $\Delta w$ ) F(f) S(s) T(t) ;**

**N (ns) ;**  
 ...  
**N (nf) ;** } The move commands for the target figure from A  
 to A' to B are specified in the blocks with  
 sequence numbers ns to nf.

YpZp plane

**G73 V( $\Delta k$ ) W( $\Delta i$ ) R(d) ;**

**G73 P(ns) Q(nf) V( $\Delta w$ ) W( $\Delta u$ ) F(f) S(s) T(t) ;**

**N (ns) ;**

...

**N (nf) ;**

XpYp plane

**G73 U( $\Delta k$ ) V( $\Delta i$ ) R(d) ;**

**G73 P(ns) Q(nf) U( $\Delta w$ ) V( $\Delta u$ ) F(f) S(s) T(t) ;**

**N (ns) ;**

...

**N (nf) ;**

$\Delta i$  : Distance of escape in the direction of the second axis on the plane (X-axis for the ZX plane)

This designation is modal and is not changed until the other value is designated. Also this value can be specified by the parameter No. 5135, and the parameter is changed by the program command.

$\Delta k$  : Distance of escape in the direction of the first axis on the plane (Z-axis for the ZX plane)

This designation is modal and is not changed until the other value is designated. Also this value can be specified by the parameter No. 5136, and the parameter is changed by the program command.

d : The number of division

This value is the same as the repetitive count for rough cutting. This designation is modal and is not changed until the other value is designated. Also, this value can be specified by the parameter No. 5137, and the parameter is changed by the program command.

ns : Sequence number of the first block for the program of finishing shape.

nf : Sequence number of the last block for the program of finishing shape.

$\Delta u$  : Distance of the finishing allowance in the direction of the second axis on the plane (X-axis for the ZX plane)

$\Delta w$  : Distance of the finishing allowance in the direction of the first axis on the plane (Z-axis for the ZX plane)

f, s, t : Any F, S, and T function contained in the blocks between sequence number "ns" and "nf" are ignored, and the F, S, and T functions in this G73 block are effective.

|            | Unit  | Diameter/radius programming  | Sign     | Decimal point input |
|------------|---|--|----------|---------------------|
| $\Delta i$ | Depends on the increment system for the reference axis. | Radius programming   | Required | Allowed             |
| $\Delta k$ | Depends on the increment system for the reference axis. | Radius programming   | Required | Allowed             |
| $\Delta u$ | Depends on the increment system for the reference axis. | Depends on diameter/radius programming for the second axis on the plane. | Required | Allowed             |
| $\Delta w$ | Depends on the increment system for the reference axis. | Depends on diameter/radius programming for the first axis on the plane.  | Required | Allowed             |

**NOTE**

Decimal point input is allowed with d. However, a value rounded off to an integer is used as the number of division, regardless of the setting of bit 0 (DPI) of parameter No. 3401. When an integer is input, the input integer is used as the number of division.

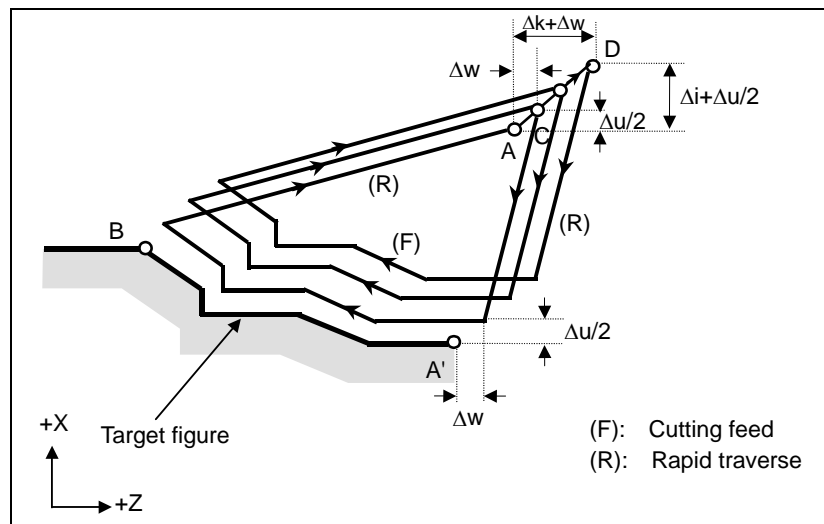

Fig. 4.2.3 (a) Cutting path in pattern repeating

**Explanation****- Operations**

When a target figure passing through A, A', and B in this order is given by a program, rough cutting is performed the specified number of times, with the finishing allowance specified by  $\Delta u/2$  and  $\Delta w$  left.

**NOTE**

- 1 While the values  $\Delta i$  and  $\Delta k$ , or  $\Delta u$  and  $\Delta w$  are specified by the same address respectively, the meanings of them are determined by the presence of addresses P and Q.
- 2 The cycle machining is performed by G73 command with P and Q specification.
- 3 After cycle operation terminates, the tool returns to point A.
- 4 F, S, and T functions which are specified in the move command between points A and B are ineffective and those specified in G73 block or the previous block are effective. M and second auxiliary functions are treated in the same way as F, S, and T functions.

**- Target figure  
Patterns**

As in the case of G71, there are four target figure patterns. Be careful about signs of  $\Delta u$ ,  $\Delta w$ ,  $\Delta i$ , and  $\Delta k$  when programming this cycle.

**- Start block**

In the start block in the program for the target figure (block with sequence number ns in which the path between A and A' is specified), G00 or G01 must be specified. If it is not specified, alarm PS0065, "G00/G01 IS NOT IN THE FIRST BLOCK OF SHAPE PROGRAM" is issued.

When G00 is specified, positioning is performed along A-A'. When G01 is specified, linear interpolation is performed with cutting feed along A-A'.

**- Check function**

The following check can be made.

| Check   | Related parameter   |
|---|---|
| Checks that a block with the sequence number specified at address Q is contained in the program before cycle operation. | Enabled when bit 2 (QSR) of parameter No. 5102 is set to 1. |

**- Tool nose radius compensation**

Like G71, this cycle operation is performed according to the figure determined by the tool nose radius compensation path when the offset vector is 0 at start point A and start-up is performed in a block between path A-A'.

**- Single block operation**

The single block stop position can be selected by setting of bit 2 (PRS) of parameter No. 5125.

When bit 2 (PRS) of parameter No. 5125 is set to 0, the stop position of single block operation are the end point of each cycles and the end point of each blocks in the finishing shape.

When bit 2 (PRS) of parameter No. 5125 is set to 1, the stop position of single block operation are the end point of each cycles and the end point of escape from the cycle start point. (FS16i compatible specification)

It explains that the movement when the O0001 shown in Fig. 4.2.3 (b) is executed by the single block operation.

The finishing shape specified by N10-N30 of the O0001 is shown in Fig. 4.2.3 (c).

```
O0001;
G00X100.0Z0.0;
G73U6.0W6.0R3.0;
G73P10Q30U6.0W3.0F1.0S500;
N10G00X60.0W0.0;
N15G01Z-10.0;
N20G02X80.0Z-20.0R10.0;
N30G01X100.0;
M30;
```

Fig. 4.2.3 (b) Sample program

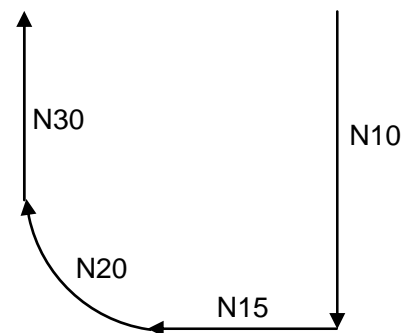

Fig. 4.2.3 (c) Finishing shape of O0001

When bit 2 (PRS) of parameter No. 5125 is set to 0, in case the O0001 is executed by the single block operation, the stop position of single block operation are the end point of each cycles and the end point of each blocks in the finishing shape as shown in Fig. 4.2.3 (d). The single block stop does not executed at the end point of escape from the cycle start point.

When bit 2 (PRS) of parameter No. 5125 is set to 1, in case the O0001 is executed by the single block operation, the stop position of single block operation are the end point of each cycles and the end point of escape from the cycle start point as shown in Fig. 4.2.3 (e).

“S” in following figures stands for the single stop position.

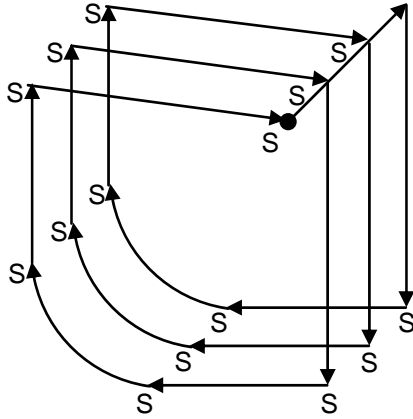

Fig. 4.2.3 (d) PRS(No.5125#2)=0

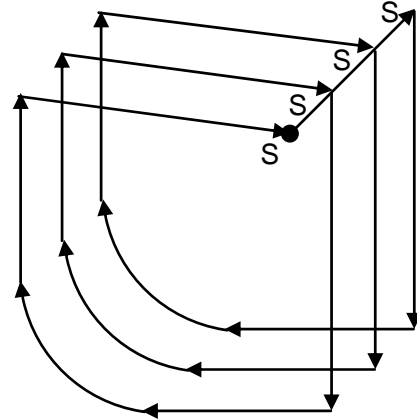

Fig. 4.2.3 (e) PRS(No.5125#2)=1

## 4.2.4 Finishing Cycle (G70)

After rough cutting by G71, G72 or G73, the following command permits finishing.

### Format

**G70 P(ns) Q(nf) ;**

ns : Sequence number of the first block for the program of finishing shape.

nf : Sequence number of the last block for the program of finishing shape.

### Explanation

#### - Operations

The blocks with sequence numbers ns to nf in the program for a target figure are executed for finishing. The F, S, T, M, and second auxiliary functions specified in the G71, G72, or G73 block are ignored and the F, S, T, M, and second auxiliary functions specified in the blocks with sequence numbers ns to nf are effective.

When cycle operation terminates, the tool is returned to the start point in rapid traverse and the next G70 cycle block is read.

#### - Target figure

##### Check function

The following check can be made.

| Check   | Related parameter   |
|---|---|
| Checks that a block with the sequence number specified at address Q is contained in the program before cycle operation. | Enabled when bit 2 (QSR) of parameter No. 5102 is set to 1. |

#### - Storing P and Q blocks

When rough cutting is executed by G71, G72, or G73, up to three memory addresses of P and Q blocks are stored. By this, the blocks indicated by P and Q are immediately found at execution of G70 without searching memory from the beginning for them. After some G71, G72, and G73 rough cutting cycles are executed, finishing cycles can be performed by G70 at a time. At this time, for the fourth and subsequent rough cutting cycles, the cycle time is longer because memory is searched for P and Q blocks.

### Example

G71 P100 Q200 ...;

N100 ...;

...;

...;

N200 ...;

G71 P300 Q400 ...;

N300 ...;

...;

...;

N400 ...;

...;

...;

G70 P100 Q200 ; (Executed without a search for the first to third cycles)

G70 P300 Q400 ; (Executed after a search for the fourth and subsequent cycles)



**NOTE**

The memory addresses of P and Q blocks stored during rough cutting cycles by G71, G72, and G73 are erased after execution of G70.

All stored memory addresses of P and Q blocks are also erased by a reset.

**- Return to the cycle start point**

In a finishing cycle, after the tool cuts the workpiece to the end point of the target figure, it returns to the cycle start point in rapid traverse.

**NOTE**

The tool returns to the cycle start point always in the nonlinear positioning mode regardless of the setting of bit 1 (LRP) of parameter No. 1401.

Before executing a finishing cycle for a target figure with a pocket cut by G71 or G72, check that the tool does not interfere with the workpiece when returning from the end point of the target figure to the cycle start point.

**- Tool nose radius compensation**

When using tool nose radius compensation, specify a tool nose radius compensation command (G41 or G42) before a multiple repetitive canned cycle command (G70) and specify the cancel command (G40) after the multiple repetitive canned cycle command (G70).

Program example

G42;.....Specify this command before a multiple repetitive canned cycle command.

G70P10Q20;

G40;.....Specify this command after a multiple repetitive canned cycle command.

Like G71, this cycle operation is performed according to the figure determined by the tool nose radius compensation path when the offset vector is 0 at start point A and start-up is performed in a block between path A-A'.

**Example**

**Stock removal in facing (G72)**

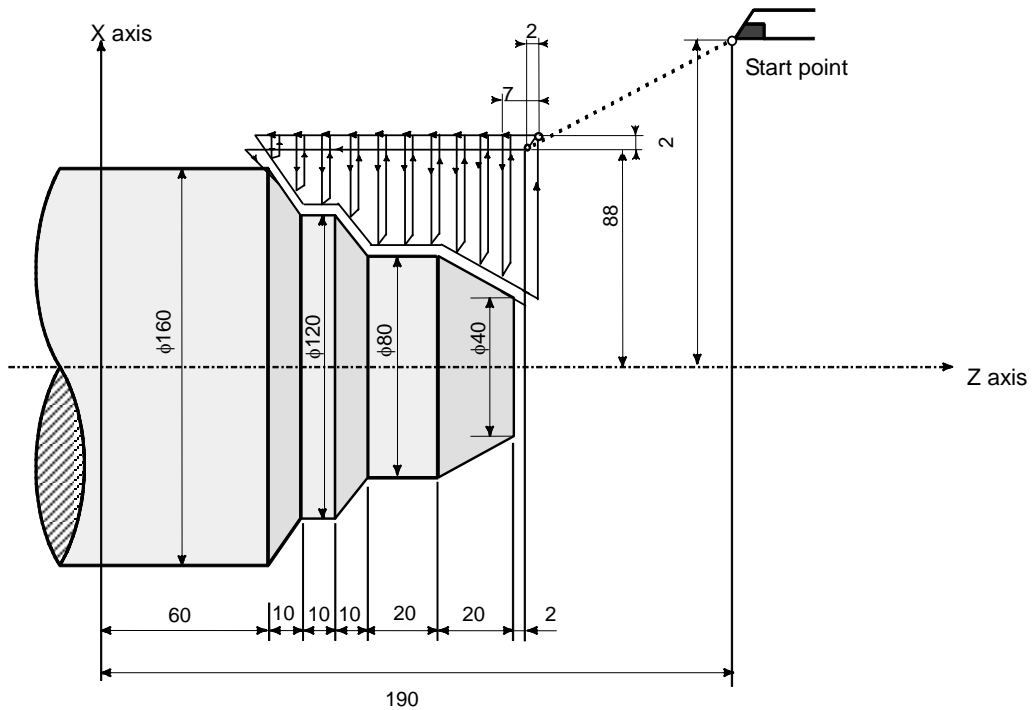

(Diameter designation for X axis, metric input)

```

N010 G50 X220.0 Z190.0 ;
N011 G00 X176.0 Z132.0 ;
N012 G72 W7.0 R1.0 ;
N013 G72 P014 Q019 U4.0 W2.0 F0.3 S550 ;
N014 G00 Z56.0 S700 ;
N015 G01 X120.0 W14.0 F0.15 ;
N016 W10.0 ;
N017 X80.0 W10.0 ;
N018 W20.0 ;
N019 X36.0 W22.0 ;
N020 G70 P014 Q019 ;
    
```

Escaping amount: 1.0

Finishing allowance (4.0 in diameter in the X direction, 2.0 in the Z direction)

**Pattern repeating (G73)**

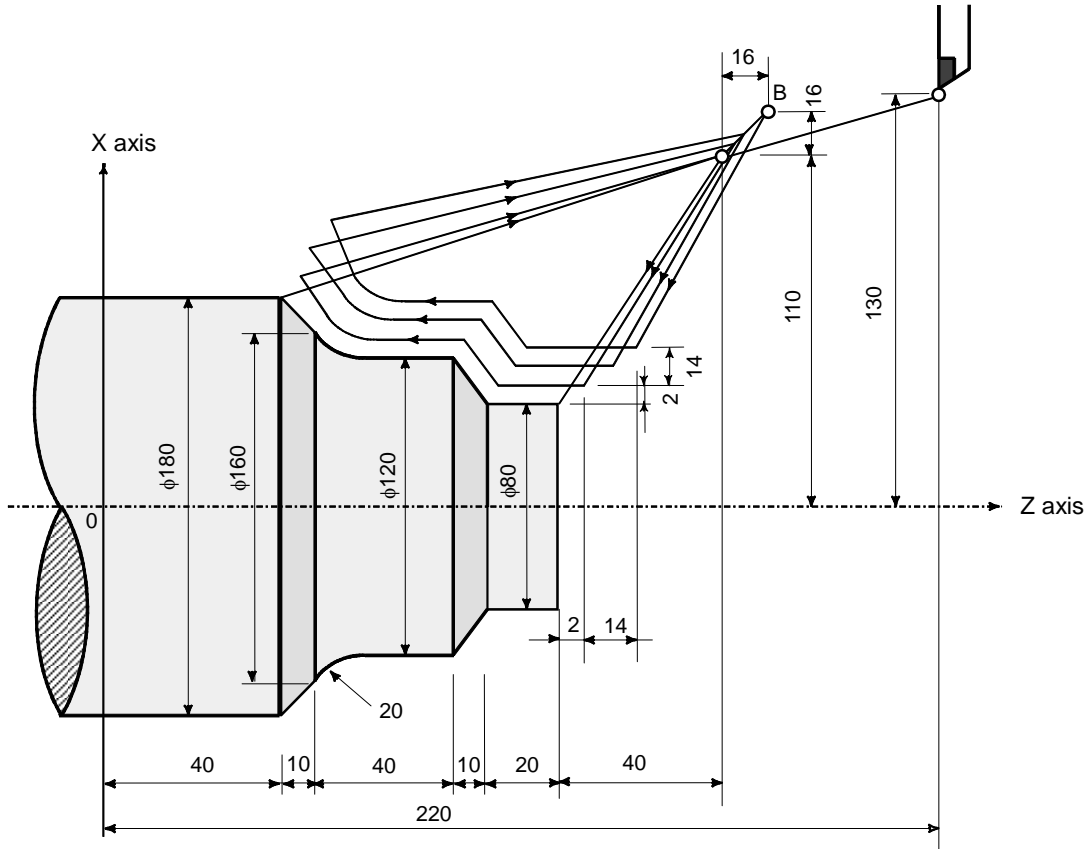

(Diameter designation, metric input)

```

N010 G50 X260.0 Z220.0 ;
N011 G00 X220.0 Z160.0 ;
N012 G73 U14.0 W14.0 R3 ;
N013 G73 P014 Q019 U4.0 W2.0 F0.3 S0180 ;
N014 G00 X80.0 W-40.0 ;
N015 G01 W-20.0 F0.15 S0600 ;
N016 X120.0 W-10.0 ;
N017 W-20.0 S0400 ;
N018 G02 X160.0 W-20.0 R20.0 ;
N019 G01 X180.0 W-10.0 S0280 ;
N020 G70 P014 Q019 ;
    
```

## 4.2.5 End Face Peck Drilling Cycle (G74)

This cycle enables chip breaking in outer diameter cutting. If the second axis on the plane (X-axis (U-axis) for the ZX plane) and address P are omitted, operation is performed only along the first axis on the plane (Z-axis for the ZX plane), that is, a peck drilling cycle is performed.

### Format

**G74R (e) ;**

**G74X(U)\_ Z(W)\_ P( $\Delta$ i) Q( $\Delta$ k) R( $\Delta$ d) F (f) ;**

e : Return amount

This designation is modal and is not changed until the other value is designated. Also this value can be specified by the parameter No. 5139, and the parameter is changed by the program command.

X\_,Z\_ : Coordinate of the second axis on the plane (X-axis for the ZX plane) at point B and  
Coordinate of the first axis on the plane (Z-axis for the ZX plane) at point C

U\_,W\_ : Travel distance along the second axis on the plane (U for the ZX plane) from point A  
to B  
Travel distance along the first axis on the plane (W for the ZX plane) from point A to  
C

(When G code system A is used. In other cases, X\_,Z\_ is used for specification.)

$\Delta$ i : Travel distance in the direction of the second axis on the plane (X-axis for the ZX  
plane)

$\Delta$ k : Depth of cut in the direction of the first axis on the plane (Z-axis for the ZX plane)

$\Delta$ d : Relief amount of the tool at the cutting bottom

f : Feedrate

|            | Unit  | Diameter/radius<br>programming | Sign         | Decimal point<br>input |
|------------|---|--------------------------------|--------------|------------------------|
| e          | Depends on the increment system for the reference axis. | Radius programming             | Not required | Allowed                |
| $\Delta$ i | Depends on the increment system for the reference axis. | Radius programming             | Not required | Not allowed            |
| $\Delta$ k | Depends on the increment system for the reference axis. | Radius programming             | Not required | Not allowed            |
| $\Delta$ d | Depends on the increment system for the reference axis. | Radius programming             | NOTE         | Allowed                |

### NOTE

Normally, specify a positive value for  $\Delta$ d. When X (U) and  $\Delta$ i are omitted, specify a value with the sign indicating the direction in which the tool is to escape.

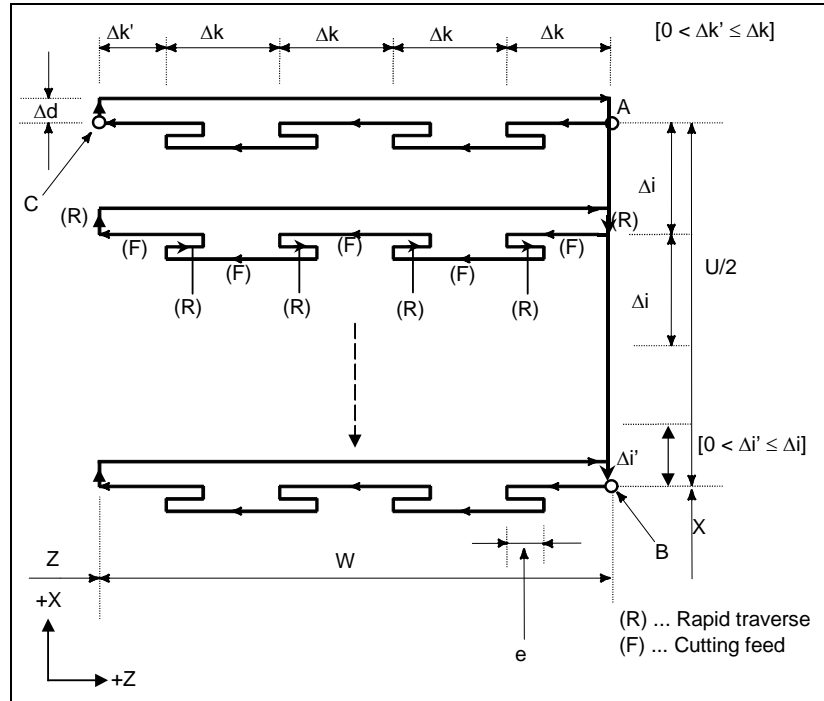

Fig. 4.2.5 (a) Cutting path in end face peak drilling cycle

**Explanation****- Operations**

A cycle operation of cutting by  $\Delta k$  and return by  $e$  is repeated.

When cutting reaches point C, the tool escapes by  $\Delta d$ . Then, the tool returns in rapid traverse, moves to the direction of point B by  $\Delta i$ , and performs cutting again.

**NOTE**

- 1 While both  $e$  and  $\Delta d$  are specified by the same address, the meanings of them are determined by specifying the X, Y, or Z axis. When the axis is specified,  $\Delta d$  is used.
- 2 The cycle machining is performed by G74 command with specifying the axis.

**- Tool nose radius compensation**

Tool nose radius compensation cannot be applied.

## 4.2.6 Outer Diameter / Internal Diameter Drilling Cycle (G75)

This cycle is equivalent to G74 except that the second axis on the plane (X-axis for the ZX plane) changes places with the first axis on the plane (Z-axis for the ZX plane). This cycle enables chip breaking in end facing. It also enables grooving during outer diameter cutting and cutting off (when the Z-axis (W-axis) and Q are omitted for the first axis on the plane).

### Format

**G75R (e) ;**

**G75X(U)\_ Z(W)\_ P( $\Delta$ i) Q( $\Delta$ k) R( $\Delta$ d) F (f) ;**

e : Return amount

This designation is modal and is not changed until the other value is designated. Also this value can be specified by the parameter No. 5139, and the parameter is changed by the program command.

X\_, Z\_ : Coordinate of the second axis on the plane (X-axis for the ZX plane) at point B and Coordinate of the first axis on the plane (Z-axis for the ZX plane) at point C

U\_, W\_ : Travel distance along the second axis on the plane (U for the ZX plane) from point A to B  
Travel distance along the first axis on the plane (W for the ZX plane) from point A to C

(When G code system A is used. In other cases, X\_,Z\_ is used for specification.)

$\Delta$ i : Depth of cut in the direction of the second axis on the plane (X-axis for the ZX plane)

$\Delta$ k : Travel distance in the direction of the first axis on the plane (Z-axis for the ZX plane)

$\Delta$ d : Relief amount of the tool at the cutting bottom

f : Feedrate

|            | Unit  | Diameter/radius programming | Sign         | Decimal point input |
|------------|---|-----------------------------|--------------|---------------------|
| e          | Depends on the increment system for the reference axis. | Radius programming          | Not required | Allowed             |
| $\Delta$ i | Depends on the increment system for the reference axis. | Radius programming          | Not required | Not allowed         |
| $\Delta$ k | Depends on the increment system for the reference axis. | Radius programming          | Not required | Not allowed         |
| $\Delta$ d | Depends on the increment system for the reference axis. | Radius programming          | NOTE         | Allowed             |

### NOTE

Normally, specify a positive value for  $\Delta$ d. When Z (W) and  $\Delta$ k are omitted, specify a value with the sign indicating the direction in which the tool is to escape.

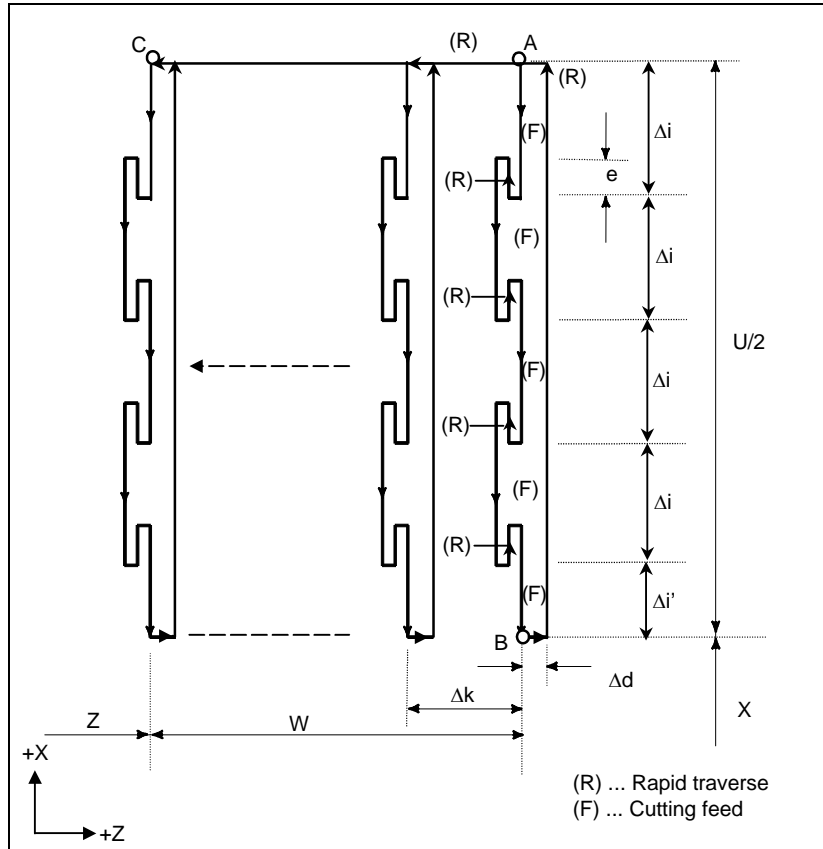

Fig. 4.2.6 (b) Outer diameter/internal diameter drilling cycle

**Explanation**

**- Operations**

A cycle operation of cutting by  $\Delta i$  and return by  $e$  is repeated.

When cutting reaches point B, the tool escapes by  $\Delta d$ . Then, the tool returns in rapid traverse, moves to the direction of point C by  $\Delta k$ , and performs cutting again.

Both G74 and G75 are used for grooving and drilling, and permit the tool to relief automatically. Four symmetrical patterns are considered, respectively.

**- Tool nose radius compensation**

Tool nose radius compensation cannot be applied.

## 4.2.7 Multiple Threading Cycle (G76)

This threading cycle performs one edge cutting by the constant amount of cut.

### Format

**G76 P(m) (r) (a) Q( $\Delta$ admin) R(d) ;**

**G76 X(U)\_ Z(W)\_ R(i) P(k) Q( $\Delta$ d) F (L) ;**

**m** : Repetitive count in finishing (1 to 99)

This value can be specified by the parameter No. 5142, and the parameter is changed by the program command.

**r** : Chamfering amount (0 to 99)

When the thread lead is expressed by L, the value of L can be set from 0.0L to 9.9L in 0.1L increment (2-digit number). This value can be specified by the parameter No. 5130, and the parameter is changed by the program command.

**a** : Angle of tool nose

One of six kinds of angle, 80°, 60°, 55°, 30°, 29°, and 0°, can be selected, and specified by 2-digit number. This value can be specified by the parameter No. 5143, and the parameter is changed by the program command.

m, r, and a are specified by address P at the same time.

(Example) When m=2, r=1.2L, a=60°, specify as shown below (L is lead of thread).

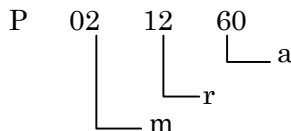

$\Delta$ admin : Minimum cutting depth

When the cutting depth of one cycle operation becomes smaller than this limit, the cutting depth is clamped at this value. This value can be specified by parameter No. 5140, and the parameter is changed by the program command.

**d** : Finishing allowance

This value can be specified by parameter No. 5141, and the parameter is changed by the program command.

**X\_, Z\_** : Coordinates of the cutting end point (point D in the Fig. 4.2.7 (a)) in the direction of the length

**U\_, W\_** : Travel distance to the cutting end point (point D in the Fig. 4.2.7 (a)) in the direction of the length

(When G code system A is used. In other cases, X\_,Z\_ is used for specification.)

**i** : Taper amount

If i = 0, ordinary straight threading can be made.

**k** : Height of thread

$\Delta$ d : Depth of cut in 1st cut

**L** : Lead of thread

|                | Unit  | Diameter/radius programming | Sign         | Decimal point input |
|----------------|---|-----------------------------|--------------|---------------------|
| $\Delta$ admin | Depends on the increment system for the reference axis. | Radius programming          | Not required | Not allowed         |
| d              | Depends on the increment system for the reference axis. | Radius programming          | Not required | Allowed             |
| i              | Depends on the increment system for the reference axis. | Radius programming          | Required     | Allowed             |
| k              | Depends on the increment system for the reference axis. | Radius programming          | Not required | Not allowed         |



|            | Unit  | Diameter/radius programming | Sign         | Decimal point input |
|------------|---|-----------------------------|--------------|---------------------|
| $\Delta d$ | Depends on the increment system for the reference axis. | Radius programming          | Not required | Not allowed         |

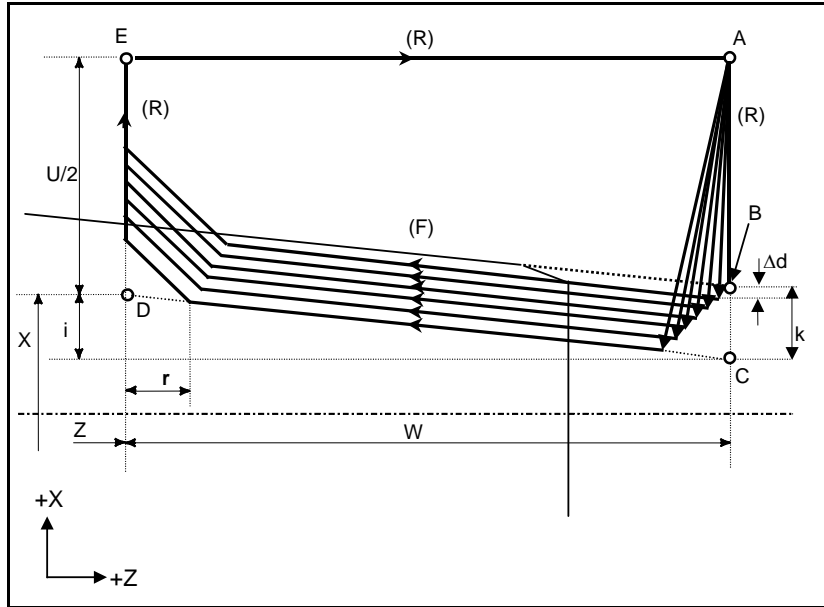

Fig. 4.2.7 (a) Cutting path in multiple threading cycle

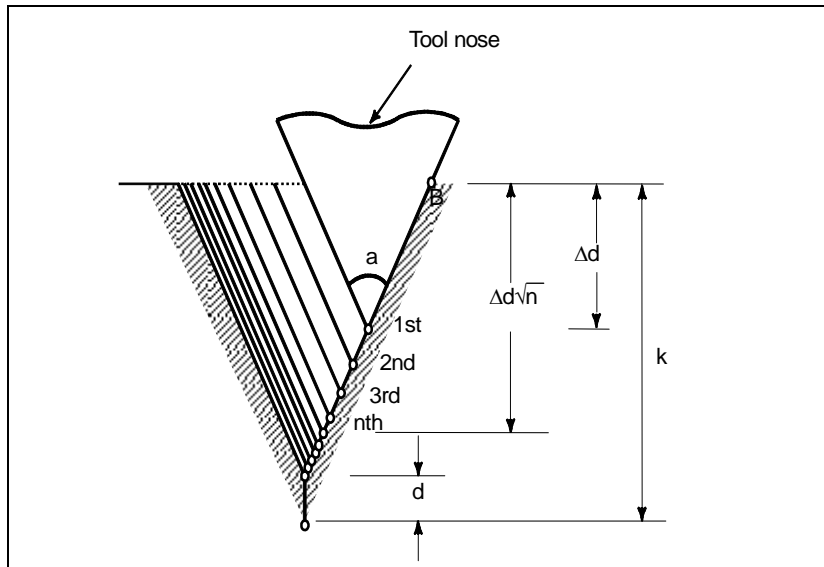

Fig. 4.2.7 (b) Detail of cutting

**- Repetitive count in finishing**

The last finishing cycle (cycle in which the finishing allowance is removed by cutting) is repeated.

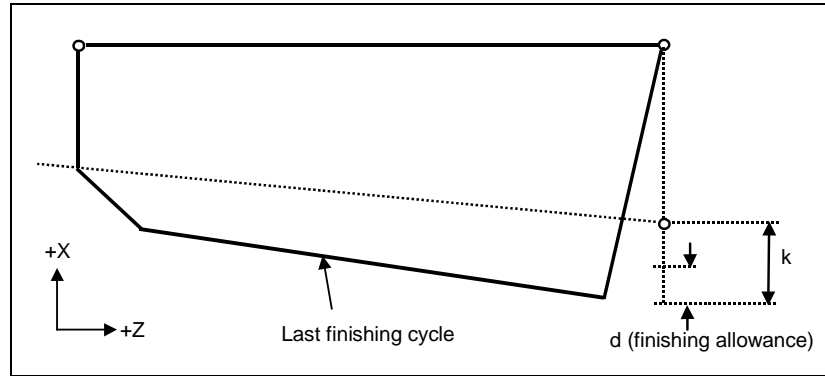

Fig. 4.2.7 (c)

### Explanation

#### - Operations

This cycle performs threading so that the length of the lead only between C and D is made as specified in the F code. In other sections, the tool moves in rapid traverse.

The time constant for acceleration/deceleration after interpolation and FL feedrate for thread chamfering and the feedrate for retraction after chamfering are the same as for thread chamfering with G92 (canned cycle).

#### NOTE

- 1 The meanings of the data specified by address P, Q, and R determined by the presence of X (U) and Z (W).
- 2 The cycle machining is performed by G76 command with X (U) and Z (W) specification.
- 3 The values specified at addresses P, Q, and R are modal and are not changed until another value is specified.
- 4 Specify a value smaller than the height of thread as the finishing allowance. ( $d < k$ )

#### ⚠ CAUTION

Notes on threading are the same as those on G32 threading. For feed hold in a threading cycle, however, see "Feed hold in a threading cycle" described below.

#### - Relationship between the sign of the taper amount and tool path

The signs of incremental dimensions for the cycle shown in Fig. 4.2.7 (a) are as follows:

Cutting end point in the direction of the length for U and W:

Minus (determined according to the directions of paths A-C and C-D)

Taper amount (i): Minus (determined according to the direction of path A-C)

Height of thread (k): Plus (always specified with a plus sign)

Depth of cut in the first cut ( $\Delta d$ ): Plus (always specified with a plus sign)

The four patterns shown in the Table 4.2.7 (a) are considered corresponding to the sign of each address. A female thread can also be machined.

Table 4.2.7 (a)

| Outer diameter machining   | Internal diameter machining  |
|--|--|
| <p>1. <math>U &lt; 0, W &lt; 0, i &lt; 0</math></p>                                    | <p>2. <math>U &gt; 0, W &lt; 0, i &gt; 0</math></p>                                    |
| <p>3. <math>U &lt; 0, W &lt; 0, i &gt; 0</math><br/>at <math> i  \leq  U/2 </math></p> | <p>4. <math>U &gt; 0, W &lt; 0, i &lt; 0</math><br/>at <math> i  \leq  U/2 </math></p> |

#### - Acceleration/deceleration after interpolation for threading

Acceleration/deceleration after interpolation for threading is acceleration/deceleration of exponential interpolation type. By setting bit 5 (THLx) of parameter No. 1610, the same acceleration/deceleration as for cutting feed can be selected. (The settings of bits 1 (CTBx) and 0 (CTLx) of parameter No. 1610 are followed.) However, as a time constant and FL feedrate, the settings of parameter No. 1626 and No. 1627 for the threading cycle are used.

#### - Time constant and FL feedrate for threading

The time constant for acceleration/deceleration after interpolation for threading specified in parameter No. 1626 and the FL feedrate specified in parameter No. 1627 are used.

The FL feedrate is valid only for exponential acceleration/deceleration after interpolation.

#### - Thread chamfering

Thread chamfering can be performed in this threading cycle. A signal from the machine tool initiates thread chamfering.

The maximum amount of thread chamfering ( $r$ ) that can be specified in the command is 99 (9.9L). The amount can be specified in a range from 0.1L to 12.7L in 0.1L increments in parameter No. 5130.

A thread chamfering angle between 1 to 89 degrees can be specified in parameter No. 5131. When a value of 0 is specified in the parameter, an angle of 45 degrees is assumed.

For thread chamfering, the same type of acceleration/deceleration after interpolation, time constant for acceleration/deceleration after interpolation, and FL feedrate as for threading are used.

#### NOTE

Common parameters for specifying the amount and angle of thread chamfering are used for this cycle and G92 threading cycle.

**- Retraction after chamfering**

The Table 4.2.7 (b) lists the feedrate, type of acceleration/deceleration after interpolation, and time constant of retraction after chamfering.

**Table 4.2.7 (b)**

| Bit 0 (CFR) of parameter No. 1611 | Parameter No. 1466 | Description  |
|-----------------------------------|--------------------|--|
| 0                                 | Other than 0       | Uses the type of acceleration/deceleration after interpolation for threading, time constant for threading (parameter No. 1626), FL feedrate (parameter No. 1627), and retraction feedrate specified in parameter No. 1466.   |
| 0                                 | 0                  | Uses the type of acceleration/deceleration after interpolation for threading, time constant for threading (parameter No. 1626), FL feedrate (parameter No. 1627), and rapid traverse rate specified in parameter No. 1420.   |
| 1                                 |                    | Before retraction a check is made to see that the specified feedrate has become 0 (delay in acceleration/deceleration is 0), and the type of acceleration/deceleration after interpolation for rapid traverse is used together with the rapid traverse time constant and the rapid traverse rate (parameter No. 1420). |

By setting bit 4 (ROC) of parameter No. 1403 to 1, rapid traverse override can be disabled for the feedrate of retraction after chamfering.

**NOTE**

During retraction, the machine does not stop with an override of 0% for the cutting feedrate regardless of the setting of bit 4 (RF0) of parameter No. 1401.

**- Shifting the start angle**

The threading start angle cannot be shifted.

However, if the Series 10/11 format is used, the threading start angle can be shifted.

Please refer to the "MEMORY OPERATION USING Series 10/11 FORMAT".

**- Feed hold in a threading cycle (threading cycle retract)**

When feed hold is applied during threading in a combined threading cycle (G76), the tool quickly retracts in the same way as for the last chamfering in a threading cycle and returns to the start point in the current cycle.

When cycle start is triggered, the multiple threading cycle resumes.

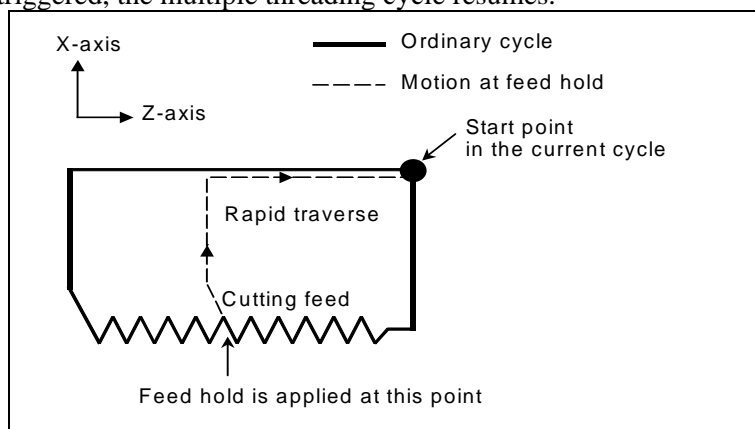

**Fig. 4.2.7 (d)**

The angle of chamfering during retraction is the same as that of chamfering at the end point.

**CAUTION**

Another feed hold cannot be performed during retraction.

- **Inch threading**

Inch threading specified with address E is not allowed.

- **Tool nose radius compensation**

Tool nose radius compensation cannot be applied.

### Example

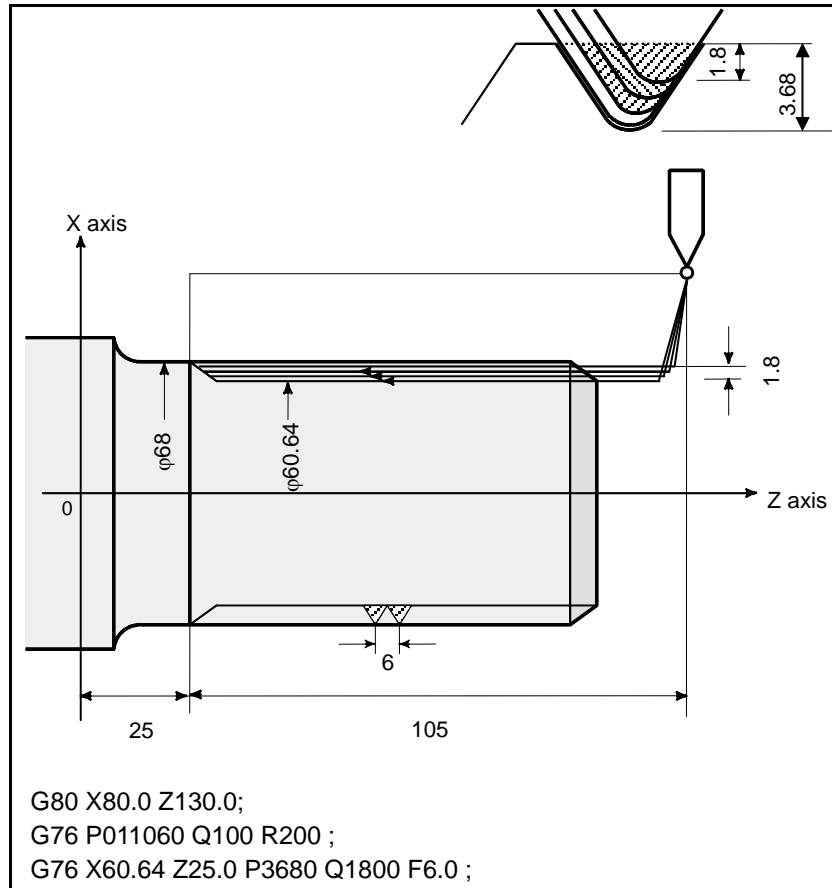

Fig. 4.2.7 (e)

## 4.2.8 Restrictions on Multiple Repetitive Canned Cycle (G70-G76)

### Programmed commands

- **Program memory**

Programs using G70, G71, G72, or G73 must be stored in the program memory. The use of the mode in which programs stored in the program memory are called for operation enables these programs to be executed in other than the MEM mode. Programs using G74, G75, or G76 need not be stored in the program memory.

- **Blocks in which data related to a multiple repetitive canned cycle is specified**

The addresses P, Q, X, Z, U, W, and R should be specified correctly for each block.

In a block in which G70, G71, G72, or G73 is specified, the following functions cannot be specified:

- Custom macro calls (simple call, modal call, and subprogram call)

**- Blocks in which data related to a target figure is specified**

In the block which is specified by address P of a G71, G72 or G73, G00 or G01 code in group 01 should be commanded. If it is not commanded, alarm PS0065, "G00/G01 IS NOT IN THE FIRST BLOCK OF SHAPE PROGRAM" is generated.

In blocks with sequence numbers between those specified at P and Q in G70, G71, G72, and G73, the following commands can be specified:

(1) Dwell (G04)

(2) G00, G01, G02, and G03

When a circular interpolation command (G02, G03) is used, there must be no radius difference between the start point and end point of the arc. If there is a radius difference, the target finishing figure may not be recognized correctly, resulting in a cutting error such as excessive cutting.

(3) Custom macro branch and repeat command

The branch destination must be between the sequence numbers specified at P and Q, however.

High-speed branch specified by bits 1 and 4 of parameter No. 6000 is invalid. No custom macro call (simple, modal, or subprogram call) cannot be specified.

(4) Direct drawing dimension programming command and chamfering and corner R command

Direct drawing dimension programming and chamfering and corner R require multiple blocks to be specified. The block with the last sequence number specified at Q must not be an intermediate block of these specified blocks.

When G70, G71, G72, or G73 is executed, the sequence number specified by address P and Q should not be specified twice or more in the same program.

When #1 = 2500 is executed using a custom macro, 2500.000 is assigned to #1. In such a case, P#1 is equivalent to P2500.

**Relation with other functions**

**- Manual intervention**

After manual intervention is performed with the manual absolute on command before the execution of a multiple repetitive canned cycles (G70 to G76) or after the stop of the execution, when a cycle operation starts, the manual intervention amount is canceled even with an incremental cycle start command. When only the first plane axis is specified in G74 or only the second plane axis is specified in G74, however, the manual intervention amount is canceled only along the specified axis.

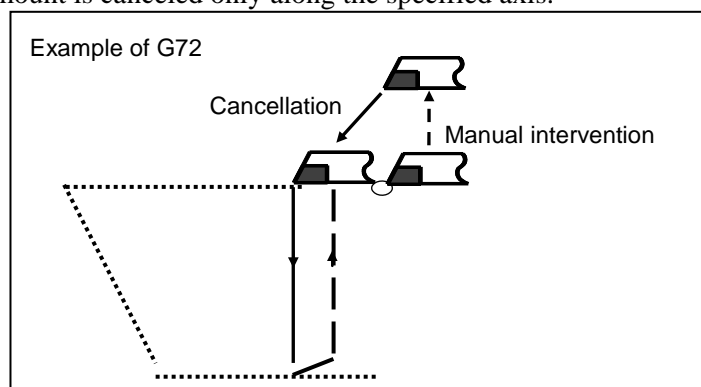

Fig. 4.2.8 (a)

**- Interruption type macro**

Any interruption type macro program cannot be executed during execution of a multiple repetitive canned cycle.

**- Program restart and tool retract and recover**

These functions cannot be executed in a block in a multiple repetitive canned cycle.

**- Axis name and second auxiliary functions**

Even if address U, V, or W is used as an axis name or second auxiliary function, data specified at address U, V, or W in a G71 to G73 block is assumed to be that for the multiple repetitive canned cycle.

**- Tool nose radius compensation**

When using tool nose radius compensation, specify a tool nose radius compensation command (G41, G42) before a multiple repetitive canned cycle command (G70, G71, G72, G73) and specify the cancel command (G40) outside the programs (from the block specified with P to the block specified with Q) specifying a target finishing figure. If tool nose radius compensation is specified in the program specifying a target finishing figure, alarm PS0325, "UNAVAILABLE COMMAND IS IN SHAPE PROGRAM", is issued.

**- Multi-spindle control**

When a spindle selection by address P of multi-spindle control or the command by the extended spindle name is used, S code cannot be specified at the block of multiple repetitive canned cycle command (G71-G73). (The alarm PS5305 "ILLEGAL SPINDLE NUMBER" is issued.)

In this case, instead of specifying S code at the block of multiple repetitive canned cycle command (G71-G73) is specified, specify S code before the multiple repetitive canned cycle command (G71-G73) block.

## 4.3 CANNED CYCLE FOR DRILLING

Canned cycles for drilling make it easier for the programmer to create programs. With a canned cycle, a frequently-used machining operation can be specified in a single block with a G function; without canned cycles, more than one block is required. In addition, the use of canned cycles can shorten the program to save memory.

Table 4.3 (a) lists canned cycles for drilling.

Table 4.3 (a) Canned cycles for drilling

| G code | Drilling axis | Hole machining operation    | Operation in the bottom hole position | Retraction operation | Applications         |
|--------|---------------|-----------------------------|---------------------------------------|----------------------|----------------------|
| G80    | -             | -                           | -                                     | -                    | Cancel               |
| G83    | Z axis        | Cutting feed / intermittent | Dwell                                 | Rapid traverse       | Front drilling cycle |
| G84    | Z axis        | Cutting feed                | Dwell → spindle CCW                   | Cutting feed         | Front tapping cycle  |
| G85    | Z axis        | Cutting feed                | Dwell                                 | Cutting feed         | Front boring cycle   |
| G87    | X axis        | Cutting feed / intermittent | Dwell                                 | Rapid traverse       | Side drilling cycle  |
| G88    | X axis        | Cutting feed                | Dwell → Spindle CCW                   | Cutting feed         | Side tapping cycle   |
| G89    | X axis        | Cutting feed                | Dwell                                 | Cutting feed         | Side boring cycle    |

### NOTE

When bit 4 (NCD) of parameter No.8137 is 0, this function can be used.

### Explanation

The canned cycle for drilling consists of the following six operation sequences.

- Operation 1 Positioning of X (Z) and C axis
- Operation 2 Rapid traverse up to point R level
- Operation 3 Hole machining
- Operation 4 Operation at the bottom of a hole
- Operation 5 Retraction to point R level
- Operation 6 Rapid traverse up to the initial level

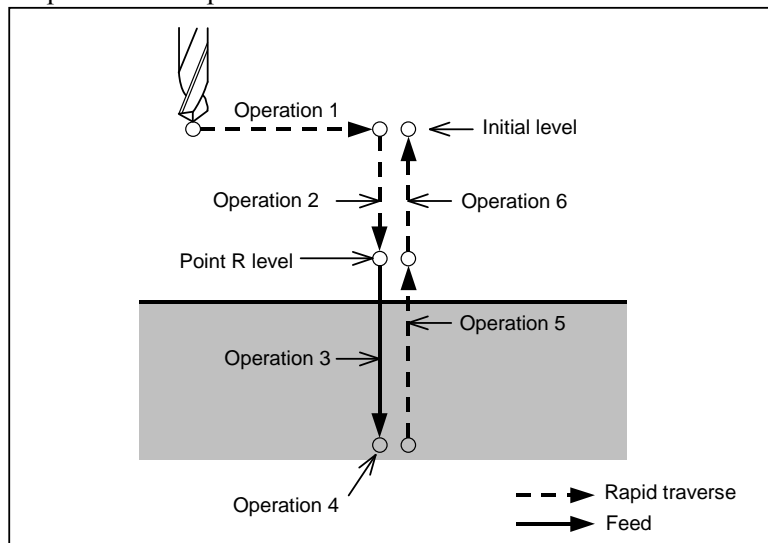

Fig. 4.3 (a) Operation sequence of canned cycle for drilling



**- Positioning axis and drilling axis**

The C-axis and X- or Z-axis are used as positioning axes. The X- or Z-axis, which is not used as a positioning axis, is used as a drilling axis. A drilling G code specifies positioning axes and a drilling axis as shown below.

Although canned cycles include tapping and boring cycles as well as drilling cycles, in this chapter, only the term drilling will be used to refer to operations implemented with canned cycles.

**Table 4.3 (b) Positioning axis and drilling axis**

| G code        | Positioning axis | Drilling axis |
|---------------|------------------|---------------|
| G83, G84, G85 | X axis, C axis   | Z axis        |
| G87, G88, G89 | Z axis, C axis   | X axis        |

G83 and G87, G84 and G88, and G85 and G89 have the same function respectively except for axes specified as positioning axes and a drilling axis.

**- Drilling mode**

G83 to G85/G87 to G89 are modal G codes and remain in effect until canceled. When in effect, the current state is the drilling mode.

Once drilling data is specified in the drilling mode, the data is retained until modified or canceled.

Specify all necessary drilling data at the beginning of canned cycles; when canned cycles are being performed, specify data modifications only.

The feedrate specified at F is retained also after the drilling cycle is canceled. When Q data is required, it must be specified in each block. Once specified, the M code used for C-axis clamp/unclamp functions as a modal code. It is canceled by specifying G80.

**- Return point level**

In G code system A, the tool returns to the initial level from the bottom of a hole. In G code system B or C, specifying G98 returns the tool to the initial level from the bottom of a hole and specifying G99 returns the tool to the point R level from the bottom of a hole.

The following illustrates how the tool moves when G98 or G99 is specified (Fig. 4.3 (b)). Generally, G99 is used for the first drilling operation and G98 is used for the last drilling operation.

The initial level does not change even when drilling is performed in the G99 mode.

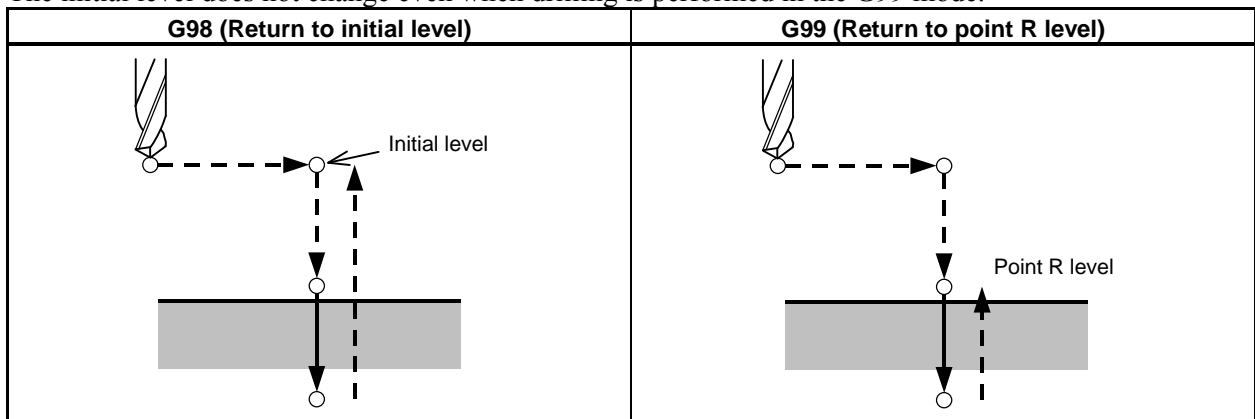

**Fig. 4.3 (b)**

**- Number of repeats**

To repeat drilling for equally-spaced holes, specify the number of repeats in K\_.

K is effective only within the block where it is specified.

Specify the first hole position in incremental programming.

If it is specified in absolute programming, drilling is repeated at the same position.

|                     |                                  |
|---------------------|----------------------------------|
| Number of repeats K | The maximum command value = 9999 |
|---------------------|----------------------------------|

When K0 is specified, drilling data is just stored without drilling being performed.

**NOTE**

For K, specify an integer of 0 or 1 to 9999.

**- M code used for C-axis clamp/unclamp**

When an M code specified in parameter No. 5110 for C-axis clamp/unclamp is coded in a program, the following operations occur.

- (1) The CNC issues the M code for C-axis clamp after the tool is positioned and while the tool is being fed in rapid traverse to the point-R level.
- (2) The CNC issues the M code for C-axis unclamp (the M code for C-axis clamp +1) after the tool retracts to the point-R level.
- (3) After the CNC issues the M code for C-axis unclamp, the tool dwells for the time specified in parameter No. 5111.

**- Cancel**



To cancel a canned cycle, use G80 or a group 01 G code.

Group 01 G codes (Example)

- G00 : Positioning (rapid traverse)
- G01 : Linear interpolation
- G02 : Circular interpolation (CW)
- G03 : Circular interpolation (CCW)

**- Symbols in figures**

Subsequent subsections explain the individual canned cycles. Figures in these explanations use the following symbols:

|   |  |
|---|--|
|  | Positioning (rapid traverse G00)   |
|  | Cutting feed (linear interpolation G01)  |
| P1  | Dwell specified in the program   |
| P2  | Dwell specified in parameter No.5111   |
| M $\alpha$  | Issuing the M code for C-axis clamp<br>(The value of $\alpha$ is specified with parameter No. 5110.) |
| M ( $\alpha + 1$ )  | Issuing the M code for C-axis unclamp  |

**⚠ CAUTION**

- 1 In each canned cycle, addresses R, Z, and X are handled as follows:  
   R\_ : Always handled as a radius.  
   Z\_ or X\_ : Depends on diameter/radius programming.
- 2 For the B or C G-code system, G90 or G91 can be used to select an incremental or absolute programming for hole position data (X, C or Z, C), the distance from point R to the bottom of the hole (Z or X), and the distance from the initial level to the point R level (R).
- 3 For canned cycles for drilling specified in the Series 10/11 format (by setting bit 1 (FCV) of parameter No. 0001 to 1 and bit 3 (F16) of parameter No. 5102 to 0), incremental programming is used for point R data when bit 6 (RAB) of parameter No. 5102 is set to 0.  
   When bit 6 (RAB) of parameter No. 5102 is set to 1, in G code system A, absolute programming is used, and in G code system B or C, absolute or incremental programming is used according to G90 or G91.  
   For canned cycles for drilling in the Series 0i-C format, incremental programming is used for point R data.

### 4.3.1 Front Drilling Cycle (G83)/Side Drilling Cycle (G87)

The peck drilling cycle or high-speed peck drilling cycle is used depending on the setting in RTR, bit 2 of parameter No. 5101. If depth of cut for each drilling is not specified, the normal drilling cycle is used. Without using parameter RTR, the high-speed peck drilling cycle can be specified with G83.5 or G87.5 and the peck drilling cycle can be specified with G83.6 or G87.6.

**- High-speed peck drilling cycle (G83, G87) (bit 2 (RTR) of parameter No. 5101 =0)**

This cycle performs high-speed peck drilling. The drill repeats the cycle of drilling at the cutting feedrate and retracting the specified retraction distance intermittently to the bottom of a hole. The drill draws cutting chips out of the hole when it retracts.

**Format**

**G83 X(U)\_ C(H)\_ Z(W)\_ R\_ P\_ Q\_ F\_ K\_ M\_ ;**

or

**G87 Z(W)\_ C(H)\_ X(U)\_ R\_ P\_ Q\_ F\_ K\_ M\_ ;**

X\_ C\_ or Z\_ C\_ : Hole position data

Z\_ or X\_ : The distance from point R to the bottom of the hole

R\_ : The distance from the initial level to point R level

P\_ : Dwell time at the bottom of a hole

Q\_ : Depth of cut for each cutting feed

F\_ : Cutting feedrate

K\_ : Number of repeats (When it is needed)

M\_ : M code for C-axis clamp (When it is needed.)

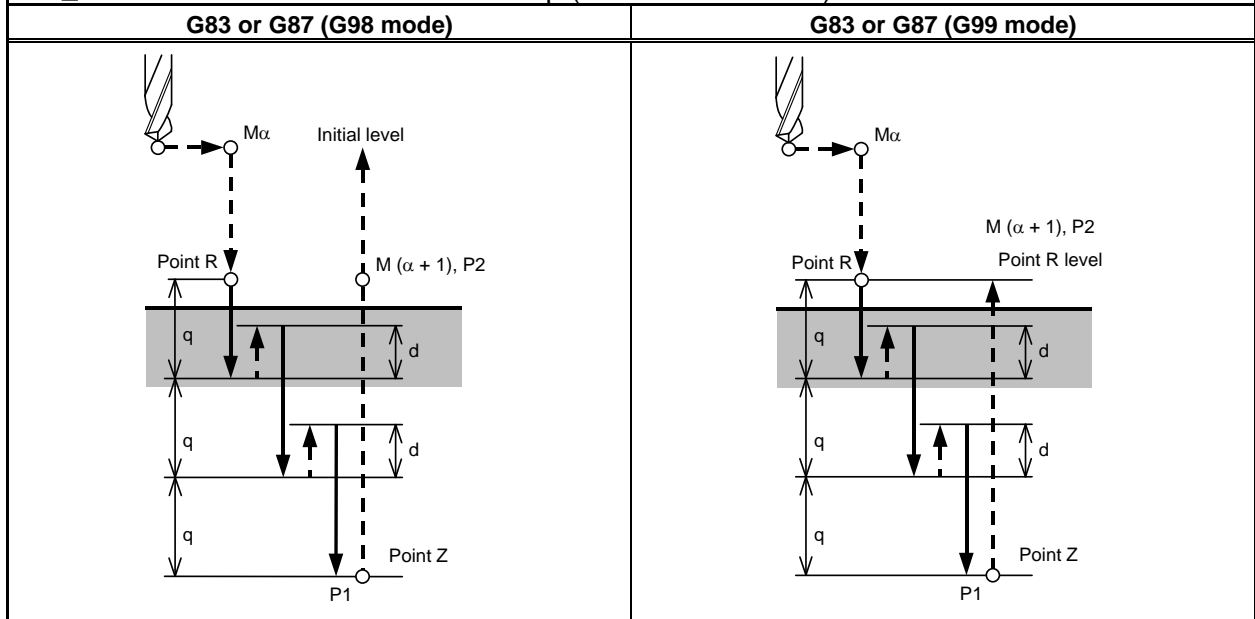

M $\alpha$  : M code for C-axis clamp

M( $\alpha + 1$ ): M code for C-axis unclamp

P1 : Dwell specified in the program

P2 : Dwell specified in parameter No. 5111

d : Retraction distance specified in parameter No. 5114

- Peck drilling cycle (G83, G87) (bit 2 (RTR) of parameter No. 5101 =1)

**Format**

**G83 X(U)\_ C(H)\_ Z(W)\_ R\_ P\_ Q\_ F\_ K\_ M\_ ;**

or

**G87 Z(W)\_ C(H)\_ X(U)\_ R\_ P\_ Q\_ F\_ K\_ M\_ ;**

X\_ C\_ or Z\_ C\_ : Hole position data

Z\_ or X\_ : The distance from point R to the bottom of the hole

R\_ : The distance from the initial level to point R level

P\_ : Dwell time at the bottom of a hole

Q\_ : Depth of cut for each cutting feed

F\_ : Cutting feedrate

K\_ : Number of repeats (When it is needed.)

M\_ : M code for C-axis clamp (When it is needed.)

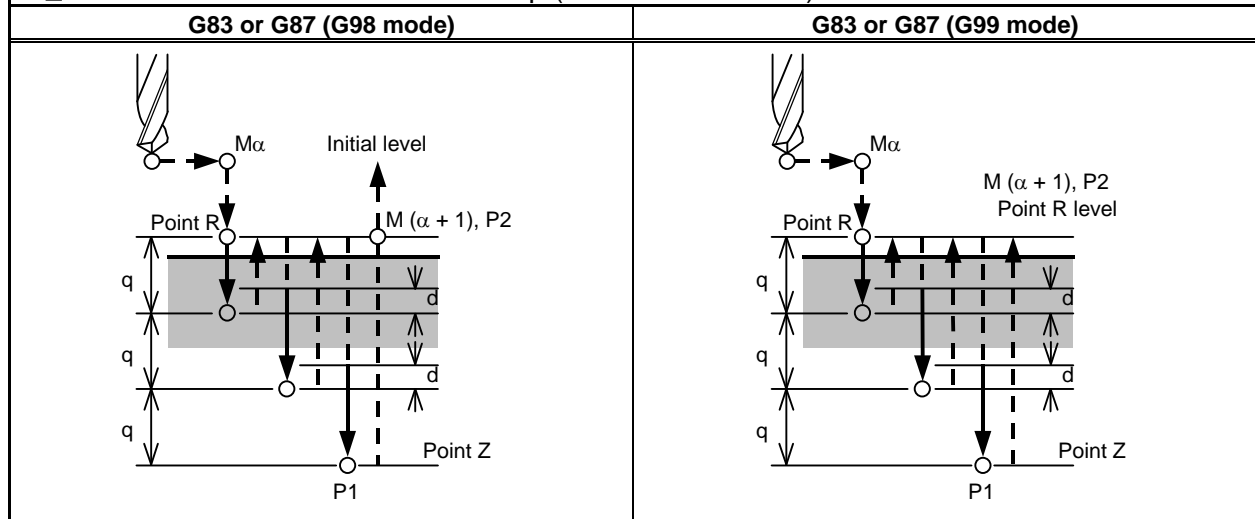

$M\alpha$  : M code for C-axis clamp

$M(\alpha + 1)$  : M code for C-axis unclamp

P1 : Dwell specified in the program

P2 : Dwell specified in parameter No. 5111

d : Retraction distance specified in parameter No. 5115

**Example**

|                                   |  |
|-----------------------------------|--|
| M51 ;                             | Setting C-axis index mode ON                             |
| M3 S2000 ;                        | Rotating the drill                                       |
| G00 X50.0 C0.0 ;                  | Positioning the drill along the X- and C-axes            |
| G83 Z-40.0 R-5.0 Q5000 F5.0 M31 ; | Drilling hole 1  |
| C90.0 Q5000 M31 ;                 | Drilling hole 2  |
| C180.0 Q5000 M31 ;                | Drilling hole 3  |
| C270.0 Q5000 M31 ;                | Drilling hole 4  |
| G80 M05 ;                         | Canceling the drilling cycle and stopping drill rotation |
| M50 ;                             | Setting C-axis index mode off                            |

**NOTE**

If the depth of cut for each cutting feed (Q) is not commanded, normal drilling is performed. (See the description of the drilling cycle.)

- **Drilling cycle (G83 or G87)**

If depth of cut (Q) is not specified for each drilling, the normal drilling cycle is used. The tool is then retracted from the bottom of the hole in rapid traverse.

**Format**

**G83 X(U)\_ C(H)\_ Z(W)\_ R\_ P\_ F\_ K\_ M\_ ;**

or

**G87 Z(W)\_ C(H)\_ X(U)\_ R\_ P\_ F\_ K\_ M\_ ;**

X\_ C\_ or Z\_ C\_ : Hole position data

Z\_ or X\_ : The distance from point R to the bottom of the hole

R\_ : The distance from the initial level to point R level

P\_ : Dwell time at the bottom of a hole

F\_ : Cutting feedrate

K\_ : Number of repeats (When it is needed.)

M\_ : M code for C-axis clamp (When it is needed.)

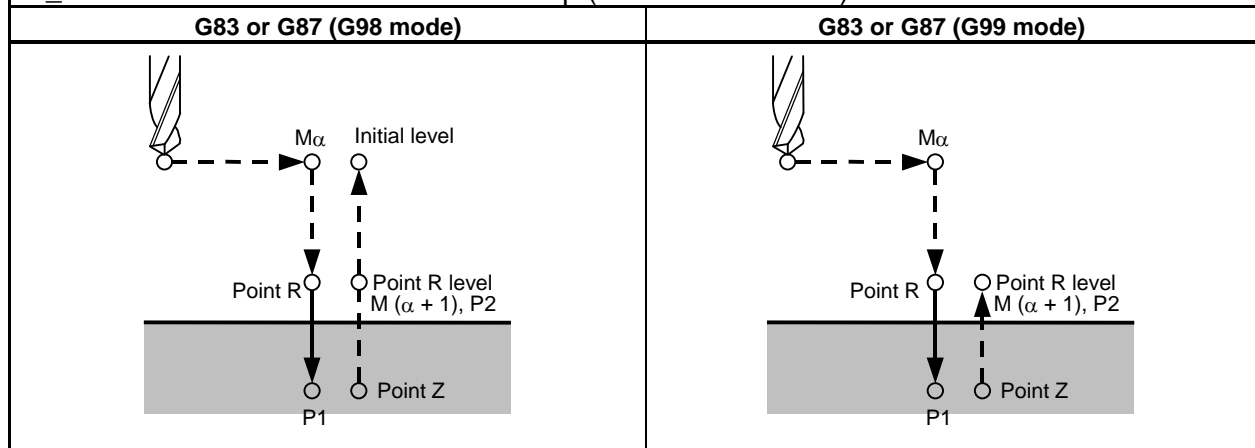

$M\alpha$  : M code for C-axis clamp

$M(\alpha + 1)$  : M code for C-axis unclamp

P1 : Dwell specified in the program

P2 : Dwell specified in parameter No. 5111

**Example**

|                                  |  |
|----------------------------------|--|
| M51 ;                            | Setting C-axis index mode ON                             |
| M3 S2000 ;                       | Rotating the drill                                       |
| G00 X50.0 C0.0 ;                 | Positioning the drill along the X- and C-axes            |
| G83 Z-40.0 R-5.0 P500 F5.0 M31 ; | Drilling hole 1  |
| C90.0 M31 ;                      | Drilling hole 2  |
| C180.0 M31 ;                     | Drilling hole 3  |
| C270.0 M31 ;                     | Drilling hole 4  |
| G80 M05 ;                        | Canceling the drilling cycle and stopping drill rotation |
| M50 ;                            | Setting C-axis index mode off                            |

## 4.3.2 Front Tapping Cycle (G84) / Side Tapping Cycle (G88)

This cycle performs tapping.

In this tapping cycle, when the bottom of the hole has been reached, the spindle is rotated in the reverse direction.

### Format

**G84 X(U)\_ C(H)\_ Z(W)\_ R\_ P\_ F\_ K\_ M\_ ;**

or

**G88 Z(W)\_ C(H)\_ X(U)\_ R\_ P\_ F\_ K\_ M\_ ;**

X\_ C\_ or Z\_ C\_ : Hole position data

Z\_ or X\_ : The distance from point R to the bottom of the hole

R\_ : The distance from the initial level to point R level

P\_ : Dwell time at the bottom of a hole

F\_ : Cutting feedrate

K\_ : Number of repeats (When it is needed.)

M\_ : M code for C-axis clamp (when it is needed.)

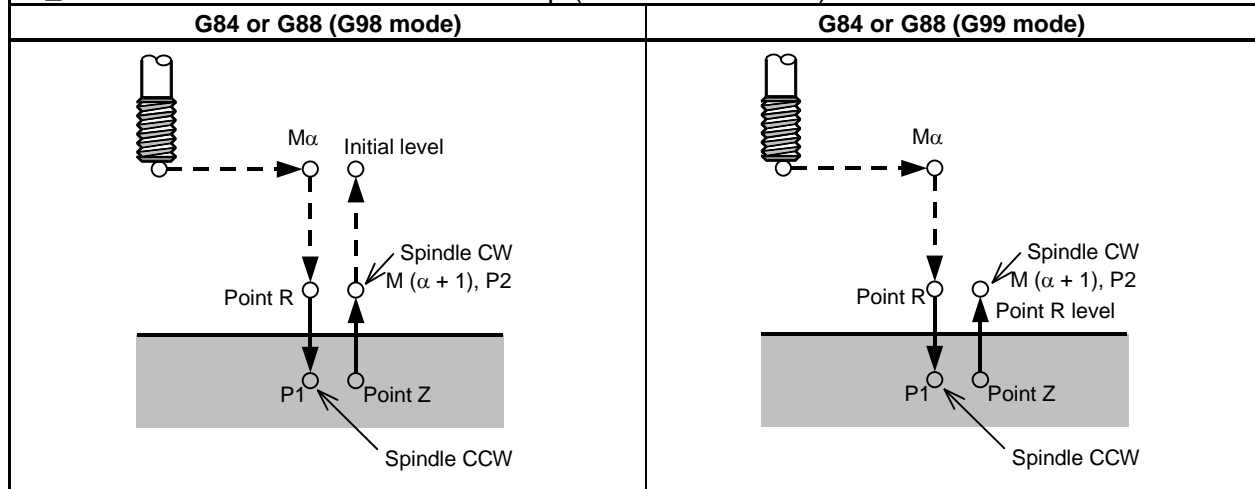

$M\alpha$  : M code for C-axis clamp

$M(\alpha + 1)$  : M code for C-axis unclamp

P1 : Dwell specified in the program

P2 : Dwell specified in parameter No. 5111

### Explanation

Tapping is performed by rotating the spindle clockwise. When the bottom of the hole has been reached, the spindle is rotated in the reverse direction for retraction. This operation creates threads.

Feedrate overrides are ignored during tapping. A feed hold does not stop the machine until the return operation is completed.

#### NOTE

Bit 3 (M5T) of parameter No. 5105 specifies whether the spindle stop command (M05) is issued before the direction in which the spindle rotates is specified with M03 or M04. For details, refer to the operator's manual created by the machine tool builder.

#### - Q command

After setting bit 6 (PCT) of parameter No. 5104 to 1, add address Q to the ordinary tapping cycle command format and specify the depth of cut for each tapping.

In the peck tapping cycle, the tool is retracted to point R for each tapping. In the high-speed peck tapping cycle, the tool is retracted by the retraction distance specified for parameter No. 5213 in advance. Which operation is to be performed can be selected by setting bit 5 (PCP) of parameter No. 5200.

### Operation

First, ordinary tapping cycle operation is explained as basic operation.

Before specifying a tapping cycle, rotate the spindle using a miscellaneous function.

1. When a command to position the tool to a hole position, positioning is performed.
2. When point R is specified, positioning to point R is performed.
3. Tapping is performed to the bottom of the hole in cutting feed.
4. When a dwell time (P) is specified, the tool dwells.
5. Miscellaneous function M05 (spindle stop) is output and the machine enters the FIN wait state.
6. When FIN is returned, miscellaneous function M04 (reverse spindle rotation) is output and the machine enters the FIN wait state.
7. When FIN is returned, the tap is removed until point R is reached in cutting feed.
8. When a dwell time (P) is specified, the tool dwells.
9. Miscellaneous function M05 (spindle stop) is output and the machine enters the FIN wait state.
10. When FIN is returned, miscellaneous function M03 (forward spindle rotation) is output, and the machine enters the FIN wait state.
11. When FIN is returned, the tool returns to the initial point in rapid traverse when return to the initial level is specified.

When the repetitive count is specified, operation is repeated from step 1.

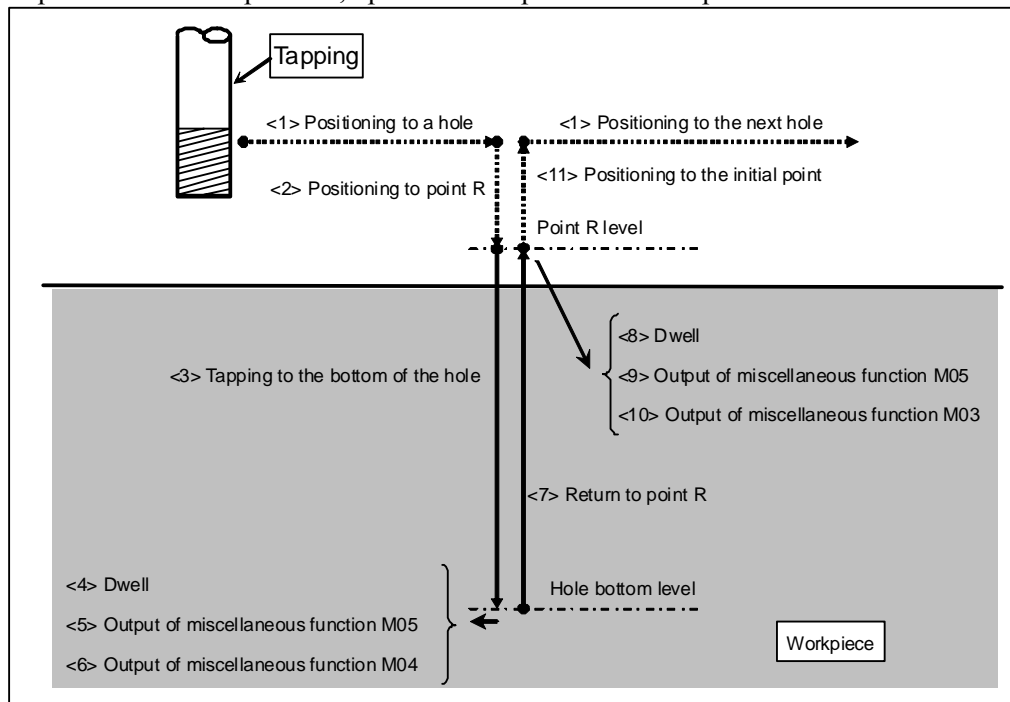

### Peck tapping cycle

When bit 6 (PCT) of parameter No. 5104 is set 1 and bit 5 (PCP) of parameter No. 5200 is set to 1, the peck tapping cycle is used.

Step 3 of the tapping cycle operation described above changes as follows:

- 3-1. The tool cuts the workpiece by the depth of cut  $q$  specified by address  $Q$ .
- 3-2. Miscellaneous function M05 (spindle stop) is output, and the machine enters the FIN wait state.
- 3-3. When FIN is returned, miscellaneous function M04 (reverse spindle rotation) is output, and the machine enters the FIN wait state.



- 3-4. When FIN is returned, the tool is retracted to point R in cutting feed.
- 3-5. Miscellaneous function M05 (spindle stop) is output, and the machine enters the FIN wait state.
- 3-6. When FIN is returned, miscellaneous function M03 (forward spindle rotation) is output, and the machine enters the FIN wait state.
- 3-7. When FIN is returned, the tool moves to the position the clearance  $d$  (parameter No. 5213) apart from the previous cutting point in cutting feed (approach).
- 3-1. The tool cuts the workpiece by the clearance  $d$  (parameter No. 5213) + depth of cut  $q$  (specified by address Q).

Tapping is performed to the bottom of the hole by repeating the above steps.

When a dwell time ( $P$ ) is specified, the tool dwells only when it reaches at the bottom of the hole and reaches point R last.

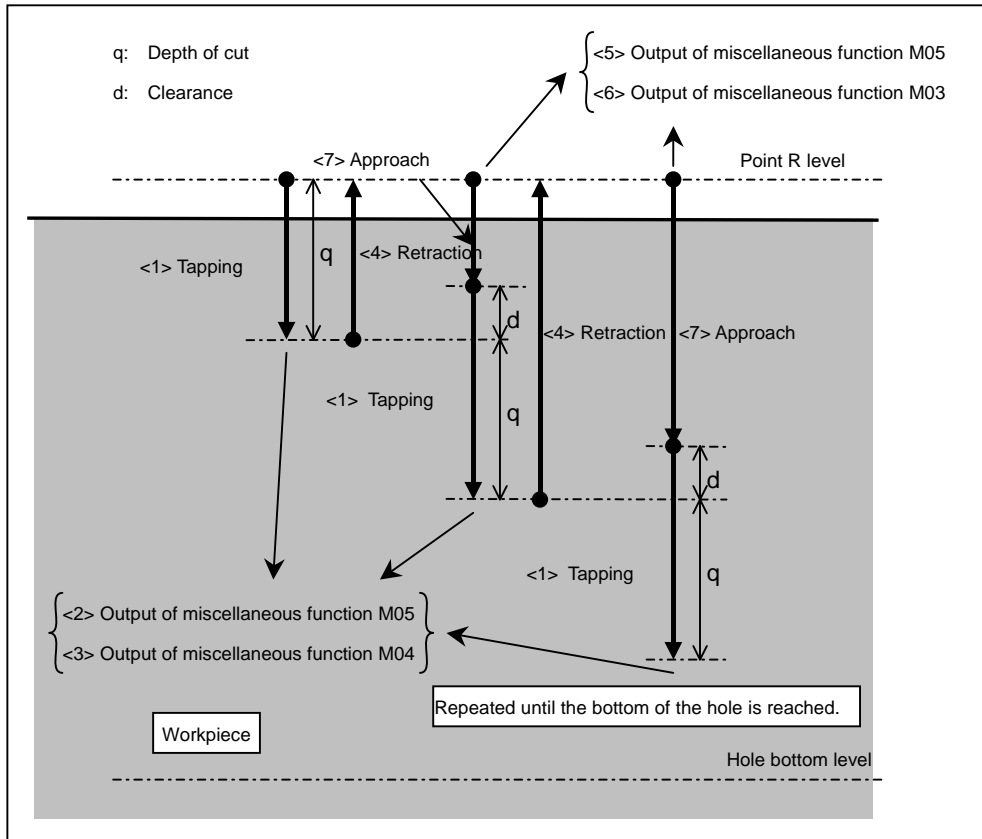

### High-speed peck tapping cycle

When bit 6 (PCT) of parameter No. 5104 is set 1 and bit 5 (PCP) of parameter No. 5200 is set to 0, the high-speed peck tapping cycle is used.

Step 3 of the tapping cycle operation described above changes as follows:

- 3-1. The tool cuts the workpiece by the depth of cut  $q$  specified by address Q.
- 3-2. Miscellaneous function M05 (spindle stop) is output, and the machine enters the FIN wait state.
- 3-3. When FIN is returned, miscellaneous function M04 (reverse spindle rotation) is output, and the machine enters the FIN wait state.
- 3-4. When FIN is returned, the tool is retracted by the retraction distance  $d$  specified by parameter No. 5213 in cutting feed.
- 3-5. Miscellaneous function M05 (spindle stop) is output, and the machine enters the FIN wait state.
- 3-6. When FIN is returned, miscellaneous function M03 (forward spindle rotation) is output, and the machine enters the FIN wait state.

- 3-1. When FIN is returned, the tool cuts the workpiece by the retraction distance  $d$  (parameter No. 5213) + depth of cut  $q$  (specified by address Q).

Tapping is performed to the bottom of the hole by repeating the above steps.

When a dwell time (P) is specified, the tool dwells only when it reaches at the bottom of the hole and reaches point R.

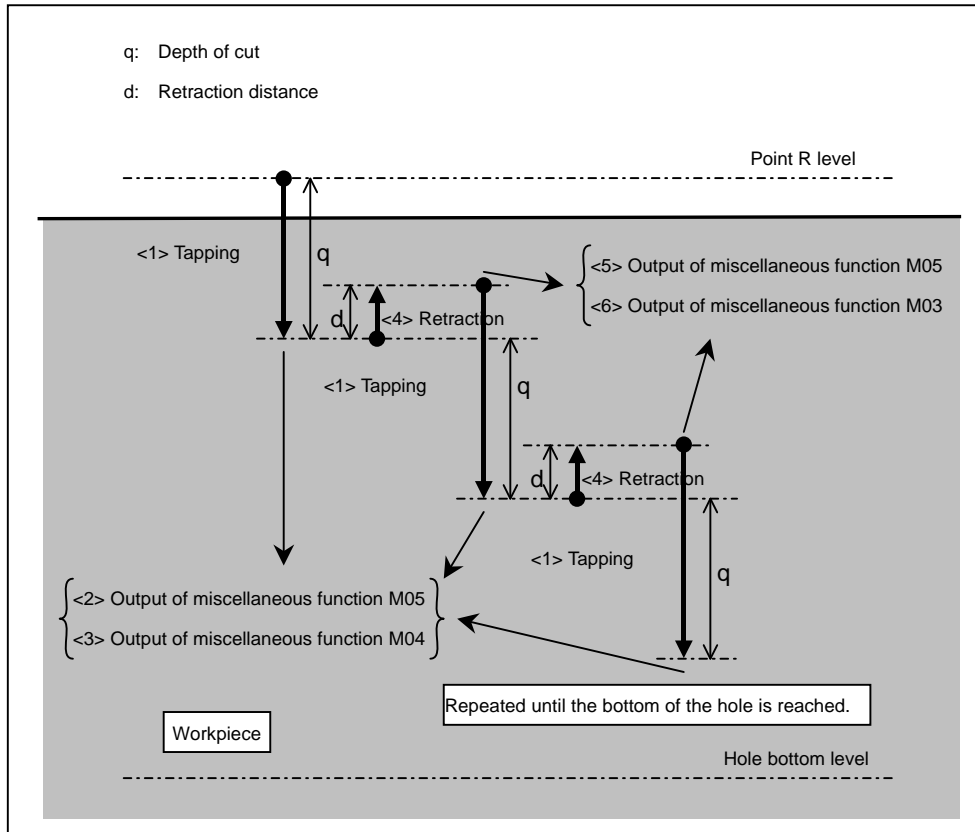

### Notes

- The depth of cut specified by address Q is stored as a modal value until the canned cycle mode is canceled.

In both examples 1 and 2 below, address Q is not specified in the N20 block, but the peck tapping cycle is performed because the value specified by address Q is valid as a modal value. If this operation is not suitable, specify G80 to cancel the canned cycle mode as shown in N15 in example 3 or specify Q0 in the tapping block as shown in N20 in example 4.

#### Example 1

```
N10 G84 X100.0 C0.0 Z-100.0 Q20.0 ;
N20 X150.0 C90.0 ; ← The peck tapping cycle is also performed in this block.
N30 G80 ;
```

#### Example 2

```
N10 G83 X100.0 C0.0 Z-100.0 Q20.0 ;
N20 G84 Z-100.0 ; ← The peck tapping cycle is also performed in this block.
N30 G80 ;
```

#### Example 3

```
N10 G83 X100.0 C0.0 Z-100.0 Q20.0 ;
N15 G80 ; ← The canned cycle mode is canceled.
N20 G84 Z-100.0 ;
N30 G80 ;
```

Example 4

```
N10 G83 X100.0 C0.0 Z-100.0 Q20.0 ;
N20 G84 Z-100.0 Q0 ; ←Q0 is added.
N30 G80 ;
```

2. The unit for the drilling axis is used as the unit of Q. Any sign is ignored.
3. Specify a radius value at address Q even when a diameter axis is used.
4. Perform operation in the peck tapping cycle within point R. That is, set a value which does not exceed point R for d (parameter No. 5213).

**Example**

|                                  |  |
|----------------------------------|--|
| M51 ;                            | Setting C-axis index mode ON                             |
| M3 S2000 ;                       | Rotating the drill                                       |
| G00 X50.0 C0.0 ;                 | Positioning the drill along the X- and C- axes           |
| G84 Z-40.0 R-5.0 P500 F5.0 M31 ; | Drilling hole 1  |
| C90.0 M31 ;                      | Drilling hole 2  |
| C180.0 M31 ;                     | Drilling hole 3  |
| C270.0 M31 ;                     | Drilling hole 4  |
| G80 M05 ;                        | Canceling the drilling cycle and stopping drill rotation |
| M50 ;                            | Setting C-axis index mode off                            |

**4.3.3 Front Boring Cycle (G85) / Side Boring Cycle (G89)**

This cycle is used to bore a hole.

**Format**

```
G85 X(U)_ C(H)_ Z(W)_ R_ P_ F_ K_ M_ ;
or
G89 Z(W)_ C(H)_ X(U)_ R_ P_ F_ K_ M_ ;
X_ C_ or Z_ C_ : Hole position data
Z_ or X_       : The distance from point R to the bottom of the hole
R_             : The distance from the initial level to point R level
P_            : Dwell time at the bottom of a hole
F_            : Cutting feedrate
K_            : Number of repeats (When it is needed.)
M_            : M code for C-axis clamp (When it is needed.)
```

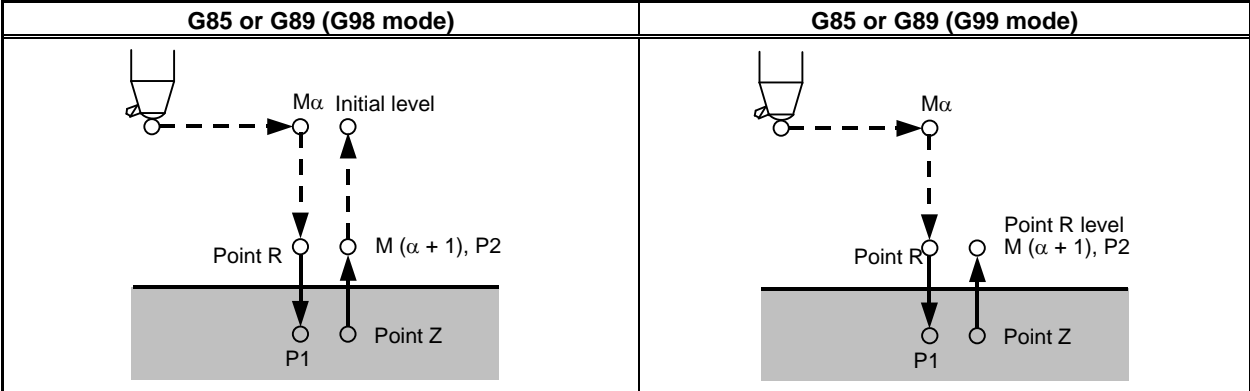

M $\alpha$  : M code for C-axis clamp  
M( $\alpha + 1$ ) : M code for C-axis unclamp

P1 : Dwell specified in the program  
P2 : Dwell specified in parameter No. 5111

### Explanation

After positioning, rapid traverse is performed to point R.  
Drilling is performed from point R to point Z.  
After the tool reaches point Z, it returns to point R at a feedrate twice the cutting feedrate.

### Example

|                                  |  |
|----------------------------------|--|
| M51 ;                            | Setting C-axis index mode ON                             |
| M3 S2000 ;                       | Rotating the drill                                       |
| G00 X50.0 C0.0 ;                 | Positioning the drill along the X- and C-axes            |
| G85 Z-40.0 R-5.0 P500 F5.0 M31 ; | Drilling hole 1  |
| C90.0 M31 ;                      | Drilling hole 2  |
| C180.0 M31 ;                     | Drilling hole 3  |
| C270.0 M31 ;                     | Drilling hole 4  |
| G80 M05 ;                        | Canceling the drilling cycle and stopping drill rotation |
| M50 ;                            | Setting C-axis index mode off                            |

## 4.3.4 Canned Cycle for Drilling Cancel (G80)

G80 cancels canned cycle for drilling.

### Format

|       |
|-------|
| G80 ; |
|-------|

### Explanation

Canned cycle for drilling is canceled to perform normal operation. Point R and point Z are cleared.  
Other drilling data is also canceled (cleared).

### Example

|                                  |  |
|----------------------------------|--|
| M51 ;                            | Setting C-axis index mode ON                             |
| M3 S2000 ;                       | Rotating the drill                                       |
| G00 X50.0 C0.0 ;                 | Positioning the drill along the X- and C-axes.           |
| G83 Z-40.0 R-5.0 P500 F5.0 M31 ; | Drilling hole 1  |
| C90.0 M31 ;                      | Drilling hole 2  |
| C180.0 M31 ;                     | Drilling hole 3  |
| C270.0 M31 ;                     | Drilling hole 4  |
| G80 M05 ;                        | Canceling the drilling cycle and stopping drill rotation |
| M50 ;                            | Setting C-axis index mode off                            |

## 4.3.5 Addition of M Code for Clamp/Unclamp in Canned Cycle for Drilling with

### Overview

Up to two pairs of M codes used for C-axis clamp/unclamp in canned cycles for drilling can be set for each path.

### Details

Set the M codes for C-axis clamp/unclamp in the following parameters.

|                           | Bit 4 of parameter No. 5161=1 |          | Bit 4 of parameter No. 5161=0       |
|---------------------------|-------------------------------|----------|-------------------------------------|
|                           | Pair 1                        | Pair 2   |                                     |
| <b>M code for clamp</b>   | No.5110                       | No.13544 | No.5110                             |
| <b>M code for unclamp</b> | No.13543                      | No.13545 | (Setting in parameter No. 5110 + 1) |

When the M code for clamp set in parameter No. 5110 or 13544 (valid when bit 4 (CME) of parameter No. 5161 is set to 1) is specified in the block for a canned cycle for drilling, the specified M code is output before the tool is fed in rapid traverse to the point-R level after positioned. The M code for unclamp paired with that specified M code is output after the tool retracts to the point-R level.

Example 1:

When bit 4 of parameter No. 5161 is set to 1, and 68, 78, 168, and 178 are specified in parameters Nos. 5110, 13543, 13544 and 13545, respectively, the following M codes are output.

| Command        | Clamp | Unclamp |
|----------------|-------|---------|
| G83X_C_...M68  | M68   | M78     |
| G83X_C_...M168 | M168  | M178    |

Example 2:

When bit 4 of parameter No. 5161 is set to 0, and 68 is specified in parameter No. 5110, respectively, the following M codes are output.

| Command       | Clamp | Unclamp |
|---------------|-------|---------|
| G83X_C_...M68 | M68   | M69     |

#### NOTE

- Both the M codes for clamp and unclamp are set to 0, the setting of the pair is invalid.
- If the same M code for clamp is set for pairs 1 and 2, the setting for pair 1 that is specified in parameter No. 13543 is used as the M code for unclamp.

### 4.3.6 Reducing of Waiting Time of Spindle Speed Arrival in the Canned Cycle for Drilling

#### Overview

When bit 7 (SAC) of parameter No.11507 is set to 1, this function checks the spindle speed arrival signal SAR without waiting time that is set a parameter No.3740 at starting of drilling since the second times in canned cycle for drilling.

Also, this function is available rapid traverse to the initial lever and block overlap in rapid traverse of positioning to a next position of hole in canned cycle for drilling. These improvements reduce the cycle time.

#### Explanation

A canned cycle for drilling consists of a sequence of six operations.

- Operation 1 Positioning of axes X (Z) and C (including also another axis)
- Operation 2 Rapid traverse up to point R level
- Operation 3 Hole machining
- Operation 4 Operation at the bottom of a hole
- Operation 5 Retraction to point R level
- Operation 6 Rapid traverse up to the initial point

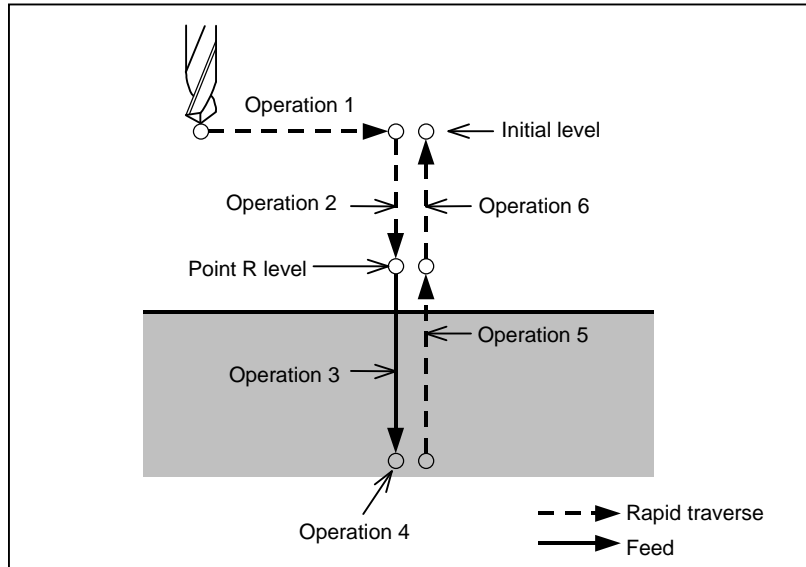

Fig. 4.3.6 (a) Operation sequence of canned cycle for drilling

When bit 7 (SAC) of parameter No.11507 is set to 0, the spindle speed arrival signal SAR is checked after waiting for elapsing time that is set parameter No.3740 for each drilling.

When bit 7 (SAC) of parameter No.11507 is set to 1, in drilling since the second times, the spindle speed arrival signal SAR is checked immediately that is set parameter No.3740 is not related.

However, when command and state are the following conditions, CNC is waiting for elapsing time that is set parameter No.3740 before checking the spindle speed arrival signal SAR.

- Canned cycle for drilling is canceled by G80 or G code of group 01.
- S code is commanded.
- G code of canned cycle for drilling is commanded which is different modal G code.
- The spindle speed arrival signal SAR becomes "0".
- CNC becomes reset state.

### Applied of speed-up of each command

Table of canned cycle for drilling (Series 0i -Fformat)

| G code | Function  | Reducing of waiting time for SAR | Block overlap in rapid traverse |
|--------|---|----------------------------------|---------------------------------|
| G83    | Front drilling cycle                                  | available                        | available                       |
| G84    | Front tapping cycle<br>Front face rigid tapping cycle | -                                | available                       |
| G85    | Front boring cycle                                    | available                        | available                       |
| G87    | Side drilling cycle                                   | available                        | available                       |
| G88    | Side tapping cycle<br>Side face rigid tapping cycle   | -                                | available                       |
| G89    | Side boring cycle                                     | available                        | available                       |

Table of canned cycle for drilling (Series 10/11 format)

| G code | Function                            | Reducing of waiting time for SAR | Block overlap in rapid traverse |
|--------|-------------------------------------|----------------------------------|---------------------------------|
| G81    | Drilling cycle, spot drilling cycle | available                        | available                       |
| G82    | Drilling cycle, counter boring      | available                        | available                       |
| G83    | Peck drilling cycle                 | available                        | available                       |
| G83.1  | High-speed peck drilling cycle      | available                        | available                       |
| G84    | Tapping cycle                       | -                                | available                       |
| G84.2  | Rigid tapping cycle                 | -                                | available                       |
| G85    | Boring cycle                        | available                        | available                       |
| G89    | Boring cycle                        | available                        | available                       |

## Manual Handle Retrace

This function is available in the check mode of manual handle retrace.

### In case of canceling of canned cycle for drilling

|                | Forward                         | Backward                        | Re-forward                      |
|----------------|---------------------------------|---------------------------------|---------------------------------|
| G00 X_ Z_ ;    |                                 |                                 |                                 |
| G83 Z_ C_ F_ ; | Parameter No.3740 is available. | Not waiting time.               | Parameter No.3740 is available. |
| C_ ;           | Not waiting time.               | Not waiting time.               | Not waiting time.               |
| C_ ;           | Not waiting time.               | Parameter No.3740 is available. | Not waiting time.               |
| G80 ;          |                                 |                                 |                                 |

### In case of not canceling of canned cycle for drilling

|                | Forward                         | Backward          | Re-forward        |
|----------------|---------------------------------|-------------------|-------------------|
| G00 X_ Z_ ;    |                                 |                   |                   |
| G83 Z_ C_ F_ ; | Parameter No.3740 is available. | Not waiting time. | Not waiting time. |
| C_ ;           | Not waiting time.               | Not waiting time. | Not waiting time. |
| C_ ;           | Not waiting time.               | Not waiting time. | Not waiting time. |
| G80 ;          |                                 |                   |                   |

## 4.3.7 Precautions to be Taken by Operator

### - Reset and emergency stop

Even when the controller is stopped by resetting or emergency stop in the course of drilling cycle, the drilling mode and drilling data are saved; with this mind, therefore, restart operation.

### - Single block

When drilling cycle is performed with a single block, the operation stops at the end points of operations 1, 2, 6 in Fig. 4.3 (a).

Consequently, it follows that operation is started up 3 times to drill one hole. The operation stops at the end points of operations 1, 2 with the feed hold lamp ON. If there is a remaining repetitive count at the end of operation 6, the operation is stopped by feed hold. If there is no remaining repetitive count, the operation is stopped in the single block stop state.

### - Feed hold

When "Feed Hold" is applied between operations 3 and 5 by G84/G88, the feed hold lamp lights up immediately if the feed hold is applied again to operation 6.

### - Override

During operation with G84 and G88, the feedrate override is 100%.

## 4.4 RIGID TAPPING

---

Front face tapping cycles (G84) and side face tapping cycles (G88) can be performed either in conventional mode or rigid mode.

In conventional mode, the spindle is rotated or stopped, in synchronization with the motion along the tapping axis according to miscellaneous functions M03 (spindle CW rotation), M04 (spindle CCW rotation), and M05 (spindle stop).

In rigid mode, the spindle motor is controlled in the same way as a control motor, by the application of compensation to both motion along the tapping axis and that of the spindle.

For rigid tapping, each turn of the spindle corresponds to a certain amount of feed (screw lead) along the spindle axis. This also applies to acceleration/deceleration. This means that rigid tapping does not demand the use of float tappers as in the case of conventional tapping, thus enabling high-speed, high-precision tapping.

When the multi-spindle control function is valid (the bit 3 (MSP) of parameter No. 8133 is 1), the second or third spindles can be used for rigid tapping.

### **NOTE**

When bit 3 (NRG) of parameter No.8135 is 0, this function can be used.



### 4.4.1 Front Face Rigid Tapping Cycle (G84) / Side Face Rigid Tapping Cycle (G88)

Controlling the spindle motor in the same way as a servo motor in rigid mode enables high-speed tapping.

#### Format

|   |                       |
|---|-----------------------|
| <p><b>G84 X (U)_ C (H)_ Z (W)_ R_ P_ F_ K_ M_ ;</b><br/>                 or<br/> <b>G88 Z (W)_ C (H)_ X (U)_ R_ P_ F_ K_ M_ ;</b></p> <p>X_ C_ or Z_ C_ : Hole position data<br/>                 Z_ or X_ : The distance from point R to the bottom of the hole<br/>                 R_ : The distance from the initial level to point R level<br/>                 P_ : Dwell time at the bottom of a hole<br/>                 F_ : Cutting feedrate<br/>                 K_ : Number of repeats (When it is needed.)<br/>                 Number of repeats is specified by address L_, in case of bit 1 (FCV) of parameter No.0001 = 1.<br/>                 M_ : M code for C-axis clamp (when it is needed.)</p> |                       |
| G84 or G88 (G98 mode)   | G84 or G88 (G99 mode) |
|   |                       |

P2 performs dwelling of C-axis unclamp. (The dwell time is set in parameter No. 5111.)

In front face rigid tapping (G84), the plane first axis is used as the drilling axis and the other axes are used as positioning axes.

| Bit 0 (RTX) of parameter No. 5209 | Plane selection  | Drilling axis |
|-----------------------------------|------------------|---------------|
| 0                                 | G17: Xp-Yp plane | Xp            |
|                                   | G18: Zp-Xp plane | Zp            |
|                                   | G19: Yp-Zp plane | Yp            |
| 1                                 |                  | Zp            |

Xp: X axis or its parallel axis  
 Yp: Y axis or its parallel axis  
 Zp: Z axis or its parallel axis

In side face rigid tapping (G88), the plane first axis is used as the drilling axis and the other axes are used as positioning axes.

| Bit 0 (RTX) of parameter No. 5209 | Plane selection  | Drilling axis |
|-----------------------------------|------------------|---------------|
| 0                                 | G17: Xp-Yp plane | Yp            |
|                                   | G18: Zp-Xp plane | Xp            |
|                                   | G19: Yp-Zp plane | Zp            |
| 1                                 |                  | Xp            |

Xp: X axis or its parallel axis  
 Yp: Y axis or its parallel axis  
 Zp: Z axis or its parallel axis

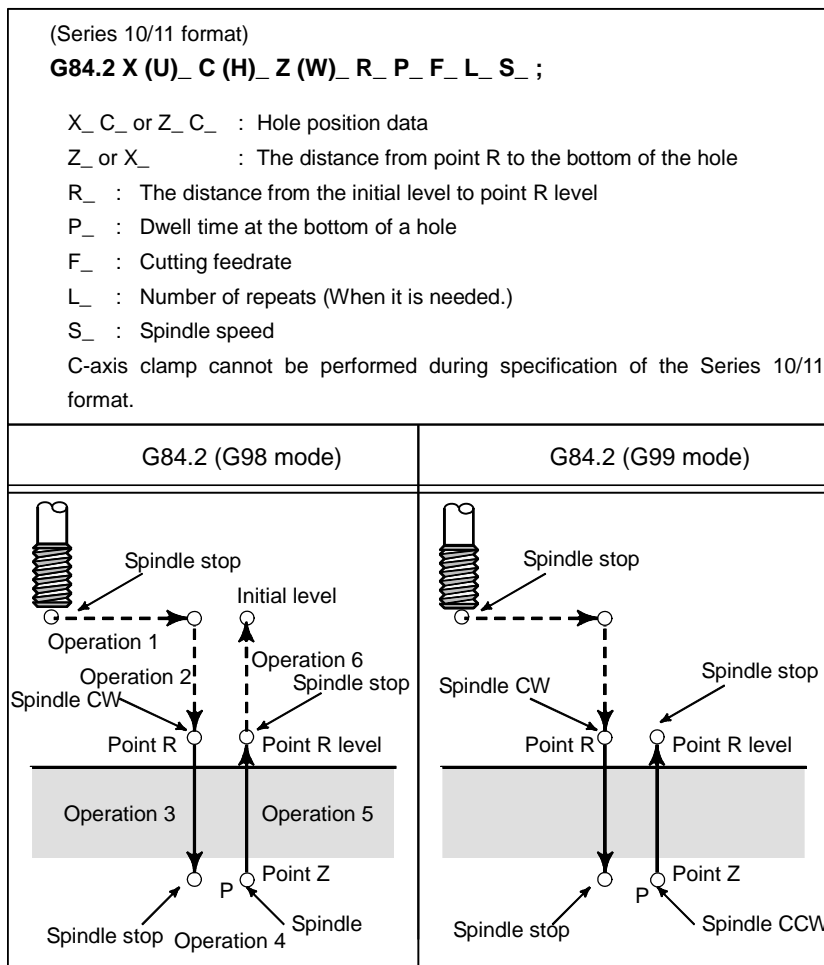

A G code cannot discriminate between front face tapping cycle and side face tapping cycle using Series 10/11 format commands(G84.2). The drilling axis is determined by plane selection (G17/G18/G19). Specify the plane selection that becomes equivalent to front face tapping cycle or side face tapping cycle as appropriate. (When FXY (bit 0 of parameter No. 5101) is 0, the Z-axis is used as the drilling axis. When FXY is 1, plane selection is as Table 4.4.1 (a).)

Table 4.4.1 (a)

| Plane selection  | Drilling axis |
|------------------|---------------|
| G17: Xp-Yp plane | Zp            |
| G18: Zp-Xp plane | Yp            |
| G19: Yp-Zp plane | Xp            |

Xp: X axis or its parallel axis  
 Yp: Y axis or its parallel axis

Zp: Z axis or its parallel axis

Thus, the rigid tapping mode can be specified in two formats: G84/G88(FS0i-F format) and G84.2(FS10/11 format). A usable format can be selected by parameter setting.

| Parameter                         |                                   | Executable command format   |
|-----------------------------------|-----------------------------------|---|
| Bit 1 (FCV) of parameter No. 0001 | Bit 3 (F16) of parameter No. 5102 |   |
| 0                                 | -                                 | FS0i-F format only (The number of repeats is specified using address K.)              |
| 1                                 | 0                                 | FS10/11 format or FS0i-F format (The number of repeats is specified using address L.) |
| 1                                 | 1                                 | FS0i-F format only (The number of repeats is specified using address L.)              |

## Explanation

Once positioning for the X-axis (G84) or Z-axis (G88) has been completed, the spindle is moved, by rapid traverse, to point R. Tapping is performed from point R to point Z, after which the spindle stops and observes a dwell time. Then, the spindle starts reverse rotation, retracts to point R, stops rotating, then moves to the initial level by rapid traverse.

During tapping, the feedrate override and spindle override are assumed to be 100%. For retraction (operation 5), however, a fixed override of up to 2000% can be applied by setting bit 4 (DOV) of parameter No. 5200, bit 3 (OVU) of parameter No. 5201, and parameter No. 5211.

### - Rigid mode

Rigid mode can be specified by applying any of the following methods:

- (1) Specifying M29S\*\*\*\*\* before a tapping block
- (2) Specifying M29S\*\*\*\*\* within a tapping block
- (3) Handling G84 or G88 as a G code for rigid tapping (Set bit 0 (G84) of parameter No. 5200 to 1.)

### - Thread lead

In feed per minute mode, the feedrate divided by the spindle speed is equal to the thread lead. In feed per rotation mode, the feedrate is equal to the thread lead.

### - Series 10/11 format command

Rigid tapping can be performed using Series 10/11 format commands.

### - Acceleration/deceleration after interpolation

Linear or bell-shaped acceleration/deceleration can be applied. Details are given later.

### - Look-ahead acceleration/deceleration before interpolation

Look-ahead acceleration/deceleration before interpolation is invalid.

### - Override

Various types of override functions are invalid. The following override functions can be enabled by setting corresponding parameters:

- (1) Extraction override
- (2) Override signal

### - Dry run

Dry run can be executed also in G84 (G88). When dry run is executed at the feedrate for the drilling axis in G84 (G88), tapping is performed according to the feedrate. Note that the spindle speed becomes faster at a higher dry run feedrate.

- **Machine lock**

Machine lock can be executed also in G84 (G88).

When G84 (G88) is executed in the machine lock state, the tool does not move along the drilling axis. Therefore, the spindle does not also rotate.

- **Reset**

When a reset is performed during rigid tapping, the rigid tapping mode is canceled and the spindle motor enters the normal mode. Note that the G84 (G88) mode is not canceled in this case when bit 6 (CLR) of parameter No. 3402 is set.

- **Interlock**

Interlock can also be applied in G84 (G88).

- **Feed hold and single block**

When bit 6 (FHD) of parameter No. 5200 is set to 0, feed hold and single block are invalid in the G84 (G88) mode. When this bit is set to 1, they are valid.

- **Manual feed**

For rigid tapping by manual handle feed, see the section "Rigid Tapping by Manual Handle." With other manual operations, rigid tapping cannot be performed.

- **Backlash compensation**

In the rigid tapping mode, backlash compensation is applied to compensate the lost motion when the spindle rotates clockwise or counterclockwise. Set the amount of backlash in parameters Nos. 5321 to 5324.

Along the drilling axis, backlash compensation has been applied.

- **C-axis clamp, C-axis unclamp**

It is possible to specify an M code for mechanically fixing or releasing the C-axis during rigid tapping. Adding an M code for clamp to the G84 (G88) block outputs both M codes. Descriptions of timing are provided later.

An M code for clamp is set in parameter No. 5110. An M code for unclamp is assumed as Table 4.4.1 (b) depending on the setting of parameter No. 5110.

Table 4.4.1 (b)

| Parameter No.5110      |  |
|------------------------|--|
| 0                      | Non-0  |
| No M codes are output. | The setting of parameter No.5110 + 1 is assumed. |

**Limitation**

- **Axis switching**

Before the drilling axis can be changed, the canned cycle must be canceled. If the drilling axis is changed in rigid mode, alarm PS0206, "CAN NOT CHANGE PLANE (RIGID TAP)" is issued.

- **S commands**

When a value exceeding the maximum rotation speed for the gear being used is specified, alarm PS0200, "ILLEGAL S CODE COMMAND" is issued. If such a command that the number of pulses of 8 msec is 32768 or more on the detection unit level or the number of pulses of 8 msec is 32768 or more for a serial spindle is specified, alarm PS0202, "POSITION LSI OVERFLOW" is issued.

<Example>

For a built-in motor equipped with a detector having a resolution of 4095 pulses per rotation, the maximum spindle speed during rigid tapping is as follows:

$$(4095 \times 1000 \div 8 \times 60) \div 4095 = 7500 \text{ (min}^{-1}\text{)}$$

For a serial spindle

$$(32767 \times 1000 \div 8 \times 60) \div 4095 = 60012 \text{ (min}^{-1}\text{)} \text{ [Note: Ideal value]}$$

#### - F commands

Specifying a value larger than the upper limit for cutting feed will cause alarm PS0201, "FEEDRATE NOT FOUND IN RIGID TAP" to be issued.

#### - Unit of F command

|     | Metric input | Inch input     | Remarks                           |
|-----|--------------|----------------|-----------------------------------|
| G98 | 1mm/min      | 0.01inch/min   | Decimal point programming allowed |
| G99 | 0.01mm/rev   | 0.0001inch/rev | Decimal point programming allowed |

#### - M29

If an S command and axis movement are specified between M29 and G84, alarm PS0203, "PROGRAM MISS AT RIGID TAPPING" is issued. If M29 is specified in a tapping cycle, alarm PS0204, "ILLEGAL AXIS OPERATION" is issued.

#### - P

Specify P in a block that performs drilling. If P is specified in a non-drilling block, it is not stored as modal data.

#### - Cancel

Do not specify a G code of the 01 group (G00 to G03) and G84 in a single block. Otherwise, G84 will be canceled.

#### - Tool offset

In the canned cycle mode, tool offsets are ignored.

#### - Program restart

A program cannot be restarted during rigid tapping.

#### - R

The value of R must be specified in a block which performs drilling. If the value is specified in a block which does not perform drilling, it is not stored as modal data.

#### - Subprogram call

In the canned cycle mode, specify the subprogram call command M98P\_ in an independent block.

#### - Constant surface speed control

If rigid tapping is commanded during constant surface speed control, alarm (PS0200), "ILLEGAL S CODE COMMAND" is issued. Command rigid tapping after canceling constant surface speed control.

### Example

Tapping axis feedrate: 1000 mm/min

Spindle speed: 1000 min<sup>-1</sup>

Screw lead: 1.0 mm

<Programming for feed per minute>

G98 ; ..... Command for feed per minute

G00 X100.0 ; ..... Positioning

M29 S1000; ..... Command for specifying rigid mode

G84 Z-100.0 R-20.0 F1000 ; ..... Rigid tapping

<Programming for feed per rotation>

- G99 ; ..... Command for feed per rotation
- G00 X100.0 ; ..... Positioning
- M29 S1000 ; ..... Command for specifying rigid mode
- G84 Z-100.0 R-20.0 F1.0 ; ..... Rigid tapping

### 4.4.2 Peck Rigid Tapping Cycle (G84 or G88)

Tapping a deep hole in rigid tapping mode may be difficult due to chips sticking to the tool or increased cutting resistance. In such cases, the peck rigid tapping cycle is useful.

In this cycle, cutting is performed several times until the bottom of the hole is reached. Two peck tapping cycles are available: High-speed peck tapping cycle and standard peck tapping cycle. These cycles are selected using the bit 5 (PCP) of parameter No. 5200.

#### Format

When rigid tapping is specified with G84 (G88) if bit 5 (PCP) of parameter No. 5200 = 0, high-speed peck rigid tapping is assumed.

|  |                      |
|--|----------------------|
| <p><b>G84 X(U)_C(H)_Z(W)_R_P_Q_F_K_M_ ;</b><br/>                 or<br/> <b>G88 Z(W)_C(H)_X(U)_R_P_Q_F_K_M_ ;</b></p> <p>X_C_ or Z_C_ : Hole position data<br/>                 Z_ or X_ : The distance from point R to the bottom of the hole<br/>                 R_ : The distance from the initial level to point R level<br/>                 P_ : Dwell time at the bottom of the hole<br/>                 Q_ : Depth of cut for each cutting feed<br/>                 F_ : The cutting feedrate<br/>                 K_ : Number of repeats (when it is needed.)<br/>                 M_ : M code for C-axis clamp (when it is needed.)</p> |                      |
| G84 or G88(G98 mode)   | G84 or G88(G99 mode) |
|  |                      |

- High-speed peck rigid tapping cycle
- In the first cutting from point R, perform cutting by depth "q" specified by address Q while rotating the spindle in the forward direction (operation <1>).
- Then, perform returning by the amount specified by parameter No. 5213 while rotating the spindle in the reverse direction (operation <2>).
- Then, perform tapping by (d+q) while rotating the spindle in the forward direction (operation <3>).

Repeat operations <2> and <3> until the bottom of the hole is reached.

The cutting speed and rigid tapping time constant are used for operations <1> and <3>.

For operation <2> and travel from the bottom of the hole (point Z) to point R, rigid tapping extract override is enabled and the rigid tapping extract time constant is used.

When rigid tapping is specified with G84 (G88) if bit 5 (PCP) of parameter No. 5200 = 1, peck rigid tapping is assumed.

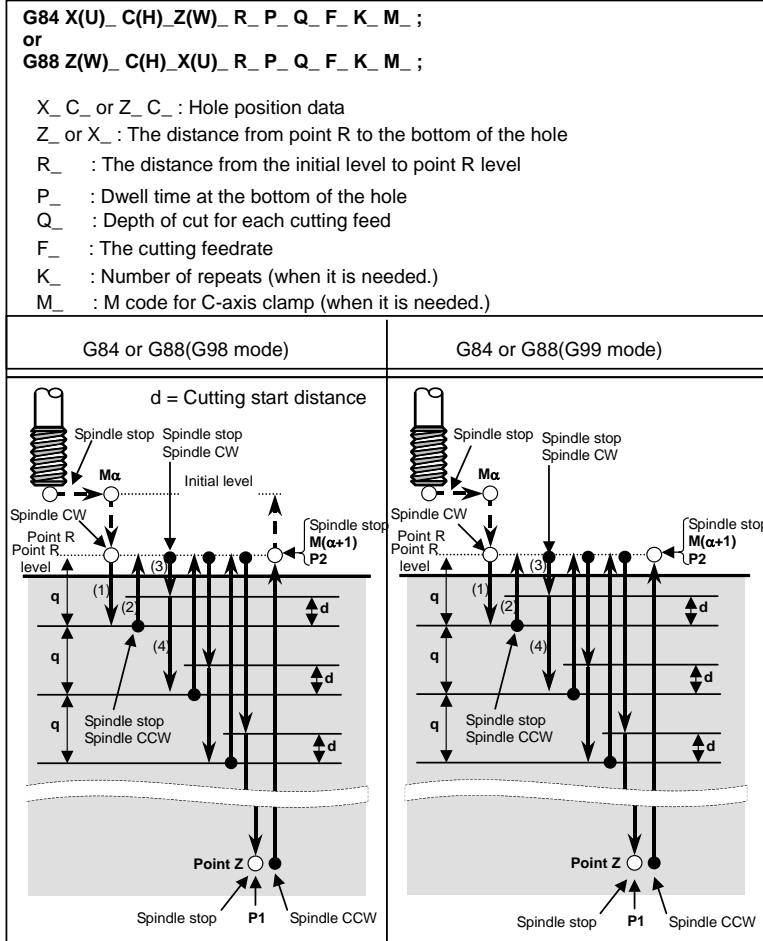

- Peck rigid tapping cycle  
 In the first cutting from point R, perform cutting by depth "q" specified by address Q while rotating the spindle in the forward direction (operation <1>). Then, return to point R by rotating the spindle in the reverse direction (operation <2>). Then, rotate the spindle in the forward direction and perform cutting to the position indicated by [(Position to which cutting was performed previously) - (Cutting start distance set in parameter No. 5213)] as movement to the cutting start point (operation <3>). Continue cutting by (d+q) (operation <4>).  
 Repeat operations <2> to <4> until the bottom of the hole is reached.  
 The cutting speed and rigid tapping time constant are used for operations <1> and <4>.  
 For operations <2>, <3>, and travel from the bottom of the hole (point Z) to point R, rigid tapping extract override is enabled and the rigid tapping extract time constant is used.

The symbols in the figure above indicate the following operations.

- > : Positioning (Rapid traverse G00)
- : Cutting feed (Linear interpolation G01)
- P1 : Dwell programmed by the address P command
- M $\alpha$  : Output of the M code for C-axis clamp (The  $\alpha$  value is set in parameter No. 5110.)
- M( $\alpha+1$ ) : Output of the M code for C-axis unclamp
- P2 : Dwell set by parameter No.5111

**Note** P1, M $\alpha$ , M( $\alpha+1$ ), and P2 are not executed or output without being specified or set.

**Explanation**

- **Cutting start distance**

Cutting start distance d is set by parameter No. 5213.

- **Amount of return**

Amount of return for each time d is set by parameter No. 5213.

- **Return speed**

For the speed of return operation, a maximum of 2000% of override can be enabled by setting bit 4 (DOV) of parameter No. 5200, bit 3 (OVU) of parameter No. 5201, and parameter No. 5211 as with travel from the bottom of the hole (point Z) to point R.

- **Speed during cutting into the cutting start point**

For the speed during cutting into the cutting start point, a maximum of 2000% of override can be enabled by setting bit 4 (DOV) of parameter No. 5200, bit 3 (OVU) of parameter No. 5201, and parameter No. 5211 as with travel from the bottom of the hole (point Z) to point R.

- **Acceleration/deceleration after interpolation**

Linear or bell-shaped acceleration/deceleration can be applied.

- **Look-ahead acceleration/deceleration before interpolation**

Look-ahead acceleration/deceleration before interpolation is invalid.

- **Override**

Various types of override functions are invalid. The following override functions can be enabled by setting corresponding parameters:

- Extraction override
- Override signal

Details are given later.

- **Dry run**

Dry run can be executed also in G84 (G88). When dry run is executed at the feedrate for the drilling axis in G84 (G88), tapping is performed according to the feedrate. Note that the spindle speed becomes faster at a higher dry run feedrate.

- **Machine lock**

Machine lock can be executed also in G84 (G88).

When G84 (G88) is executed in the machine lock state, the tool does not move along the drilling axis. Therefore, the spindle does not also rotate.

- **Reset**

When a reset is performed during rigid tapping, the rigid tapping mode is canceled and the spindle motor enters the normal mode. Note that the G84 (G88) mode is not canceled in this case when bit 6 (CLR) of parameter No. 3402 is set.

- **Interlock**

Interlock can also be applied in G84 (G88).

- **Feed hold and single block**

When bit 6 (FHD) of parameter No. 5200 is set to 0, feed hold and single block are invalid in the G84 (G88) mode. When this bit is set to 1, they are valid.

- **Manual feed**

For rigid tapping by manual handle feed, see the section "Rigid Tapping by Manual Handle."  
With other manual operations, rigid tapping cannot be performed.

- **Backlash compensation**

In the rigid tapping mode, backlash compensation is applied to compensate the lost motion when the spindle rotates clockwise or counterclockwise. Set the amount of backlash in parameters Nos. 5321 to 5324.

Along the drilling axis, backlash compensation has been applied.

- **Series 10/11 format**

When bit 1 (FCV) of parameter No. 0001 is set to 1, execution is enabled with G84.2. The same operation as with G84 is performed. However, the command format for the repetitive count is L.



**Limitation****- Axis switching**

Before the drilling axis can be changed, the canned cycle must be canceled. If the drilling axis is changed in rigid mode, alarm PS0206, "CAN NOT CHANGE PLANE (RIGID TAP)" is issued.

**- S commands**

- If a speed higher than the maximum speed for the gear being used is specified, alarm PS0200, "ILLEGAL S CODE COMMAND" is issued.

- When the rigid tapping canned cycle is cancelled, the S command used for rigid tapping is cleared to S0.

**- Distribution amount for the spindle**

The maximum distribution amount is as follows (displayed on diagnostic data No. 451):

- For a serial spindle: 32,767 pulses per 4 msec

This amount is changed according to the gear ratio setting for the position coder or rigid tapping command. If a setting is made to exceed the upper limit, alarm PS0202, "POSITION LSI OVERFLOW" is issued.

**- F command**

Specifying a value larger than the upper limit for cutting feed will cause alarm PS0011, "FEED ZERO (COMMAND)" to be issued.

**- Unit of F command**

|     | Metric input | Inch input     | Remarks                           |
|-----|--------------|----------------|-----------------------------------|
| G98 | 1mm/min      | 0.01inch/min   | Decimal point programming allowed |
| G99 | 0.01mm/rev   | 0.0001inch/rev | Decimal point programming allowed |

**- M29**

If an S command and axis movement are specified between M29 and G84, alarm PS0203 is issued. If M29 is specified in a tapping cycle, alarm PS0204 is issued.

**- P/Q**

Specify P and Q in a block that performs drilling. If they are specified in a block that does not perform drilling, they are not stored as modal data.

When Q0 is specified, the peck rigid tapping cycle is not performed.

**- Cancel**

Do not specify a G code of the 01 group (G00 to G03) and G84 in a single block. Otherwise, G84 will be canceled.

**- Tool offset**

In the canned cycle mode, tool offsets are ignored.

**- Subprogram call**

In the canned cycle mode, specify the subprogram call command M98P\_ in an independent block.

**- Amount of return and cutting start distance**

Set the amount of return and cutting start distance (parameter No. 5213) so that the tool does not overshoot point R.

**- Constant surface speed control**

If rigid tapping is commanded during constant surface speed control, alarm (PS0200), "ILLEGAL S CODE COMMAND" is issued. Command rigid tapping after canceling constant surface speed control.

### 4.4.3 Canned Cycle Cancel (G80)

The rigid tapping canned cycle is canceled. For how to cancel this cycle, see II-4.3.4.

**NOTE**

When the rigid tapping canned cycle is cancelled, the S value used for rigid tapping is also cleared (as if S0 is specified). Accordingly, the S command specified for rigid tapping cannot be used in a subsequent part of the program after the cancellation of the rigid tapping canned cycle. After canceling the rigid tapping canned cycle, specify a new S command as required.

### 4.4.4 Override during Rigid Tapping

Various types of override functions are invalid. The following override functions can be enabled by setting corresponding parameters:

- Extraction override
- Override signal

#### 4.4.4.1 Extraction override

For extraction override, the fixed override set in the parameter or override specified in a program can be enabled at extraction (including retraction during peck drilling/high-speed peck drilling).

#### Explanation

**- Specifying the override in the parameter**

Set bit 4 (DOV) of parameter No. 5200 to 1 and set the override in parameter No. 5211.

An override from 0% to 200% in 1% steps can be set. Bit 3 (OVU) of parameter No. 5201 can be set to 1 to set an override from 0% to 2000% in 10% steps.

**- Specifying the override in a program**

Set bit 4 (DOV) of parameter No. 5200 and bit 4 (OV3) of parameter No. 5201 to 1. The spindle speed at extraction can be specified in the program.

Specify the spindle speed at extraction using address "J" in the block in which rigid tapping is specified.

Example)

To specify 1000 min<sup>-1</sup> for S at cutting and 2000 min<sup>-1</sup> for S at extraction

```
M29 S1000 ;
G84 Z-100.0 F1000.0 J2000 ;
```

The difference in the spindle speed is converted to the actual override by the following calculation.

Therefore, the spindle speed at extraction may not be the same as that specified at address "J". If the override does not fall in the range between 100% and 200%, it is assumed to be 100%.

$$\text{Override (\%)} = \frac{\text{Spindle speed at extraction (specified at J)}}{\text{Spindle speed (specified at S)}} \times 100$$

The override to be applied is determined according to the setting of parameters and that in the command as shown in the Table 4.4.4.1 (a).

Table 4.4.4.1 (a)

| Command   |  | Parameter setting      | DOV = 1 |                    | DOV = 0 |
|---|--|------------------------|---------|--------------------|---------|
|   |  |                        | OV3 = 1 | OV3 = 0            |         |
| Spindle speed at extraction specified at address "J"    | Within the range between 100% to 200%  | Command in the program | 100%    | Parameter No. 5211 | 100%    |
|   | Outside the range between 100% to 200% | 100%                   |         |                    |         |
| No spindle speed at extraction specified at address "J" |  | Parameter No. 5211     |         |                    |         |

**NOTE**

- Do not use a decimal point in the value specified at address "J".  
If a decimal point is used, the value is assumed as follows:  
Example)  
When the increment system for the reference axis is IS-B
  - When pocket calculator type decimal point programming is not used  
The specified value is converted to the value for which the least input increment is considered.  
"J200." is assumed to be 200000 min<sup>-1</sup>.
  - When pocket calculator type decimal point programming is used  
The specified value is converted to the value obtained by rounding down to an integer.  
"J200." is assumed to be 200 min<sup>-1</sup>.
- Do not use a minus sign in the value specified at address "J".  
If a minus sign is used, a value outside the range between 100% to 200% is assumed.
- The maximum override is obtained using the following equation so that the spindle speed to which override at extraction is applied do not exceed the maximum used gear speed (specified in parameters Nos. 5241 to 5244). For this reason, the obtained value is not the same as the maximum spindle speed depending on the override.  

$$\text{Maximum override (\%)} = \frac{\text{Maximum spindle speed (specified in parameters)}}{\text{Spindle speed (specified at S)}} \times 100$$
- When a value is specified at address "J" for specifying the spindle speed at extraction in the rigid tapping mode, it is valid until the canned cycle is canceled.

**4.4.4.2 Override signal**

By setting bit 4 (OVS) of parameter No. 5203 to 1, override can be applied to cutting/extraction operation during rigid tapping as follows:

- Applying override using the feedrate override signal  
(When the second feedrate override signal is enabled, the second feedrate override is applied to the feedrate to which feedrate override is applied.)
- Canceling override using the override cancel signal

There are the following relationships between this function and override to each operation:

- At cutting
 

|  |  |
|--|--|
| When the override cancel signal is set to 0: | Value specified by the override signal |
| When the override cancel signal is set to 1: | 100%                                   |

- (2) At extraction
- When the override cancel signal is set to 0: Value specified by the override signal
  - When the override cancel signal is set to 1 and extraction override is disabled:  
100%
  - When the override cancel signal is set to 1 and extraction override is enabled:  
Value specified for extraction override

**NOTE**

- 1 The maximum override is obtained using the following equation so that the spindle speed to which override is applied do not exceed the maximum used gear speed (specified in parameters Nos. 5241 to 5244). For this reason, the obtained value is not the same as the maximum spindle speed depending on the override.

$$\text{Maximum override (\%)} = \frac{\text{Maximum spindle speed (specified in parameters)}}{\text{Spindle speed (specified at S)}} \times 100$$

- 2 Since override operation differs depending on the machine in use, refer to the manual provided by the machine tool builder.

## 4.5 CANNED GRINDING CYCLE (FOR GRINDING MACHINE)

With the canned grinding cycle, repetitive machining operations that are specific to grinding and are usually specified using several blocks can be specified using one block including a G function. So, a program can be created simply. At the same time, the size of a program can be reduced, and the memory can be used more efficiently. Four types of canned grinding cycles are available:

- Traverse grinding cycle (G71) (G72 when G code system C is used)
- Traverse direct constant-size grinding cycle (G72) (G73 when G code system C is used)
- Oscillation grinding cycle (G73) (G74 when G code system C is used)
- Oscillation direct constant-size grinding cycle (G74) (G75 when G code system C is used)

In the descriptions below, an axis used for cutting with a grinding wheel and an axis used for grinding with a grinding wheel are referred to as follows:

Axis used for cutting with a grinding wheel: Cutting axis  
Axis used for grinding with a grinding wheel: Grinding axis

During execution of a canned grinding cycle, the following functions cannot be used:

- Programmable mirror image
- Coordinate system rotation
- 3-dimensional coordinate conversion

For a depth of cut on a cutting axis and a distance of grinding on a grinding axis, the incremental system (parameter No. 1013) for the reference axis (parameter No. 1031) is used. If 0 is set in parameter No. 1031 (reference axis), the incremental system for the first axis is used.

### WARNING

The G codes for canned grinding cycles G71, G72, G73, and G74 (G72, G73, G74, and G75 when G code system C is used) are G codes of group 01. A G code for cancellation such as G80 used for a canned cycle for drilling is unavailable. By specifying a G code of group 00 other than G04, modal information such as a depth of cut is cleared but no canned grinding cycle can be canceled. To cancel a canned grinding cycle, a G code of group 01 other than G71, G72, G73, and G74 needs to be specified. So, when switching to another axis move command from G71, G72, G73 or G74, for example, be sure to specify a G code of group 01 such as G00 or G01 to cancel the canned grinding cycle. If another axis move command is specified without canceling the canned grinding cycle, an unpredictable operation can result because of continued cycle operation.

### NOTE

- 1 To use this function, the option "Grinding function A" or "Grinding function B" is required.
- 2 A canned grinding cycle and multiple repetitive canned cycle cannot be used simultaneously.  
When the canned grinding cycle is enabled, the multiple repetitive canned cycle is disabled.

**NOTE**

- 3 If the G code for a canned grinding cycle (G71, G72, G73, or G74) is specified, the canned grinding cycle is executed according to the values of A, B, W, U, I, and K preserved as modal data while the cycle is valid, even if a block specified later specifies none of G71, G72, G73, and G74.

Example:

```
G71 A_ B_ W_ U_ I_ K_ H_ ;
```

    ; ← The canned grinding cycle is executed even if an empty block is specified.  
%

- 4 When switching from a canned cycle for drilling to a canned grinding cycle, specify G80 to cancel the canned cycle for drilling.
- 5 When switching from a canned grinding cycle to another axis move command, cancel the canned cycle according to the warning above.

## 4.5.1 Traverse Grinding Cycle (G71)

A traverse grinding cycle can be executed.

### Format

**G71 A\_ B\_ W\_ U\_ I\_ K\_ H\_ ;**

A\_ : First depth of cut (The cutting direction depends on the sign.)  
 B\_ : Second depth of cut (The cutting direction depends on the sign.)  
 W\_ : Grinding range (The grinding direction depends on the sign.)  
 U\_ : Dwell time  
 I\_ : Feedrate for A and B  
 K\_ : Feedrate for W  
 H\_ : Repetitive count (from 1 to 9999)

**G71**

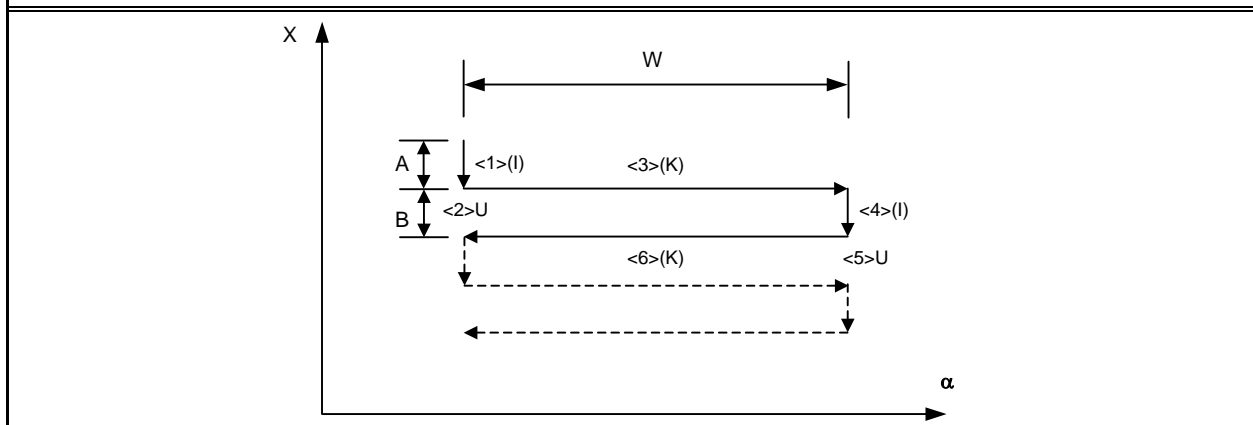

### Explanation

The traverse grinding cycle consists of six operations.

The operations from <1> to <6> are repeated until the repetitive count specified in address H is reached. In the case of single block operation, the operations from <1> to <6> are executed with one cycle start operation.

#### - Operation sequence in a cycle

##### <1> Cutting with a grinding wheel

By the first depth of cut specified in A, cutting is performed by cutting feed in the X-axis direction. The feedrate specified in I is used.

##### <2> Dwell

A dwell operation is performed for the time specified in U.

##### <3> Grinding

A movement is made by the distance specified in W by cutting feed. Set a grinding axis in parameter No.5176. The feedrate specified in K is used.

##### <4> Cutting with a grinding wheel

By the second depth of cut specified in B, cutting is performed by cutting feed in the X-axis direction. The feedrate specified in I is used.

##### <5> Dwell

A dwell operation is performed for the time specified in U.

##### <6> Grinding (return direction)

A movement is made at the feedrate specified in K in the reverse direction by the distance specified in W.

### Limitation

- **Cutting axis**

As a cutting axis, the first controlled axis is used. By setting bit 0 (FXY) of parameter No. 5101 to 1, the axis can be switched using a plane selection command (G17, G18, or G19).

- **Grinding axis**

Specify a grinding axis by setting an axis number for other than the cutting axis in parameter No. 5176. Specify a grinding command in W without using an axis name. The axis name corresponding to the set axis number can also be used for specification.

- **A, B, W**

The commands of A, B, and W are all incremental commands.

When none of A and B are specified or A=B=0, spark-out operation (execution of only movement in the grinding direction) is performed.

- **H**

When H is not specified or H=0, the specification of H=1 is assumed.

The specification of H is valid only in the block where H is specified.

- **Clear**

The data A, B, W, U, I, and K in the canned cycle is modal information common to G71, G72, G73, and G74. So, the data remains valid until new data is specified. The data is cleared when a G code of group 00 other than G04 or a G code of group 01 other than G71, G72, G73, and G74 is specified. The specification of H is valid only in the block where H is specified.

- **B code**

During the canned cycle, no B code (second auxiliary function) can be specified.

#### NOTE

- 1 If no grinding axis is specified when G71 is specified, alarm PS0455, "ILLEGAL COMMAND IN GRINDING" is issued.
- 2 If the specified cutting axis number and grinding axis number are the same, alarm PS0456, "ILLEGAL PARAMETER IN GRINDING" is issued.
- 3 Even if G90 (absolute command) is specified while this cycle is valid, each of the A, B, and W commands is an incremental command.



## 4.5.2 Traverse Direct Constant-Size Grinding Cycle (G72)

A traverse direct constant-size grinding cycle can be executed.

### Format

**G72 P\_ A\_ B\_ W\_ U\_ I\_ K\_ H\_ ;**

P\_ : Gage number (1 to 4)

A\_ : First depth of cut (The cutting direction depends on the sign.)

B\_ : Second depth of cut (The cutting direction depends on the sign.)

W\_ : Grinding range (The grinding direction depends on the sign.)

U\_ : Dwell time

I\_ : Feedrate for A and B

K\_ : Feedrate for W

H\_ : Repetitive count (from 1 to 9999)

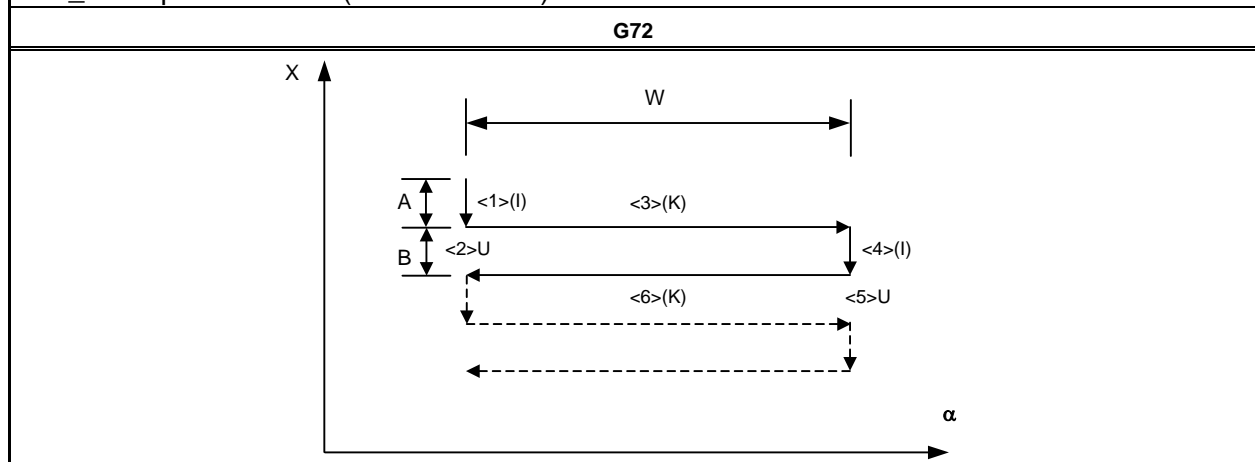

### Explanation

If the multi-step skip option is specified, a gage number can be specified. The method of gage number specification is the same as for the multi-step skip option. If the multi-step skip option is not specified, the conventional skip signal is used.

The commands and operations other than gage number specification are the same as for G71.

#### - Operation performed when the skip signal is input

A G72 cycle can be terminated after interrupting the current operation (or after ending the current operation) by inputting the skip signal during execution of the cycle.

Each operation of the sequence performed when the skip signal is input is described below.

- If the skip signal is input during operation <1> or <4> (movement by A or B), cutting is immediately stopped to return to coordinate  $\alpha$  selected as the cycle start point.

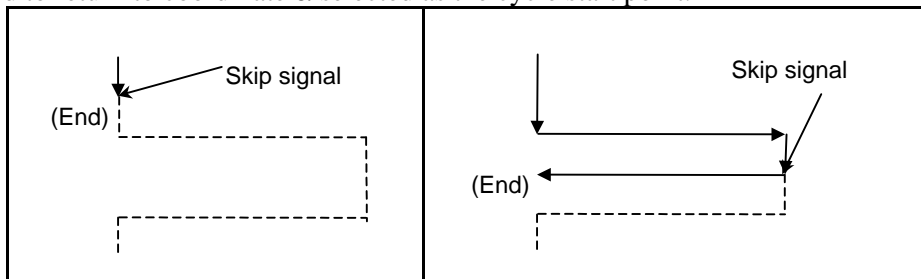

- If the skip signal is input during operation <2> or <5> (dwell), dwell operation is immediately stopped to return to coordinate  $\alpha$  selected as the cycle start point.

- If the skip signal is input during operation <3> or <6> (grinding feed), the tool returns to coordinate  $\alpha$  selected as the cycle start point after the end of movement over W.

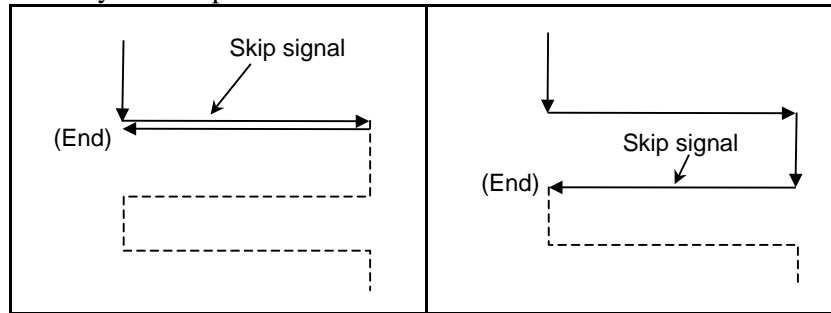

### Limitation

#### - Cutting axis

As a cutting axis, the first controlled axis is used. By setting bit 0 (FXY) of parameter No. 5101 to 1, the axis can be switched using a plane selection command (G17, G18, or G19).

#### - Grinding axis

Specify a grinding axis by setting an axis number for other than the cutting axis in parameter No. 5177. Specify a grinding command in W without using an axis name. The axis name corresponding to the set axis number can also be used for specification.

#### - P

If a value other than P1 to P4 is specified, the skip function is disabled. The specification of P is valid only in the block where P is specified.

#### - A, B, W

The commands of A, B, and W are all incremental commands.

When none of A and B are specified or A=B=0, spark-out operation (execution of only movement in the grinding direction) is performed.

#### - H

When H is not specified or H=0, the specification of H=1 is assumed.

The specification of H is valid only in the block where H is specified.

#### - Clear

The data A, B, W, U, I, and K in the canned cycle is modal information common to G71, G72, G73, and G74. So, the data remains valid until new data is specified. The data is cleared when a G code of group 00 other than G04 or a G code of group 01 other than G71, G72, G73, and G74 is specified. The specification of P or H is valid only in the block where P or H is specified.

#### - B code

During the canned cycle, no B code (second auxiliary function) can be specified.

### NOTE

- 1 If no grinding axis is specified when G72 is specified, alarm PS0455, "ILLEGAL COMMAND IN GRINDING" is issued.
- 2 If the specified cutting axis number and grinding axis number are the same, alarm PS0456, "ILLEGAL PARAMETER IN GRINDING" is issued.
- 3 Even if G90 (absolute command) is specified while this cycle is valid, each of the A, B, and W commands is an incremental command.

**NOTE**

4 If a value from P1 to P4 is specified without specifying the multi-step skip option, alarm PS0370, "G31P/G04Q ERROR" is issued.

### 4.5.3 Oscillation Grinding Cycle (G73)

An oscillation grinding cycle can be executed.

#### Format

**G73 A\_ (B\_) W\_ U\_ K\_ H\_ ;**

A\_ : First depth of cut (The cutting direction depends on the sign.)  
 B\_ : Second depth of cut (The cutting direction depends on the sign.)  
 W\_ : Grinding range (The grinding direction depends on the sign.)  
 U\_ : Dwell time  
 K\_ : Feedrate for W  
 H\_ : Repetitive count (from 1 to 9999)

#### G73

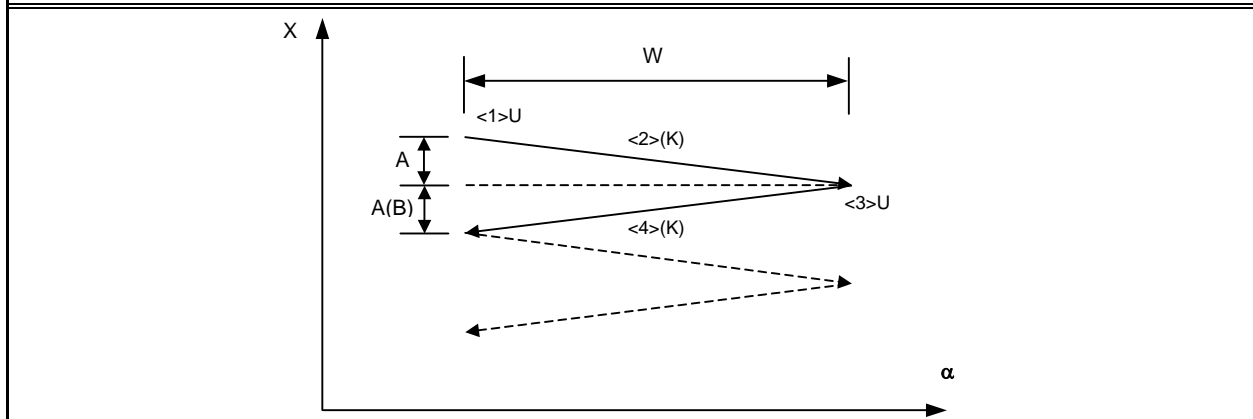

#### Explanation

The oscillation grinding cycle consists of four operations.

The operations from <1> to <4> are repeated until the repetitive count specified in address H is reached. In the case of single block operation, the operations from <1> to <4> are executed with one cycle start operation.

#### - Operation sequence in a cycle

##### <1> Dwell

A dwell operation is performed for the time specified in U.

##### <2> Cutting + grinding with a grinding wheel

Cutting feed is performed on the cutting axis (X-axis) and a grinding axis at the same time. The amount of movement on the cutting axis (depth of cut) is the first depth of cut specified in A, and the amount of movement on a grinding axis is the distance specified in W. Set a grinding axis in parameter No.5178. The feedrate specified in K is used.

##### <3> Dwell

A dwell operation is performed for the time specified in U.

##### <4> Cutting + grinding with a grinding wheel (return direction)

Cutting feed is performed on the cutting axis (X-axis) and a grinding axis at the same time. The amount of movement on the cutting axis (depth of cut) is the second depth of cut specified in B, and the amount of movement on the grinding axis is the distance specified in W. The feedrate specified in K is used.

### Limitation

- **Cutting axis**

As a cutting axis, the first controlled axis is used. By setting bit 0 (FXY) of parameter No. 5101 to 1, the axis can be switched using a plane selection command (G17, G18, or G19).

- **Grinding axis**

Specify a grinding axis by setting an axis number for other than the cutting axis in parameter No. 5178. Specify a grinding command in W without using an axis name. The axis name corresponding to the set axis number can also be used for specification.

- **B**

If B is not specified, B=A is assumed.

The specification of B is valid only in the block where B is specified.

- **A, B, W**

The commands of A, B, and W are all incremental commands.

When none of A and B are specified or A=B=0, spark-out operation (execution of only movement in the grinding direction) is performed.

- **H**

When H is not specified or H=0, the specification of H=1 is assumed.

The specification of H is valid only in the block where H is specified.

- **Clear**

The data A, W, U, and K in the canned cycle is modal information common to G71, G72, G73, and G74. So, the data remains valid until new data is specified. The data is cleared when a G code of group 00 other than G04 or a G code of group 01 other than G71, G72, G73, and G74 is specified. The specification of B or H is valid only in the block where B or H is specified.

- **B code**

During the canned cycle, no B code (second auxiliary function) can be specified.

#### NOTE

- 1 If no grinding axis is specified when G73 is specified, alarm PS0455, "ILLEGAL COMMAND IN GRINDING" is issued.
- 2 If the specified cutting axis number and grinding axis number are the same, alarm PS0456, "ILLEGAL PARAMETER IN GRINDING" is issued.
- 3 Even if G90 (absolute command) is specified while this cycle is valid, each of the A, B, and W commands is an incremental command.

## 4.5.4 Oscillation Direct Constant-Size Grinding Cycle (G74)

An oscillation direct constant-size grinding cycle can be executed.

### Format

**G74 P\_ A\_ (B\_) W\_ U\_ K\_ H\_ ;**

P\_ : Gage number (1 to 4)

A\_ : First depth of cut (The cutting direction depends on the sign.)

B\_ : Second depth of cut (The cutting direction depends on the sign.)

W\_ : Grinding range (The grinding direction depends on the sign.)

U\_ : Dwell time

K\_ : Feedrate for W

H\_ : Repetitive count (from 1 to 9999)

### G74

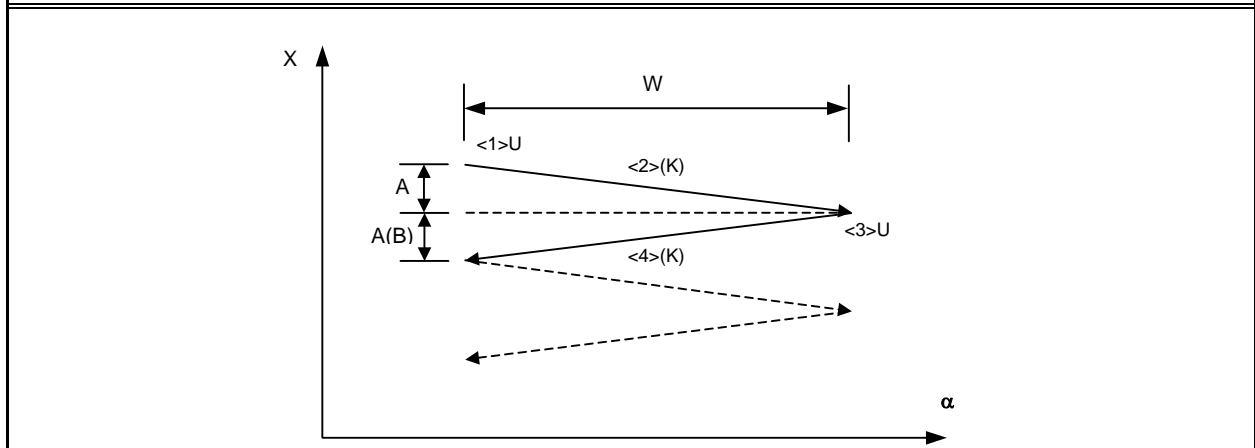

### Explanation

If the multi-step skip option is specified, a gage number can be specified. The method of gage number specification is the same as for the multi-step skip option. If the multi-step skip option is not specified, the conventional skip signal is used.

The commands and operations other than gage number specification are the same as for G73.

#### - Operation performed when the skip signal is input

A G74 cycle can be terminated after interrupting the current operation (or after ending the current operation) by inputting the skip signal during execution of the cycle.

Each operation of the sequence performed when the skip signal is input is described below.

- If the skip signal is input during operation <1> or <3> (dwell), dwell operation is immediately stopped to return to coordinate  $\alpha$  selected as the cycle start point.
- If the skip signal is input during operation <2> or <4> (A, B, grinding feed), the tool returns to coordinate  $\alpha$  selected as the cycle start point after the end of movement over  $W$ .

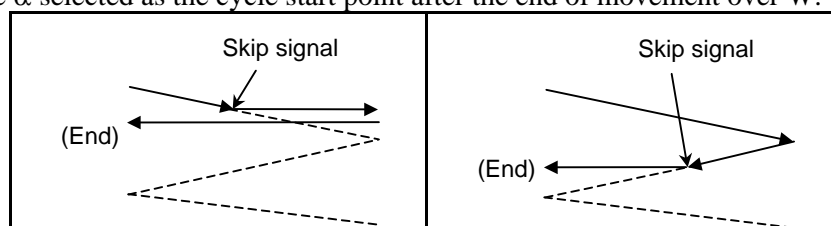

### Limitation

#### - Cutting axis

As a cutting axis, the first controlled axis is used. By setting bit 0 (FXY) of parameter No. 5101 to 1, the axis can be switched using a plane selection command (G17, G18, or G19).

#### - Grinding axis

Specify a grinding axis by setting an axis number for other than the cutting axis in parameter No. 5179. Specify a grinding command in W without using an axis name. The axis name corresponding to the set axis number can also be used for specification.

#### - P

If a value other than P1 to P4 is specified, the skip function is disabled. The specification of P is valid only in the block where P is specified.

#### - B

If B is not specified, B=A is assumed. The specification of B is valid only in the block where B is specified.

#### - A, B, W

The commands of A, B, and W are all incremental commands. When none of A and B are specified or A=B=0, spark-out operation (execution of only movement in the grinding direction) is performed.

#### - H

When H is not specified or H=0, the specification of H=1 is assumed. The specification of H is valid only in the block where H is specified.

#### - Clear

The data A, W, U, and K in the canned cycle is modal information common to G71, G72, G73, and G74. So, the data remains valid until new data is specified. The data is cleared when a G code of group 00 other than G04 or a G code of group 01 other than G71, G72, G73, and G74 is specified. The specification of P, B, or H is valid only in the block where P, B, or H is specified.

#### - B code

During the canned cycle, no B code (second auxiliary function) can be specified.

### NOTE

- 1 If no grinding axis is specified when G74 is specified, alarm PS0455, "ILLEGAL COMMAND IN GRINDING" is issued.
- 2 If the specified cutting axis number and grinding axis number are the same, alarm PS0456, "ILLEGAL PARAMETER IN GRINDING" is issued.
- 3 Even if G90 (absolute command) is specified while this cycle is valid, each of the A, B, and W commands is an incremental command.
- 4 If a value from P1 to P4 is specified without specifying the multi-step skip option, alarm PS0370, "G31P/G04Q ERROR" is issued.

# 4.6 CHAMFERING AND CORNER R

## Overview

A chamfering or corner R block can automatically be inserted between linear interpolation (G01) along a single axis and that along a single axis normal to that single axis. Chamfering or corner R is inserted for a command to move the tool along two axes on the plane determined by the plane selection (G17, G18, or G19) command.

**NOTE**  
When bit 2 (CCR) of parameter No.8134 is 1, this function can be used.

## Format

### - Chamfering

First axis on the selected plane → second axis on the selected plane  
(G17 plane:  $X_P \rightarrow Y_P$ , G18 plane:  $Z_P \rightarrow X_P$ , G19 plane:  $Y_P \rightarrow Z_P$ )

| Format   |  |
|--|--|
| G17 plane: G01 $X_P(U) \_ J(C)\pm l$ ;<br>G18 plane: G01 $Z_P(W) \_ I(C)\pm i$ ;<br>G19 plane: G01 $Y_P(V) \_ K(C)\pm k$ ;   |  |
| Explanation  | Tool movement  |
| <p><math>X_P(U) \_</math><br/><math>Y_P(V) \_</math><br/><math>Z_P(W) \_</math></p> <p>Specifies movement from point a to point b with an absolute or incremental programming in the figure on the right. <math>X_P</math> is the address of the X-axis of the three basic axes or an axis parallel to the X-axis. <math>Y_P</math> is the address of the Y-axis of the three basic axes or an axis parallel to the Y-axis. <math>Z_P</math> is the address of the Z-axis of the three basic axes or an axis parallel to the Z-axis.</p> <p><math>I(C)\pm i</math><br/><math>J(C)\pm j</math><br/><math>K(C)\pm k</math></p> <p>Specify the distance between points b and c in the figure shown at right with a sign following address I, J, K, or C. (Use I, J, or K when bit 4 (CCR) of parameter No. 3405 is set to 0 or C when the bit is set to 1.)</p> | <div style="text-align: center;"> </div> <p>Moves from a to d and c.<br/>(Positive direction along the second axis on the selected plane when a plus sign is specified at I, J, K, or C or negative direction when a minus sign is specified at I, J, K, or C)</p> |

- Chamfering

**Second axis on the selected plane → first axis on the selected plane**  
**(G17 plane:  $Y_P \rightarrow X_P$ , G18 plane:  $X_P \rightarrow Z_P$ , G19 plane:  $Z_P \rightarrow Y_P$ )**

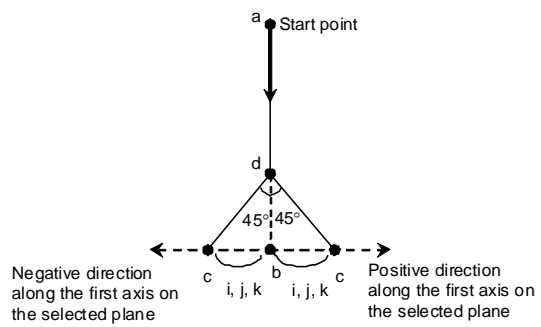
| Format   |   |
|--|---|
| G17 plane: G01 $Y_P(V)_ I(C)\pm i$ ;<br>G18 plane: G01 $X_P(U)_ K(C)\pm k$ ;<br>G19 plane: G01 $Z_P(W)_ J(C)\pm j$ ;   |   |
| Explanation  | Tool movement   |
| <p><math>X_P(U)_</math><br/> <math>Y_P(V)_</math><br/> <math>Z_P(W)_</math></p> <p>Specifies movement from point a to point b with an absolute or incremental programming in the figure on the right. <math>X_P</math> is the address of the X-axis of the three basic axes or an axis parallel to the X-axis. <math>Y_P</math> is the address of the Y-axis of the three basic axes or an axis parallel to the Y-axis. <math>Z_P</math> is the address of the Z-axis of the three basic axes or an axis parallel to the Z-axis.</p> <p><math>I(C)\pm i</math><br/> <math>J(C)\pm j</math><br/> <math>K(C)\pm k</math></p> <p>Specify the distance between points b and c in the figure shown at right with a sign following address I, J, K, or C. (Use I, J, or K when bit 4 (CCR) of parameter No. 3405 is set to 0 or C when the bit is set to 1.)</p> | <p>Moves from a to d and c.</p> <p>(Positive direction along the first axis on the selected plane when a plus sign is specified at I, J, K, or C or negative direction when a minus sign is specified at I, J, K, or C)</p>  |

- Corner R

**First axis on the selected plane → second axis on the selected plane**  
**(G17 plane:  $X_P \rightarrow Y_P$ , G18 plane:  $Z_P \rightarrow X_P$ , G19 plane:  $Y_P \rightarrow Z_P$ )**

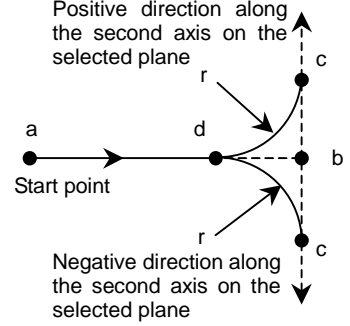
| Format   |  |
|--|--|
| G17 plane: G01 $X_P(U)_ R\pm r$ ;<br>G18 plane: G01 $Z_P(W)_ R\pm r$ ;<br>G19 plane: G01 $Y_P(V)_ R\pm r$ ;  |  |
| Explanation  | Tool movement  |
| <p><math>X_P(U)_</math><br/> <math>Y_P(V)_</math><br/> <math>Z_P(W)_</math></p> <p>Specifies movement from point a to point b with an absolute or incremental programming in the figure on the right. <math>X_P</math> is the address of the X-axis of the three basic axes or an axis parallel to the X-axis. <math>Y_P</math> is the address of the Y-axis of the three basic axes or an axis parallel to the Y-axis. <math>Z_P</math> is the address of the Z-axis of the three basic axes or an axis parallel to the Z-axis.</p> <p><math>R\pm r</math></p> <p>Specify the radius of the arc connecting points d and c in the figure shown at right with a sign following address R.</p> | <p>Moves from a to d and c.</p> <p>(Positive direction along the second axis on the selected plane when +r is specified at R or negative direction when -r is specified at R)</p>  |



- **Corner R****Second axis on the selected plane → first axis on the selected plane****(G17 plane:  $Y_P \rightarrow X_P$ , G18 plane:  $X_P \rightarrow Z_P$ , G19 plane:  $Z_P \rightarrow Y_P$ )**

| Format   |   |
|--|---|
| <b>G17 plane: G01 <math>Y_P(V)_ R\pm r</math>;</b><br><b>G18 plane: G01 <math>X_P(U)_ R\pm r</math>;</b><br><b>G19 plane: G01 <math>Z_P(W)_ R\pm r</math>;</b>   |   |
| Explanation  | Tool movement   |
| <b><math>X_P(U)_</math></b> Specifies movement from point a to point b with an absolute or incremental programming in the figure on the right. $X_P$ is the address of the X-axis of the three basic axes or an axis parallel to the X-axis. $Y_P$ is the address of the Y-axis of the three basic axes or an axis parallel to the Y-axis. $Z_P$ is the address of the Z-axis of the three basic axes or an axis parallel to the Z-axis.<br><br><b><math>R\pm r</math></b> Specify the radius of the arc connecting points d and c in the figure shown at right with a sign following address R. | Moves from a to d and c.<br>(Positive direction along the first axis on the selected plane when +r is specified at R or negative direction when -r is specified at R) |

**Explanation**

By G01 specified for chamfering or corner R, the tool must be moved only along one of the two axes on the selected plane. The command in the next block must move the tool only along the other axis on the selected plane.

Example:

When the A-axis is set as an axis parallel to the basic X-axis (by setting parameter No. 1022 to 5), the following program performs chamfering between cutting feed along the A-axis and that along the Z-axis:

```
G18 A0 Z0
G00 A100.0 Z100.0
G01 A200.0 F100 K30.0
Z200.0
```

The following program causes an alarm. (Because chamfering is specified in the block to move the tool along the X-axis, which is not on the selected plane)

```
G18 A0 Z0
G00 A100.0 Z100.0
G01 X200.0 F100 K30.0
Z200.0
```

The following program also causes an alarm. (Because the block next to the chamfering command moves the tool along the X-axis, which is not on the selected plane)

```
G18 A0 Z0
G00 A100.0 Z100.0
G01 Z200.0 F100 I30.0
X200.0
```

A radius value is specified at I, J, K, R, and C.

In an incremental programming, use point b in the figure in "Format" as the start point in the block next to a chamfering or corner R block. That is, specify the distance from point b. Do not specify the distance from point c.

**Example**

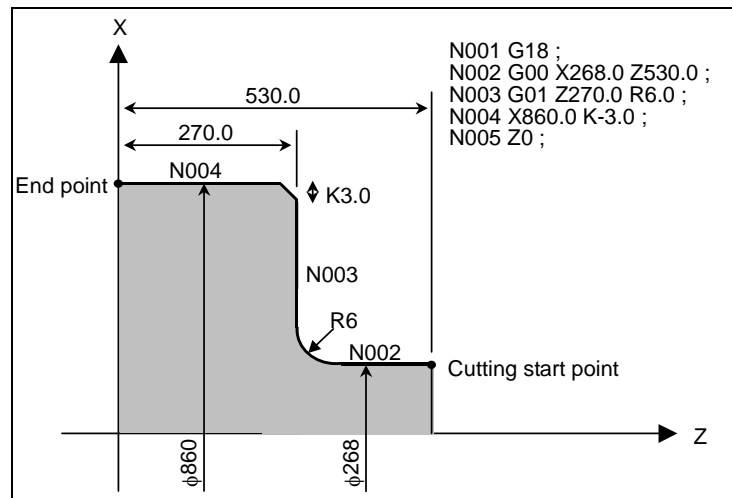

**Limitation**

**- Alarms**

In the following cases, an alarm is issued:

- 1) Chamfering or corner R is specified in a block for threading (alarm PS0050, “CHF/CNR NOT ALLOWED IN THRD BLK”).
- 2) G01 is not specified in the block next to the G01 block in which chamfering or corner R is specified (alarm PS0051, “MISSING MOVE AFTER CNR/CHF” or PS0052, “CODE IS NOT G01 AFTER CHF/CNR”).
- 3) An axis which is not on the selected plane is specified as a move axis in the block in which chamfering or corner R is specified or the next block (alarm PS0051 or PS0052).
- 4) A plane selection command (G17, G18, or G19) is specified in the block next to the block in which chamfering or corner R is specified (alarm PS0051).
- 5) When bit 4 (CCR) of parameter No. 3405 is set to 0 (to specify chamfering at I, J, or K), two or more of I, J, K, and R are specified in G01 (alarm PS0053, “TOO MANY ADDRESS COMMANDS”).
- 6) Chamfering or corner R is specified in the G01 block to move the tool along more than one axis (alarm PS0054, “NO TAPER ALLOWED AFTER CHF/CNR”).
- 7) The travel distance along an axis specified in the block in which chamfering or corner R is specified is smaller than the amount of chamfering or corner R (alarm PS0055, “MISSING MOVE VALUE IN CHF/CNR”). (See the Fig. 4.6 (a).)

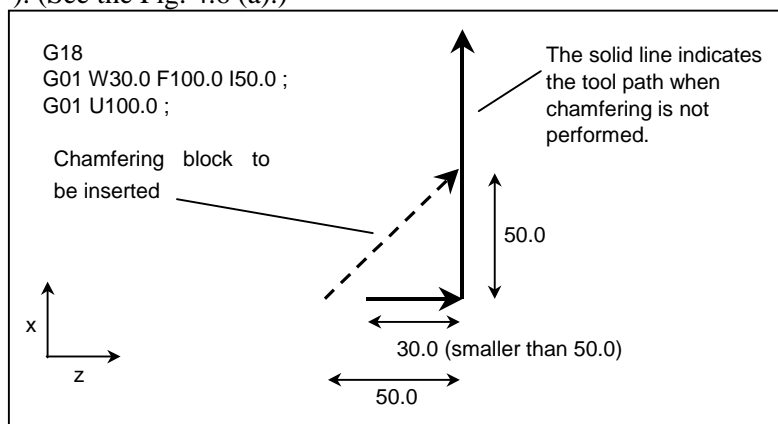

**Fig. 4.6 (a) Example of machining which causes alarm PS0055**

- 8) An invalid combination of a move axis and I, J, or K is specified for chamfering (alarm PS0306, "MISMATCH AXIS WITH CNR/CHF").
- 9) An invalid sign is specified at I, J, K, R, or C (chamfering or corner R in the direction opposite to the movement in the next block is specified) (alarm PS0051). (See the Fig. 4.6 (b).)

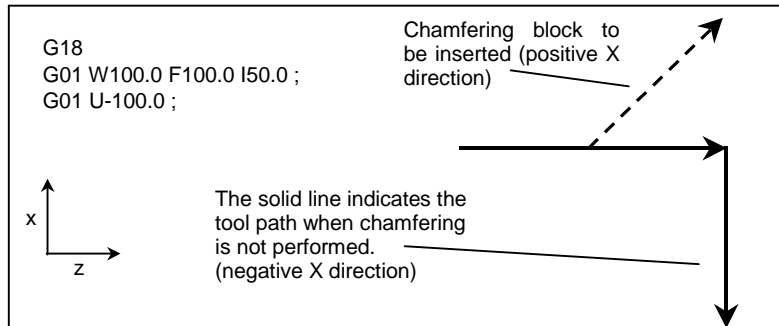

Fig. 4.6 (b) Example of machining which causes alarm PS0051

#### - Single block operation

When the block in which chamfering or corner R is specified is executed in the single block mode, operation continues to the end point of the inserted chamfering or corner R block and the machine stops in the feed hold mode at the end point. When bit 0 (SBC) of parameter No. 5105 is set to 1, the machine stops in the feed hold mode also at the start point of the inserted chamfering or corner R block.

#### - Cutter compensation or tool nose radius compensation

When applying cutter or tool nose radius compensation, note the following points:

1. If the amount of inner chamfering or corner R is too small as compared with compensation and cutting is generated, alarm PS0041, "INTERFERENCE IN CUTTER COMPENSATION" is issued. (See the Fig. 4.6 (c).)

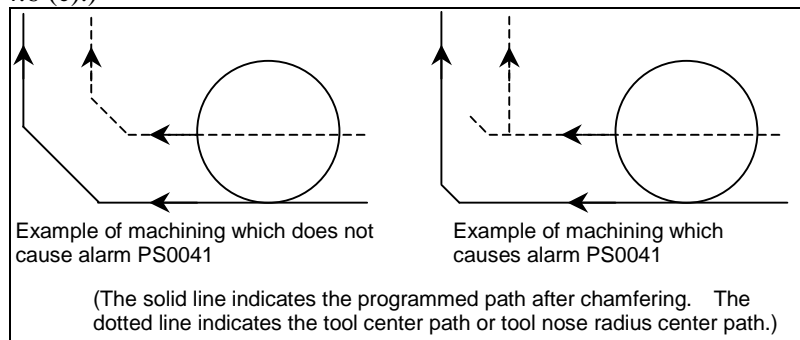

Fig. 4.6 (c)

2. A function is available which intentionally changes the compensation direction by specifying the I, J, or K command in the G01 block in the cutter or tool nose radius compensation mode (see the explanations of cutter or tool nose radius compensation). To use this function when the chamfering and corner R function is enabled (bit 2 (CCR) of parameter No. 8134 is set to 1), set bit 4 (CCR) of parameter No. 3405 to 1 so that the I, J, and K commands are not used as chamfering commands. Operation to be performed under each condition is explained below.

- (1) When the chamfering and corner R function is not used (bit 2 (CCR) of parameter No.8134 = 0)  
In the G01 block in the cutter or tool nose radius compensation mode, the cutter or tool nose radius compensation direction can be specified at address I, J, or K.  
No chamfering is performed.

- (2) When the chamfering and corner R function is used (bit 2 (CCR) of parameter No.8134 = 1)
  - (2-1) When bit 4 (CCR) of parameter No. 3405 is set to 0
    - In the G01 block in the cutter or tool nose radius compensation mode, chamfering can be specified at address I, J, or K. Corner R can also be specified at address R.
    - The cutter or tool nose radius compensation direction cannot be specified.
  - (2-2) When bit 4 (CCR) of parameter No. 3405 is set to 1
    - In the G01 block in the cutter or tool nose radius compensation mode, the cutter or tool nose radius compensation direction can be specified at address I, J, or K.
    - Chamfering or corner R can also be specified at address C or R.

## 4.7 MIRROR IMAGE FOR DOUBLE TURRET (G68, G69)

### Overview

When a unit has a double turret consisting of two tool posts which face each other on the same controlled axis, mirror image can be applied to the X-axis with a G code command. Symmetrical cutting can be performed by creating a machining program for the facing tool posts as if they were in the coordinate system on the same side.

### Format

**G68** : Double turret mirror image on  
**G69** : Mirror image cancel

### Explanation

Mirror image can be applied to the X-axis of the three basic axes that is set by parameter No. 1022 with the G code command.

When G68 is designated, the coordinate system is shifted to the double turret side, and the X-axis sign is reversed from the programmed command to perform symmetrical cutting. This function is called the mirror image for double turret.

To use this function, set the distance between the two tool posts to a parameter No. 1290.

Use this command in the independent block, do not use other commands in the same line.

### Example

- For turning

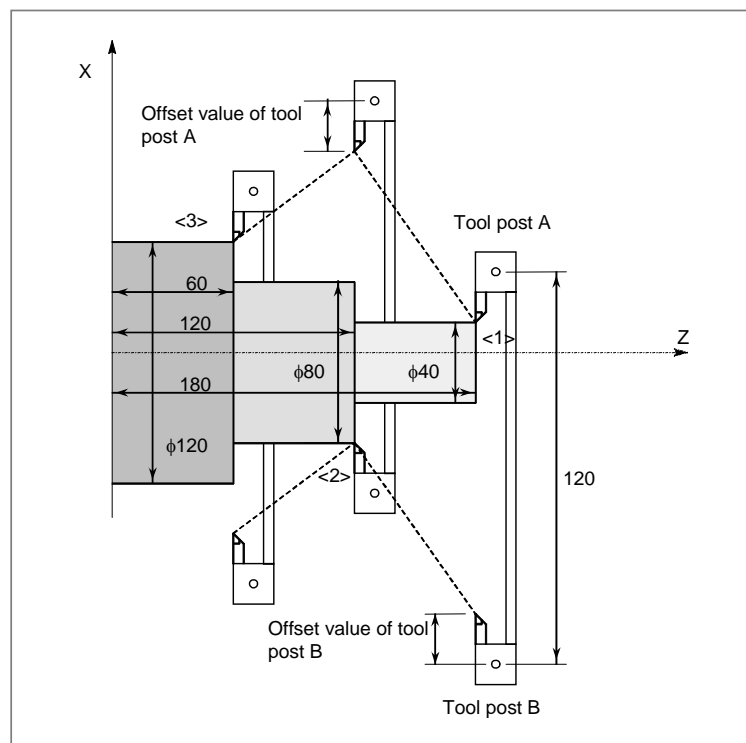

X40.0 Z180.0 T0101 ; Position tool post A at <1>  
G68 ; Shift the coordinate system by the distance A to B (120mm), and turn mirror image on.

X80.0 Z120.0 T0202 ; Position tool post B at <2>  
G69 ; Shift the coordinate system by the distance B to A, and cancel mirror image.

X120.0 Z60.0 T0101 ; Position tool post A at <3>

**NOTE**

A diameter value is specified for the X-axis.

**Limitation**

**NOTE**

- 1 When the G68 command based on this function is enabled, the X-axis coordinate value that can be read with the custom macro system variables #5041 and up or #100101 and up (current specified position (in the workpiece coordinate system)) is a position with mirror image applied.
- 2 This function cannot be used together with the balance cut function. The operation depends on the combination of the systems as follows:

**System in which this function is used**

- One-path system

**System in which this function does not operate**

- System with two paths

## 4.8 DIRECT DRAWING DIMENSION PROGRAMMING

**Overview**

Angles of straight lines, chamfering value, corner R values, and other dimensional values on machining drawings can be programmed by directly inputting these values. In addition, the chamfering and corner R can be inserted between straight lines having an optional angle.

This programming is only valid in memory operation mode.

**NOTE**

When bit 2 (NDD) of parameter No.8137 is 0, this function can be used.

**Format**

Examples of command formats for the G18 plane (ZX plane) are shown. This function can be specified in the following formats also for the G17 plane (XY plane) and G19 plane (YZ plane).

The following formats are changed as follows:

For the G17 plane: Z → X, X → Y

For the G19 plane: Z → Y, X → Z

Table 4.8 (a) Commands table

|   | Commands        | Movement of tool  |
|---|-----------------|---|
| 1 | X2_ (Z2_), A_ ; | <p>The diagram illustrates a 2D coordinate system with a vertical X-axis and a horizontal Z-axis. A point (X2, Z2) is located in the upper-left quadrant, and a point (X1, Z1) is located in the lower-right quadrant. A line segment connects these two points. An angle A is indicated between this line segment and a horizontal line extending from point (X1, Z1) to the right. Arrows on the line segment indicate the direction of tool movement from (X2, Z2) towards (X1, Z1).</p> |

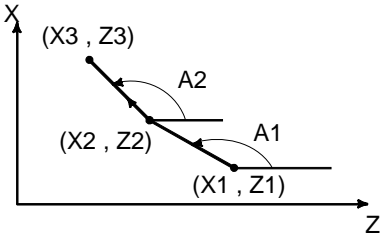
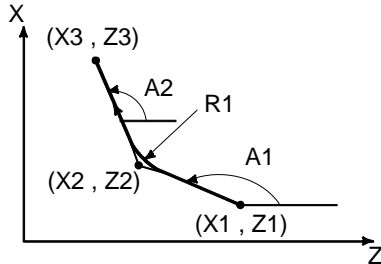
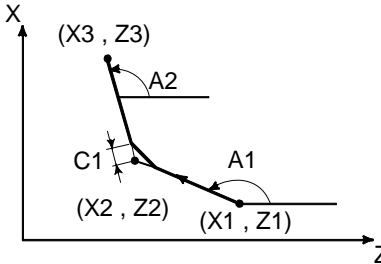
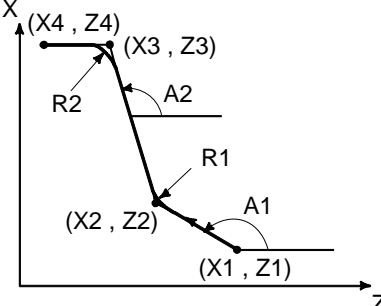
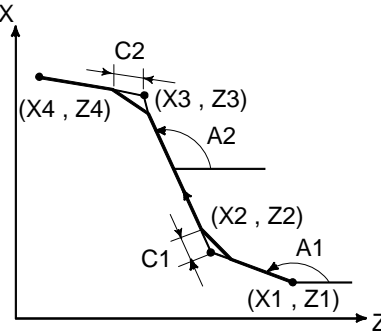
|   | Commands  | Movement of tool   |
|---|---|--|
| 2 | ,A1_ ;<br>X3_ Z3_ , A2_ ;   |  <p>The diagram shows a 2D coordinate system with X and Z axes. A tool path starts at point (X1, Z1), moves to (X2, Z2), and then to (X3, Z3). The angle between the horizontal line at Z2 and the segment (X1, Z1)-(X2, Z2) is labeled A1. The angle between the horizontal line at Z3 and the segment (X2, Z2)-(X3, Z3) is labeled A2.</p>   |
| 3 | X2_ Z2_ , R1_ ;<br>X3_ Z3_ ;<br>or<br>,A1_ , R1_ ;<br>X3_ Z3_ , A2_ ;                                       |  <p>The diagram shows a 2D coordinate system with X and Z axes. A tool path starts at point (X1, Z1), moves to (X2, Z2), and then to (X3, Z3). The angle between the horizontal line at Z2 and the segment (X1, Z1)-(X2, Z2) is labeled A1. The angle between the horizontal line at Z3 and the segment (X2, Z2)-(X3, Z3) is labeled A2. A radius R1 is indicated at the vertex (X2, Z2).</p>  |
| 4 | X2_ Z2_ , C1_ ;<br>X3_ Z3_ ;<br>or<br>,A1_ , C1_ ;<br>X3_ Z3_ , A2_ ;                                       |  <p>The diagram shows a 2D coordinate system with X and Z axes. A tool path starts at point (X1, Z1), moves to (X2, Z2), and then to (X3, Z3). The angle between the horizontal line at Z2 and the segment (X1, Z1)-(X2, Z2) is labeled A1. The angle between the horizontal line at Z3 and the segment (X2, Z2)-(X3, Z3) is labeled A2. A chamfer C1 is indicated at the vertex (X2, Z2).</p>  |
| 5 | X2_ Z2_ , R1_ ;<br>X3_ Z3_ , R2_ ;<br>X4_ Z4_ ;<br>or<br>,A1_ , R1_ ;<br>X3_ Z3_ , A2_ , R2_ ;<br>X4_ Z4_ ; |  <p>The diagram shows a 2D coordinate system with X and Z axes. A tool path starts at point (X1, Z1), moves to (X2, Z2), then to (X3, Z3), and finally to (X4, Z4). The angle between the horizontal line at Z2 and the segment (X1, Z1)-(X2, Z2) is labeled A1. The angle between the horizontal line at Z3 and the segment (X2, Z2)-(X3, Z3) is labeled A2. Radii R1 and R2 are indicated at vertices (X2, Z2) and (X3, Z3) respectively.</p>    |
| 6 | X2_ Z2_ , C1_ ;<br>X3_ Z3_ , C2_ ;<br>X4_ Z4_ ;<br>or<br>,A1_ , R1_ ;<br>X3_ Z3_ , A2_ , C2_ ;<br>X4_ Z4_ ; |  <p>The diagram shows a 2D coordinate system with X and Z axes. A tool path starts at point (X1, Z1), moves to (X2, Z2), then to (X3, Z3), and finally to (X4, Z4). The angle between the horizontal line at Z2 and the segment (X1, Z1)-(X2, Z2) is labeled A1. The angle between the horizontal line at Z3 and the segment (X2, Z2)-(X3, Z3) is labeled A2. Chamfers C1 and C2 are indicated at vertices (X2, Z2) and (X3, Z3) respectively.</p> |

|   | Commands   | Movement of tool |
|---|--|------------------|
| 7 | <pre>X2_Z2_, R1_ ; X3_Z3_, C2_ ; X4_Z4_ ; or ,A1_, R1_ ; X3_Z3_, A2_, C2_ ; X4_Z4_ ;</pre> |                  |
| 8 | <pre>X2_Z2_, C1_ ; X3_Z3_, R2_ ; X4_Z4_ ; or ,A1_, C1_ ; X3_Z3_, A2_, R2_ ; X4_Z4_ ;</pre> |                  |

**Explanation**

A program for machining along the curve shown in Fig. 4.8 (a) is as follows :

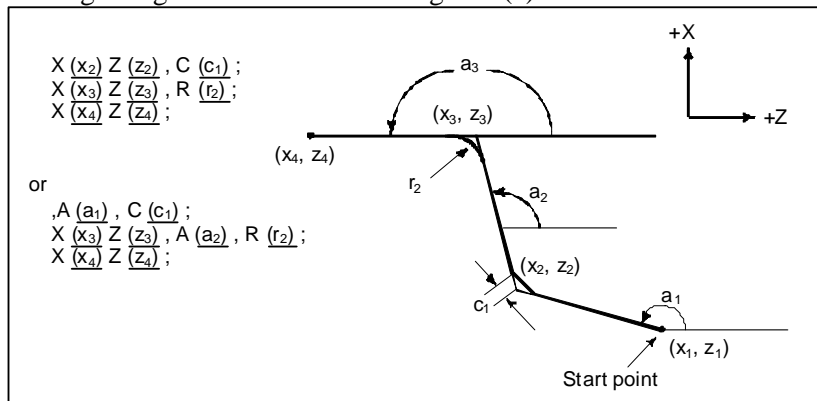

**Fig. 4.8 (a) Machining Drawing (example)**

For command a straight line, specify one or two out of X, Z, and A.

If only one is specified, the straight line must be primarily defined by a command in the next block.

To command the degree of a straight line or the value of chamfering or corner R, command with a comma (,) as follows :

- ,A\_
- ,C\_
- ,R\_

By specifying 1 to bit 4 (CCR) of parameter No.3405 on the system which does not use A or C as an axis name, the degree of a straight line or the value of chamfering or corner R can be commanded without a comma (,) as follows :

- A\_
- C\_
- R\_



**- Command using a supplement**

When bit 5 (DDP) of parameter No. 3405 is set to 1, an angle can be specified using a supplement.

There is the following relationship, assuming that the supplement is  $A'$  and the actual specified angle is  $A$ :

$$A = 180 - A'$$

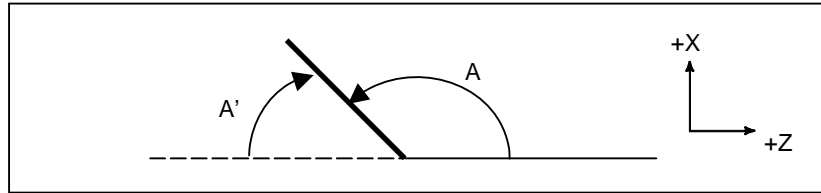

Fig. 4.8 (b) Supplement

**Limitation****NOTE**

- 1 Direct drawing dimension programming commands are valid only during memory operation.
- 2 The following G codes are not applicable to the same block as commanded by direct input of drawing dimensions or between blocks of direct input of drawing dimensions which define sequential figures.
  - (a) G codes other than G04 in group 00
  - (b) G codes other than G00, G01, and G33 in group 01
  - (c) G codes in group 10 (canned cycle for drilling)
  - (d) G codes in group 16 (plane selection)
  - (e) G22 and G23
- 3 Corner R cannot be inserted into a threading block.
- 4 When the chamfering and corner R function is enabled (bit 2 (CCR) of parameter No. 8134 is set to 1), both functions cannot be used simultaneously. When bit 0 (CRD) of parameter No. 3453 is set to 1, direct drawing dimension programming is enabled. (At this time, chamfering and corner R are disabled.)
- 5 When the end point of the previous block is determined in the next block according to sequential commands of direct drawing dimension programming during single block operation, the machine does not stop in the single block stop mode, but stop in the feed hold stop mode at the end point of the previous block.
- 6 The angle allowance in calculating the point of intersection in the program below is  $\pm 1^\circ$ .  
(Because the travel distance to be obtained in this calculation is too large.)
  - (a)  $X\_ , A\_ ;$  (If a value within  $0^\circ \pm 1^\circ$  or  $180^\circ \pm 1^\circ$  is specified for the angle instruction A, the alarm PS0057, "NO SOLUTION OF BLOCK END" occurs.)
  - (b)  $Z\_ , A\_ ;$  (If a value within  $90^\circ \pm 1^\circ$  or  $270^\circ \pm 1^\circ$  is specified for the angle instruction A, the alarm PS0057 occurs.)
- 7 An alarm PS0058, "END POINT NOT FOUND" occurs if the angle made by the 2 lines is within  $\pm 1^\circ$  when calculating the point of intersection.
- 8 Chamfering or corner R is ignored if the angle made by the 2 lines is within  $\pm 1^\circ$ .

**NOTE**

- 9 Both a dimensional command (absolute programming) and angle instruction must be specified in the block following a block in which only the angle instruction is specified.

(Example)

N1 X\_ ,A\_ ,R\_ ;

N2 ,A\_ ;

N3 X\_ Z\_ ,A\_ ;

In addition to the dimensional command, angle command must be specified in block N3. If the angle command is not specified, alarm PS0056, "NO END POINT & ANGLE IN CHF/CNR" is issued. If the coordinates are not specified with an absolute programming, alarm PS0312, "ILLEGAL COMMAND IN DIRECT DRAWING DIMENSIONS PROGRAMMING" is issued.

- 10 In the tool nose radius compensation mode, a block in which only the angle command is specified in direct drawing dimension programming is assumed to be a block with no move command. For details of compensation when sequential blocks with no move command are specified, see the explanation of tool nose radius compensation.
- 11 If two or more blocks with no move command are specified between sequential commands of direct drawing dimension programming, alarm PS0312 is issued.
- 12 When bit 4 (CCR) of parameter No. 3405 is set to 1, address A in the G76 (multiple threading cycle) block specifies the tool nose angle. When A or C is used as an axis name, it cannot be used in the angle or chamfering command in direct drawing dimension programming. Use ,A\_ or ,C\_ (when bit 4 (CCR) of parameter No. 3405 is set to 0).
- 13 In a multiple repetitive canned cycle, in blocks with sequence numbers between those specified at P and Q, a program using direct drawing dimension programming can be used. The block with the last sequence number specified at Q must not be an intermediate block of these specified blocks.
- 14 If a minus value is commanded as a chamfering value / corner R value, alarm PS0055, "MISSING MOVE VALUE IN CHF/CNR" is issued. When bit 7 (CRC) of parameter No. 3458 is set to 1, alarm is not issued even if a minus value is commanded as a chamfering value / corner R value and a minus value is converted to a plus value.

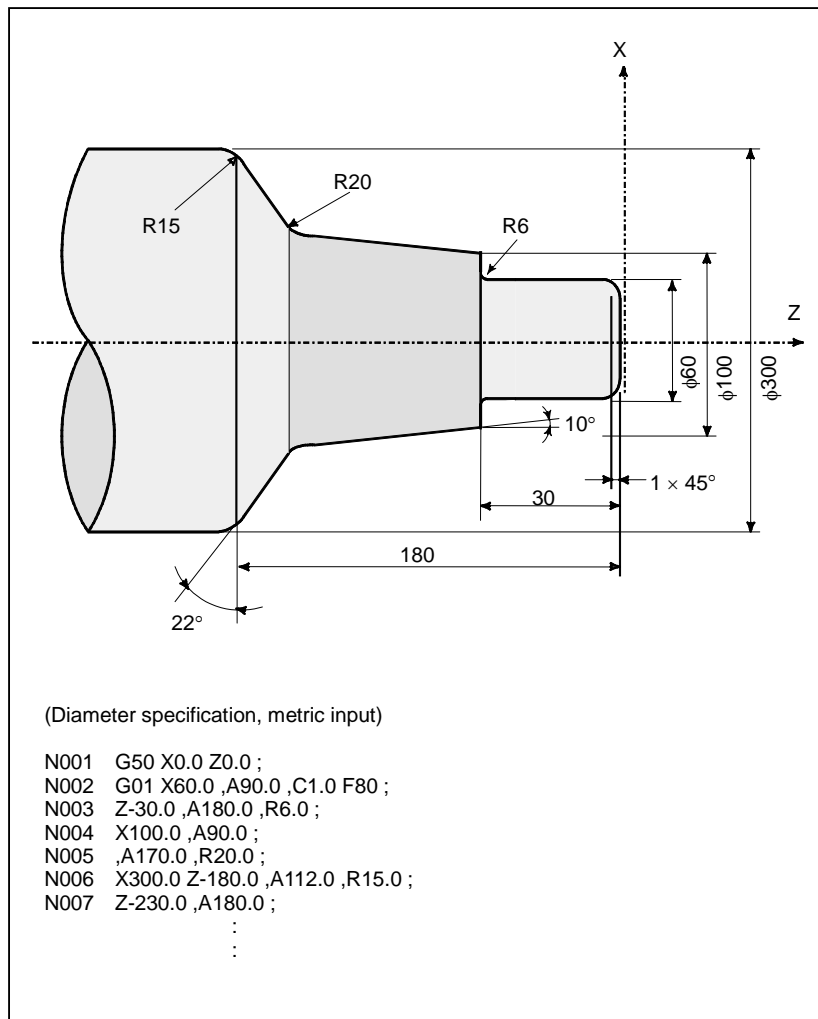
**Example**

# 5 COMPENSATION FUNCTION

Chapter 5, "COMPENSATION FUNCTION", consists of the following sections:

|     |  |     |
|-----|--|-----|
| 5.1 | TOOL OFFSET.....   | 142 |
| 5.2 | OVERVIEW OF TOOL NOSE RADIUS COMPENSATION (G40-G42)..... | 153 |
| 5.3 | OVERVIEW OF CUTTER COMPENSATION (G40-G42).....           | 165 |
| 5.4 | DETAILS OF CUTTER OR TOOL NOSE RADIUS COMPENSATION.....  | 171 |
| 5.5 | VECTOR RETENTION (G38).....                              | 222 |
| 5.6 | CORNER CIRCULAR INTERPOLATION (G39).....                 | 223 |
| 5.7 | EXTENDED TOOL SELECTION.....                             | 225 |
| 5.8 | AUTOMATIC TOOL OFFSET (G36, G37).....                    | 228 |

## 5.1 TOOL OFFSET

Tool offset is used to compensate for the difference when the tool actually used differs from the imagined tool used in programming (usually, standard tool). Tool nose moves on the programmed path by this compensation.

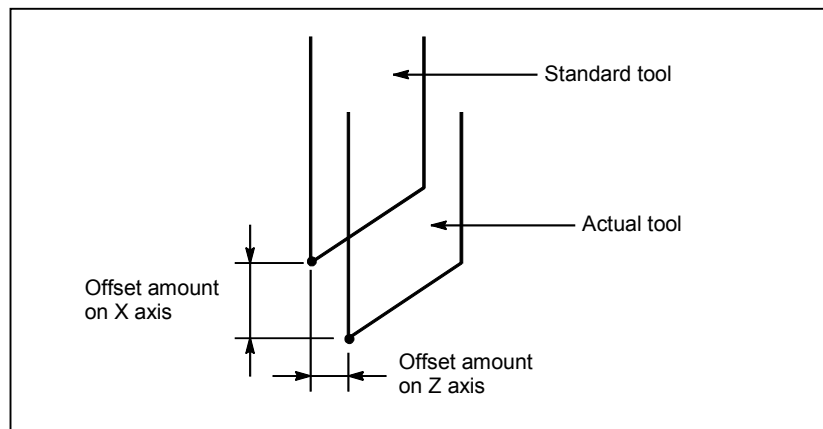

Fig. 5.1 (a) Tool offset

### 5.1.1 Tool Geometry Offset and Tool Wear Offset

Tool geometry offset and tool wear offset are possible to divide the tool offset to the tool geometry offset for compensating the tool shape or tool mounting position and the tool wear offset for compensating the tool nose wear. The tool geometry offset value and tool wear offset value can be set individually. When these values are not distinguished from each other, the total of the values is set as the tool offset value.

#### NOTE

Tool geometry offset and tool wear offset are valid, when the bit 6 (NGW) of parameter No. 8136 is 0.

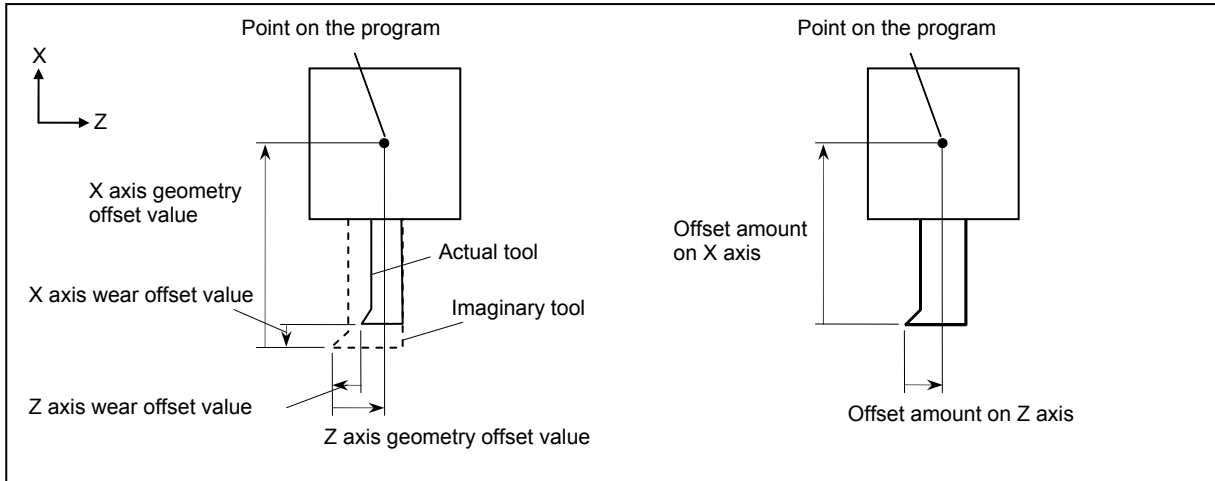

**Fig. 5.1.1 (a) If tool geometry offset and tool wear offset are distinguished from each other (left) and if they are not (right)**

Set the distance from tool nose to the point on the program ( tool nose of standard tool, or tool mounting position ) to a tool geometry offset value.

Generally, a sign of tool wear offset value is the opposite to a sign of tool geometry offset value. In the example of the above figure, the geometry offset value is a positive and the wear offset value is a negative.

### 5.1.2 T Code for Tool Offset

#### Format

Select a tool with a numeric value after a T code. A part of the numeric value is used as a tool offset number for specifying data such as a tool offset value. The following selections can be made according to the specification method and parameter setting:

| Meaning of T code (*1)  |  | Parameter setting for specifying of offset No. (*2)   |
|---|--|---|
| Bit 1 (LGN) of parameter No. 5002=0   | Bit 1 (LGN) of parameter No. 5002=1  |   |
| T xxxxxxx y<br>xxxxxxx : Tool selection<br>y : Tool wear and tool geometry offset | T xxxxxxx y<br>xxxxxxx : Tool selection and tool geometry offset<br>y : Tool wear offset | A tool wear offset number is specified using the lower one digit of a T code.<br>When parameter No. 5028 is set to 1    |
| T xxxxxx yy<br>xxxxxx : Tool selection<br>yy : Tool wear and tool geometry offset | T xxxxxx yy<br>xxxxxx : Tool selection and tool geometry offset<br>yy : Tool wear offset | A tool wear offset number is specified using the lower two digits of a T code.<br>When parameter No. 5028 is set to 2   |
| T xxxxx yyy<br>xxxxx : Tool selection<br>yyy : Tool wear and tool geometry offset | T xxxxx yyy<br>xxxxx : Tool selection and tool geometry offset<br>yyy : Tool wear offset | A tool wear offset number is specified using the lower three digits of a T code.<br>When parameter No. 5028 is set to 3 |

\*1 The maximum number of digits of a T code can be specified using parameter No. 3032. (1 to 8 digits)

\*2 When parameter No. 5028 is set to 0, the number of digits of a T code used for offset number specification depends on the number of tool offsets.

Example)

When the number of tool offsets is 1 to 9: Lower one digit

When the number of tool offsets is 10 to 99: Lower two digits

When the number of tool offsets is 100 to 999: Lower three digits

### 5.1.3 Tool Selection

Tool selection is made by specifying the T code corresponding to the tool number. Refer to the machine tool builder's manual for the relationship between the tool selection number and the tool.

### 5.1.4 Offset Number

Tool offset number has two meanings. It specifies the offset distance corresponding to the number that is selected to begin the offset function. A tool offset number of 0 indicates that the offset amount is 0 and the offset is cancelled.

### 5.1.5 Offset

#### Explanation

##### - Offset methods

Two methods are available to geometry offset and wear compensation, offset with tool movement and compensation with coordinate shift. Which offset method to select can be specified with bit 2 (LWT) and bit 4 (LGT) of parameter No. 5002. When tool geometry and wear compensation is disabled (bit 6 (NGW) of parameter No. 8136 is set to 1), offset with tool movement is assumed unconditionally.

| Bit 6(NGW) of No.8136 | Compensation element                | Parameter        |                  |                |                  |
|-----------------------|-------------------------------------|------------------|------------------|----------------|------------------|
|                       |                                     | LWT=0<br>LGT=0   | LWT=1<br>LGT=0   | LWT=0<br>LGT=1 | LWT=1<br>LGT=1   |
| 1                     | Wear and geometry not distinguished | Tool movement    |                  |                |                  |
| 0                     | Wear compensation                   | Tool movement    | Coordinate shift | Tool movement  | Coordinate shift |
|                       | Geometry compensation               | Coordinate shift | Coordinate shift | Tool movement  | Tool movement    |

##### - Offset with tool movement

The tool path is offset by the X, Y, and Z tool offset values for the programmed path. The tool offset distance corresponding to the number specified by the T code is added to or subtracted from the end position of each programmed block.

The vector with tool offset X, Y, and Z is called the offset vector. Offset is the same as the offset vector.

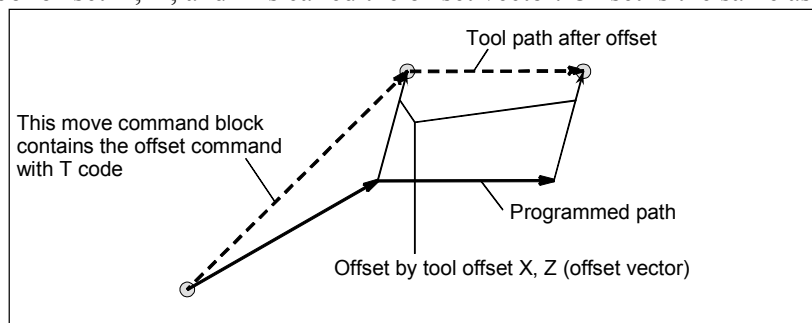

Offset operation with tool movement

#### NOTE

- When G50 X\_Z\_T\_ ; is specified, the tool is not moved. The coordinate system in which the coordinate value of the tool position (X,Z) is set. The tool position is obtained by subtracting the offset value corresponding to the tool offset number specified in the T code.

**NOTE**

2 The G codes in the 00 group other than G50 must not be specified in the same block as that containing a T code. If one of G28, G29, G30, and G53 is specified in the same block as that containing a T code, alarm PS0245, "T-CODE NOT ALLOWED IN THIS BLOCK", is issued.

**- Offset with coordinate shift**

The workpiece coordinate system is shifted by the X, Y, and Z tool offset amounts. Namely, the offset amount corresponding to the number designated with the T code is added to or subtracted from the absolute coordinates.

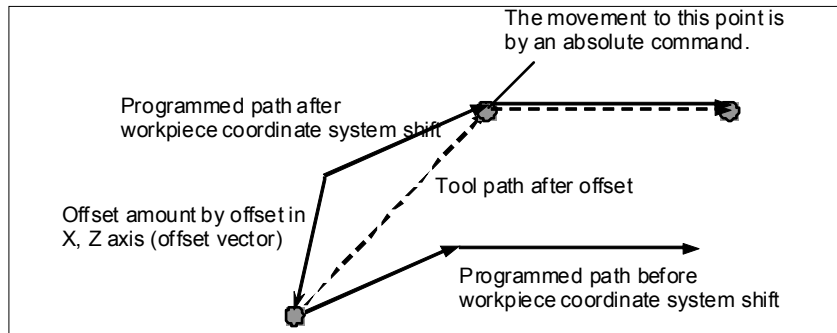

Offset operation with coordinate shift

**- Starting and canceling offset by specifying a T code**

Specifying a tool offset number with a T code means to select the tool offset value corresponding to it and to start offset. Specifying 0 as a tool offset number means to cancel offset.

For offset with tool movement, whether to start or cancel the offset can be specified with bit 6 (LWN) of parameter No. 5002. For compensation with coordinate shift, the offset is started and canceled when a T code is specified. For the cancellation of geometry compensation, its operation can be selected with bit 5 (LGC) of parameter No. 5002.

| Offset method    | Bit 6 (LWM) of parameter No. 5002=0  | Bit 6 (LWM) of parameter No. 5002=1 |
|------------------|--|-------------------------------------|
| Tool movement    | When a T code is specified   | When an axial movement is specified |
| Coordinate shift | When a T code is specified<br>(Note that geometry offset can be canceled only if bit 5 (LGC) of parameter No. 5002 = 1.) |                                     |

**- Canceling offset with reset**

Tool offset is canceled under one of the following conditions:

- <1> The power to the CNC is turned off and turned back on
- <2> The reset button on the MDI unit is pressed
- <3> A reset signal is input from the machine to the CNC

In cases <2> and <3> above, it is possible to select a cancel operation using bit 3 (LVC) of parameter No. 5006 and bit 7 (TGC) of parameter No. 5003.

| Offset method    |                 | Parameter      |   |                |   |
|------------------|-----------------|----------------|---|----------------|---|
|                  |                 | LVC=0<br>TGC=0 | LVC=1<br>TGC=0                                  | LVC=0<br>TGC=1 | LVC=1<br>TGC=1                                  |
| Tool movement    | Wear offset     | Not canceled.  | Canceled.<br>(When axial movement is specified) | Not canceled.  | Canceled.<br>(When axial movement is specified) |
|                  | Geometry offset |                |   |                |   |
| Coordinate shift | Wear offset     | Not canceled.  | Canceled.                                       | Not canceled.  | Canceled.                                       |
|                  | Geometry offset | Not canceled.  | Not canceled.                                   | Canceled.      | Canceled.                                       |

**Example**

N1 X60.0 Z50.0 T0202 ;      Creates the offset vector corresponding to tool offset number 02.  
 N2 Z100.0 ;  
 N3 X200.0 Z150.0 T0200 ;      Cancels the offset vector with offset number 0.

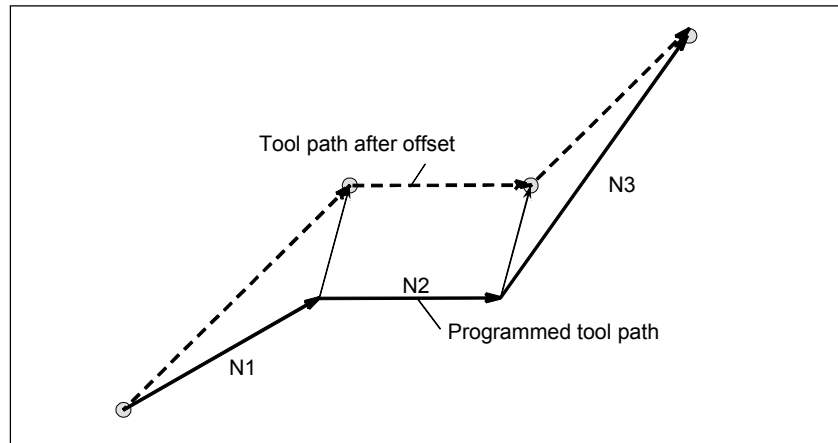
**Limitation**

- **Helical interpolation (G02, G03)**

Tool offset cannot be specified in a block in which helical interpolation is used.

- **Thread cutting (G32,G34,G35,G36)**

Tool offset cannot be specified in a block in which thread cutting is specified. If tool offset is specified, alarm PS0509, "TOOL OFFSET COMMAND IS NOT AVAILABLE", is issued.

- **Coordinate system rotation (G68.1)**

Coordinate system rotation is executed on the command program first, followed by tool offset.

- **3-dimensional coordinate conversion (G68.1)**

If tool offset is used, tool offset with coordinate shift cannot be used. Offset with tool movement must be specified inside a nest of 3-dimensional coordinate conversion. At the beginning block of the 3-dimensional coordinate conversion, tool does not move for a converted tool offset value.

Example) G68.1 ... ;  
 T0101;  
 ;  
 T0100;  
 G69.1 ... ;

- **Workpiece coordinate system preset (G50.3)**

When the bit 7(WTC) of parameter No.1205 is 0, performing workpiece coordinate system preset causes tool offset with tool movement to be canceled; this does not cause tool offset with coordinate shift to be canceled.

When the bit 7(WTC) of parameter No.1205 is 1, performing workpiece coordinate system preset does not cause neither tool position offset with tool movement nor tool position offset with coordinate shift to be canceled.



- **Machine coordinate system setting (G53), reference position return (G28), second, third, and fourth reference position return (G30), and manual reference position return**

Basically, before performing these commands or operations, cancel tool offset. These operations do not cause tool offset to be canceled. The following actions take place:

|                  | When the command or operation is specified                    | When the next axial movement command is specified             |
|------------------|---|---|
| Tool movement    | The tool offset value is temporarily canceled.                | The tool offset value is reflected.                           |
| Coordinate shift | Coordinates with the tool offset value reflected are assumed. | Coordinates with the tool offset value reflected are assumed. |

- **Offset command in the coordinate system rotation or programmable mirror image mode**

If tool offset is specified when offset with coordinate system shift is enabled (when bit 2 (LWT) of parameter No. 5002 is set to 1 or bit 4 (LGT) of parameter No. 5002 is set to 0) in the coordinate system rotation or programmable mirror image mode, alarm PS0509 is issued. The same alarm is issued when bit 6 (EVO) of parameter No. 5001 is set to 1 and the offset amount is changed.

- **Auxiliary function output in moving axis (G50.9)**

The alarm PS5330, "G50.9 FORMAT ERROR" is issued when a T-code and auxiliary function output in moving axis (G50.9) are specified in the same block.

- **Programmable parameter input (G10)**

The alarm PS1144, "G10 FORMAT ERROR" is issued when a T-code is specified during programmable parameter input.

## 5.1.6 Y-Axis Offset

### Overview

When the Y axis, one of the basic three axes, is used with a lathe system, this function performs Y axis offset.

If the tool geometry and wear offset options are valid (the bit 6 (NGW) of parameter No. 8136 is 0), the both tool geometry offset and tool wear offset are effective to Y-axis offset.

#### NOTE

When bit 1 (YOF) of parameter No.8132 is 1, this function can be used.

### Explanation

Y axis offset results in the same operation as tool offset. For an explanation of the operation, related parameters, and the like, refer to the item "Tool Offset."

#### 5.1.6.1 Support of arbitrary axes for Y axis offset

### Overview

In a lath system, Y axis offset has been usable with the basic three axes only. This function enables Y axis offset to be used with arbitrary axes other than the Y axis, which is one of the basic three axes.

## 5.1.7 2nd Geometry Tool Offset

### Overview

To compensate for a difference in tool attachment position or selection position, this function adds second geometry tool offset to the X axis, Y axis, and Z axis with all paths.

In contrast to this offset, the ordinary tool geometry offset is called the first geometry tool offset.

It is possible to apply a tool offset value (tool wear offset + tool geometry offset) in the reverse direction, using an appropriate signal.

This function may be used if the offset value differs even with a single tool for a mechanical reason depending on the mounting position (inside/outside) or the selected position (right/left).

### NOTE

- 1 This function is an optional function.  
To use this function, this option and "Tool geometry offset and Tool wear offset" are required. "Tool geometry offset and Tool wear offset" can be used, when bit 6 (NGW) of parameter No.8136 is 0.
- 2 When the "Y-axis offset" is enabled (bit 1 (YOF) of parameter No.8132 is 1), the "2nd Geometry tool offset" for Y axis can be used.

### Format

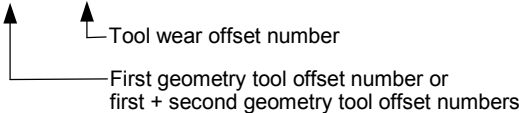
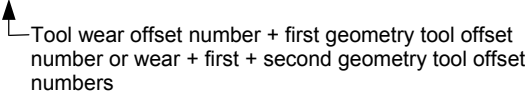
- If bit 1 (LGN) of parameter No. 5002 = 1  
**M** ○ ○ (M code that enables second geometry tool offset) ;  
**T** ○ ○ ○ ○ ○ ○ ;  

- If bit 1 (LGN) of parameter No. 5002 = 0  
**M** ○ ○ (M code that enables second geometry tool offset) ;  
**T** ○ ○ ○ ○ ○ ○ ;  

### Explanation

#### - Specification method

Offset using the second geometry tool offset is performed with a program command.

Specify the second geometry tool offset with a T code command, and using the second geometry tool offset signal G2SLC, specify whether to set the offset value of the specified tool geometry offset number to the first geometry tool offset only or to the first geometry tool offset plus the second geometry tool offset. If using the first geometry tool offset plus the second geometry tool offset, specify the axis to which the second geometry tool offset is to be applied, using the appropriate one of the second geometry tool offset axis select signal G2X, G2Z, and G2Y.

Generally, before a T code command, specify the M code to enable the second geometry tool offset. For details, refer to the manual supplied by the machine tool builder. The same number as the first geometry tool offset number is always selected as the second geometry tool offset number.

During execution, the tool offset value for each axis is either of the following:

- First geometry tool offset value + tool wear offset value
- First geometry tool offset value + second geometry tool offset value + tool wear offset value

## Example)

- The code is a 4-digit code. (The number of digits of a T code is specified with parameter No. 3032.)
- The offset type is tool movement (bit 4 (LGT) of parameter No. 5002 = 1).
- The lower two digits of the T code is the tool geometry offset number (parameter No. 5028 = 2).
- Offset is performed when the T code block is executed (bit 6 (LWM) of parameter No. 5002 = 0).
- The X axis data for first geometry tool offset number 1 is 1.000.
- The X axis data for second geometry tool offset number 1 is 10.000.
- The tool geometry offset number is specified with the tool selection number (bit 1 (LGN) of parameter No. 5002 = 1).
- Signals G2SLC = '1', G2X = '1', and G2Z = G2Y = '0'

If T0102 is specified under the above conditions, the upper two digits 01 of the T code cause the first and second geometry tool offset numbers 1 to be selected, so that the absolute and machine coordinates will be 11.000 on the X axis only.

- **Offset data**

The data for the second geometry tool offset can be set for each path. The number of items of the data can be set with parameter No. 5024. The data remains stored even after the power is turned off.

If the data is to be made common to paths, use the common memory between each path.

**Example**

Fig. 5.1.7 (a) Example of the application of the second geometry tool offset

In the machine configuration shown in the Fig. 5.1.7 (a), for the offset data for the tool mounted to the first path (standard turret), set the offset data of the tool itself as the first geometry tool offset data. (The second geometry tool offset data is 0.) For the offset data for the tool mounted to the second path (linear turret), set the offset data of the tool itself as the first geometry tool offset data and the offset data from the workpiece origin at the mounting position as the second geometry tool offset data. Usually, the offset data of the tool itself is measured separately from the offset data at the mounting position, these data can be set separately by using the second geometry tool offset.

| First geometry tool offset |         |        | Second geometry tool offset |         |          |
|----------------------------|---------|--------|-----------------------------|---------|----------|
| No.                        | X axis  | Z axis | No.                         | X axis  | Z axis   |
| 01                         | 20.000  | 5.000  | 01                          | 0.000   | 0.000    |
| :                          | :       | :      | :                           | :       | :        |
| 10                         | 25.000  | 8.000  | 10                          | 0.000   | 0.000    |
| 11                         | -20.000 | 5.000  | 11                          | 120.000 | 10.000   |
| 12                         | -10.000 | 3.000  | 12                          | 120.000 | -30.000  |
| 13                         | -15.000 | 0.000  | 13                          | 120.000 | -70.000  |
| :                          | :       | :      | :                           | :       | :        |
| 16                         | -18.000 | 7.000  | 16                          | 120.000 | -190.000 |

## 5.1.8 4th/5th Axis Offset

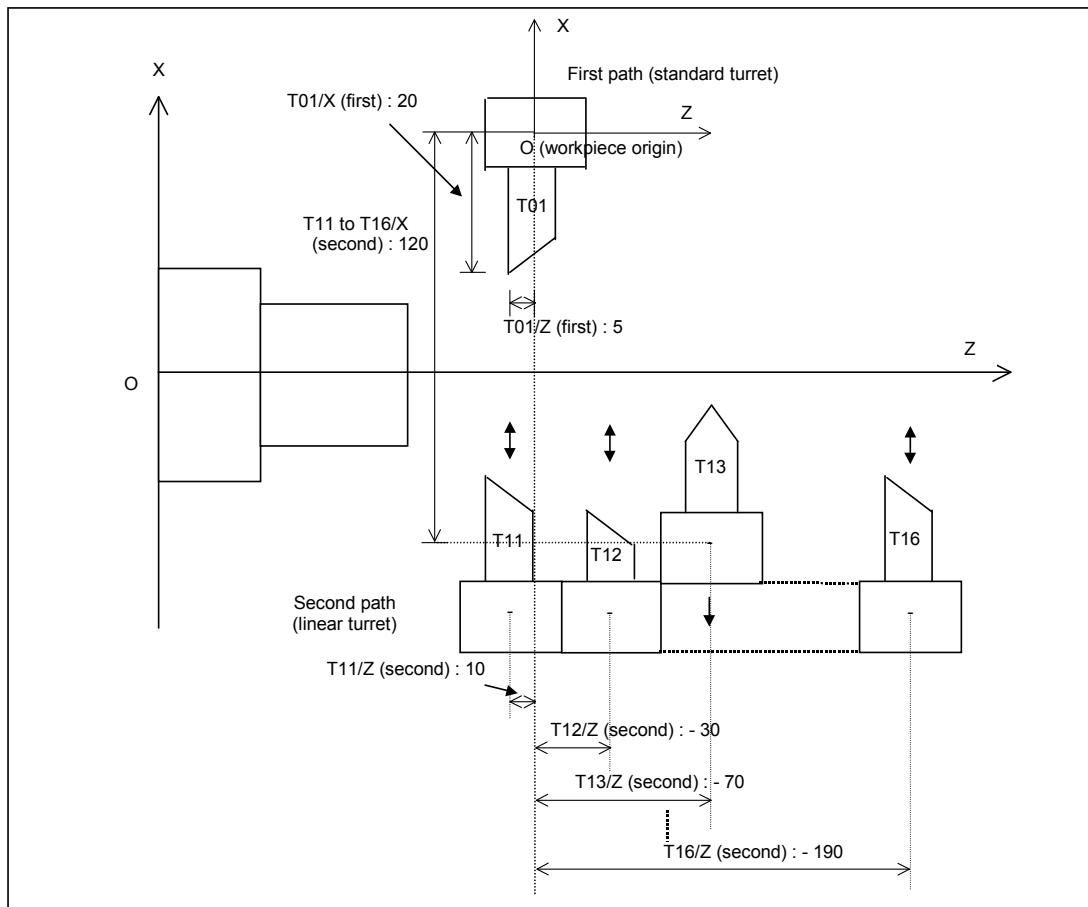
### Overview

This function enables tool offset for the 4th axis and 5th axis following the basic three axes (X, Y, and Z axes). As with tool offsets based on the basic three axes (X, Y, and Z axes), 128 sets of 4th/5th axis tool offsets are available. By setting bit 6(NGW) of parameter No.8136 to 0, tool geometry offset and tool wear offset are enabled. Moreover, the number of sets can be increased from 128 to 200 by specifying an option.

A tool offset value can be applied to arbitrary axes by setting an axis number (1 to the maximum number of controlled axes) to be used for 4th axis offset in parameter No. 5044 and setting an axis number (1 to the maximum number of controlled axes) to be used for 5th axis offset in parameter No. 5045. By setting bit 1 (NO5) of parameter No. 11400 to 1, 5th axis offset is enabled.

If the same axis as used with the Y axis offset function is specified, however, a Y axis offset value is applied to the specified axis, and a 4th axis offset value or 5th axis offset value is invalidated.

Tool offset values can be input through an I/O device.

#### NOTE

This function is an optional function.

### Explanation

The operation of 4th/5th axis offset is the same as the operation of tool offset. For the operation, see Section 5.1, "TOOL OFFSET".

### Setting of tool offset values with the G10 command

By programming, 4th/5th axis offset values can be input.

**Format**

**G10 P\_X\_Y\_Z\_R\_Q\_E\_F\_;**

**or**

**G10 P\_U\_V\_W\_C\_Q\_E\_F\_;**

P : Offset number

0 : Specifies a workpiece coordinate system shift value.

1 to 200 : Specifies a tool wear offset value.

10000+(1 to 200) : Specifies a tool geometry offset value, with a number (1 to 200) representing an offset number.

X : X axis offset value (absolute)

Y : Y axis offset value (absolute)

Z : Z axis offset value (absolute)

U : X axis offset value (incremental)

V : Y axis offset value (incremental)

W : Z axis offset value (incremental)

R : Tool nose radius compensation value (absolute)

C : Tool nose radius compensation value (incremental)

Q : Virtual tool nose number

E : 4th axis offset value (absolute)

F : 5th axis offset value (absolute)

**- Explanation**

As in the G10 format above, address E for inputting a 4th axis offset value and address F for inputting a 5th axis offset value allow absolute values only to be input.

**NOTE**

- 1 When compared with the conventional G10 format for changing tool offset values, address E for specifying a 4th axis offset value and address F for specifying a 5th axis offset value are newly added in the format above.
- 2 When a program based on the G10 format above is executed, only those offset values that correspond to programmed axis addresses and offset numbers are rewritten.

**- Address name changing of format**

When bit 2 (OFS) of parameter No.11403 is set to 1, the specification address in "Y-axis offset and 4th/5th axis offset" can use address name 'A' or 'B' instead of default specification addresses 'Y', 'E' and 'F'.

Example) When parameters are set to follow, the command address 'A' and 'B' are used for setting of a tool offset.

- Parameter No.5044 is set to 4 (4th axis offset is the 4th axis)
- Parameter No.5045 is set to 5 (5th axis offset is the 5th axis)
- Parameter No.1020 (4th axis ,5th axis) = 65, 66 (Address name of 4th /5th axis offset is 'A' and 'B')
- Bit 2 (OFN) of No.11403 is set to 1 (Address depend on parameter No.1020)

%

**G10 P01 X\_ Z\_ A\_ B\_**

**G10 P02 X\_ Z\_ A\_ B\_**

...

**G10 P\_\_ X\_ Z\_ A\_ B\_**

%

A\_ : Tool compensation data (4th axis offset value in the example).

B\_ : Tool compensation data (5th axis offset value in the example).

The other addresses are the same as for the tool compensation amount.

#### NOTE

- 1 The axis name that can be used as a specification address is only 'A', and 'B'.  
If specification address 'A' or 'B' is used, the address 'V' (incremental command of Y-axis offset) cannot be used.
- 2 If the either of following is set, the default specification addresses 'Y', 'E', and 'F' are used.
  - Parameter No.1020 is set to axis name other than 'A(65)' or 'B(66)'.
  - An extended axis name is used.
- 3 When bit 2 (OFN) of parameter No.11403 is set to 1, conventional offset data cannot be read. If conventional offset data is read, set 0 to bit 2 (OFN) of parameter No.11403.

#### Limitation

1. This function is a software option.
2. This function supports the common memory between each path.
3. This function does not support direct input/counter input of tool offset values.
4. This function does not support offset value writing using a custom macro variable.
5. This function does not support the PMC window function.  
However, this function supports writing/reading of 4th/5th axis offset values to and from the C Language Executor.
6. This function does not support external data input. So, no 4th/5th axis offset value can be modified with a PMC ladder.
7. This function does not support the second geometry tool offset function.
8. This function does not support the tool management function.
9. This function does not support the wrong operation prevention function.

## 5.2 OVERVIEW OF TOOL NOSE RADIUS COMPENSATION (G40-G42)

It is difficult to produce the compensation necessary to form accurate parts when using only the tool offset function due to tool nose roundness in taper cutting or circular cutting. The tool nose radius compensation function compensates automatically for the above errors.

### NOTE

When bit 7 (NCR) of parameter No.8136 is 0, "Tool nose radius compensation" can be used.

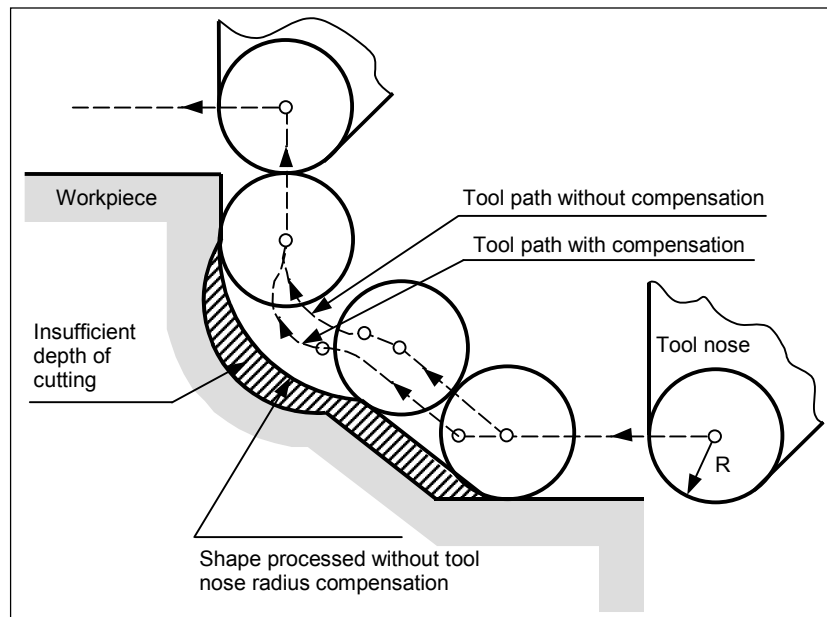

Fig 5.2 (a) Tool path of tool nose radius compensation

### 5.2.1 Imaginary Tool Nose

The tool nose at position A in Fig. 5.2.1 (a) does not actually exist.

The imaginary tool nose is required because it is usually more difficult to set the actual tool nose radius center to the start point than the imaginary tool nose.

Also when imaginary tool nose is used, the tool nose radius need not be considered in programming.

The position relationship when the tool is set to the start point is shown in Fig. 5.2.1 (a).

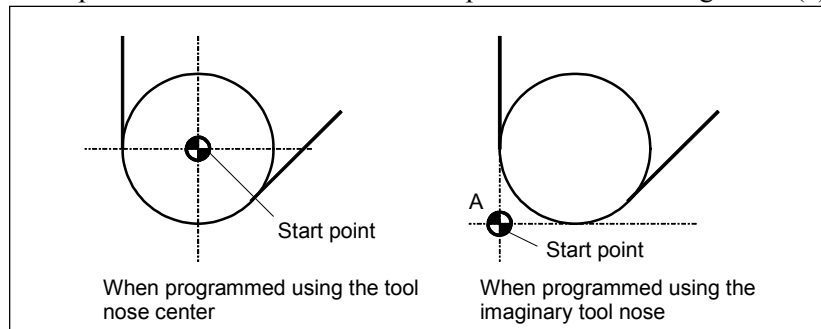
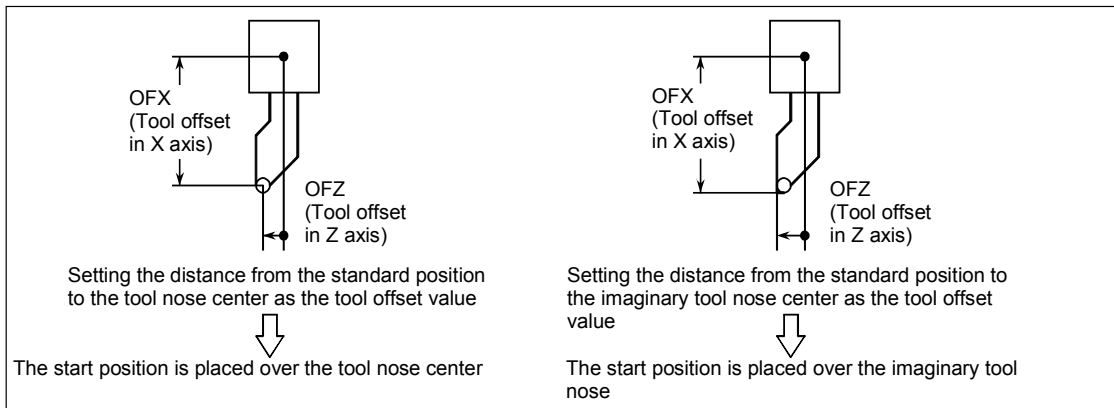

Fig. 5.2.1 (a) Tool nose radius center and imaginary tool nose

**CAUTION**

In a machine with reference positions, a standard position like the turret center can be placed over the start point. The distance from this standard position to the nose radius center or the imaginary tool nose is set as the tool offset value. Setting the distance from the standard position to the tool nose radius center as the offset value is the same as placing the tool nose radius center over the start point, while setting the distance from the standard position to the imaginary tool nose is the same as placing the imaginary tool nose over the standard position. To set the offset value, it is usually easier to measure the distance from the standard position to the imaginary tool nose than from the standard position to the tool nose radius center.



**Fig. 5.2.1 (b) Tool offset value when the turret center is placed over the start point**

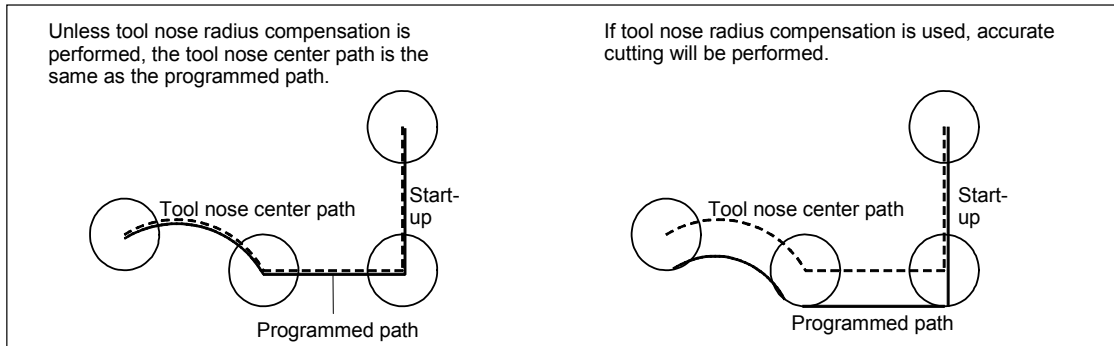

**Fig. 5.2.1 (c) Tool path when programming using the tool nose center**

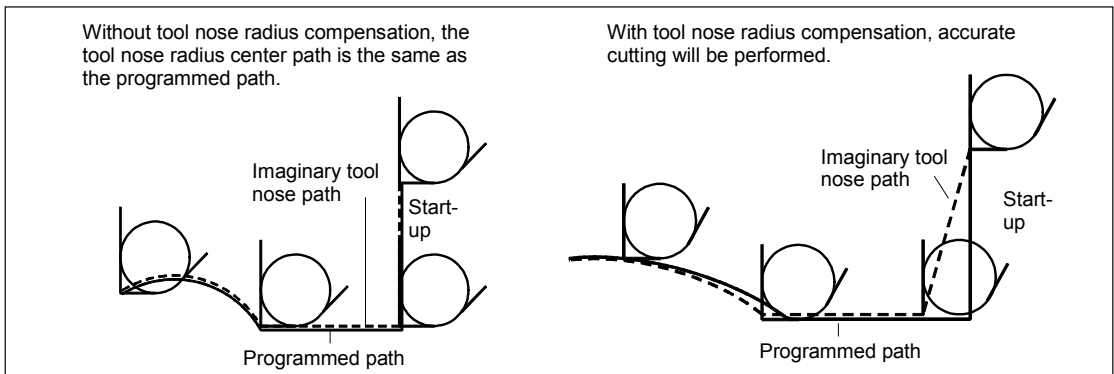

**Fig. 5.2.1 (d) Tool path when programming using the imaginary tool nose**



## 5.2.2 Direction of Imaginary Tool Nose

The direction of the imaginary tool nose viewed from the tool nose center is determined by the direction of the tool during cutting, so it must be set in advance as well as offset values.

The direction of the imaginary tool nose can be selected from the eight specifications shown in the Fig. 5.2.2 (a) below together with their corresponding codes. Fig. 5.2.2 (a) illustrates the relation between the tool and the start point. The following apply when the tool geometry offset and tool wear offset option are selected.

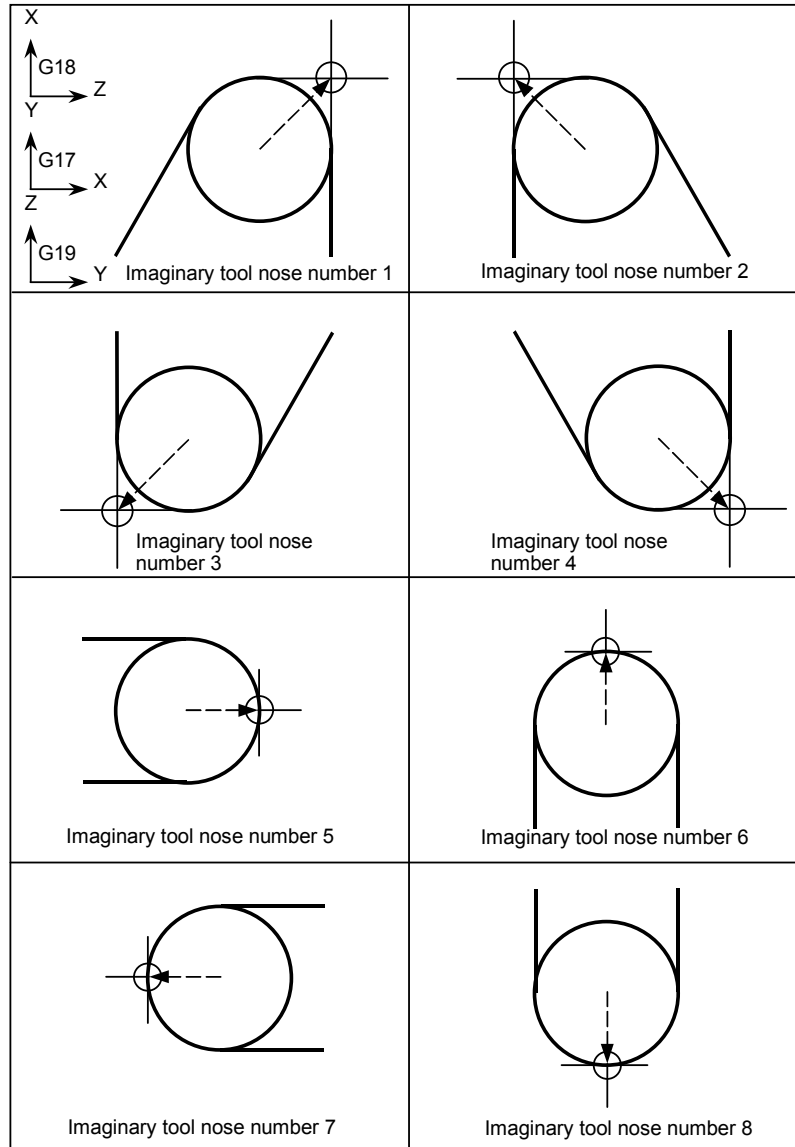

**Fig. 5.2.2 (a) Direction of imaginary tool nose**

Imaginary tool nose numbers 0 and 9 are used when the tool nose center coincides with the start point. Set imaginary tool nose number to address OFT for each offset number.

Bit 7 (WNP) of parameter No. 5002 is used to determine whether the tool geometry offset number or the tool wear offset number specifies the direction of the virtual tool nose for tool nose radius compensation.

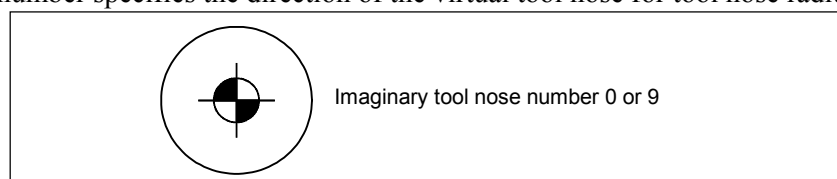

## 5.2.3 Offset Number and Offset Value

### Explanation

#### - Offset number and offset value

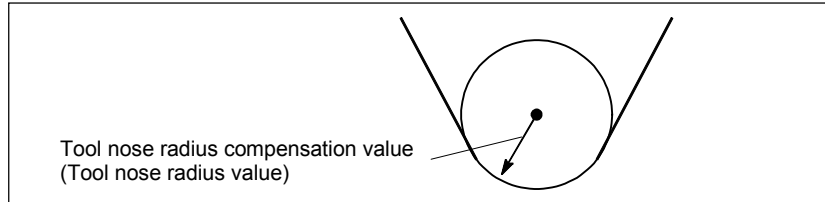

When the tool geometry compensation and tool wear compensation is disabled (bit 6 (NGW) of parameter No. 8136 is set to 1), the contents displayed on the tool offset screen become as Table 5.2.3 (a):

Table 5.2.3 (a) Offset number and offset value (example)

| Offset number<br>Up to 200 sets | OFX (Offset<br>value on X<br>axis) | OFZ (Offset<br>value on Z axis) | OFR (Tool nose<br>radius compensa-<br>tion value) | OFT (Direction of<br>imaginary tool<br>nose) | OFY (Offset<br>value on Y axis) |
|---------------------------------|------------------------------------|---------------------------------|---|--|---------------------------------|
| 001                             | 0.040                              | 0.020                           | 0.200   | 1  | 0.030                           |
| 002                             | 0.060                              | 0.030                           | 0.250   | 2  | 0.040                           |
| 003                             | 0.050                              | 0.015                           | 0.120   | 6  | 0.025                           |
| 004                             | :                                  | :                               | :   | :  | :                               |
| 005                             | :                                  | :                               | :   | :  | :                               |
| :                               | :                                  | :                               | :   | :  | :                               |

When the tool geometry compensation and tool wear compensation is enabled (bit 6 (NGW) of parameter No. 8136 is set to 0), the contents displayed on the tool offset screen become as Table 5.2.3 (b) and Table 5.2.3 (c):

Table 5.2.3 (b) Tool geometry offset (example)

| Geometry<br>offset number | OFGX<br>(X-axis<br>geometry<br>offset amount) | OFGZ<br>(Z-axis<br>geometry offset<br>amount) | OFGR<br>(Tool nose radius<br>geometry offset<br>value) | OFT (Imaginary<br>tool nose<br>direction) | OFGY<br>(Y-axis<br>geometry offset<br>amount) |
|---------------------------|---|---|--|---|---|
| G001                      | 10.040  | 50.020  | 0  | 1   | 70.020  |
| G002                      | 20.060  | 30.030  | 0  | 2   | 90.030  |
| G003                      | 0   | 0   | 0.200  | 6   | 0   |
| G004                      | :   | :   | :  | :   | :   |
| G005                      | :   | :   | :  | :   | :   |
| :                         | :   | :   | :  | :   | :   |

Table 5.2.3 (c) Tool wear offset (example)

| Wear offset<br>number | OFWX (X-axis<br>wear offset<br>amount) | OFWZ<br>(Z-axis wear<br>offset amount) | OFWR<br>(Tool nose radius<br>wear offset value) | OFT (Imaginary<br>tool nose<br>direction) | OFWY<br>(Y-axis wear<br>offset amount) |
|-----------------------|--|--|---|---|--|
| W001                  | 0.040                                  | 0.020                                  | 0   | 1   | 0.010                                  |
| W002                  | 0.060                                  | 0.030                                  | 0   | 2   | 0.020                                  |
| W003                  | 0                                      | 0                                      | 0.200   | 6   | 0                                      |
| W004                  | :                                      | :                                      | :   | :   | :                                      |
| W005                  | :                                      | :                                      | :   | :   | :                                      |
| :                     | :                                      | :                                      | :   | :   | :                                      |

### - Tool nose radius compensation

When tool geometry and wear compensation is enabled (bit 6 (NGW) of parameter No. 8136 is set to 0), the total of the geometry and wear offset amounts is used as the tool nose radius compensation value during execution.

$$\text{OFR}=\text{OFGR}+\text{OFWR}$$

### - Imaginary tool nose direction

The imaginary tool nose direction is common to geometry and wear offsets.

### - Command of offset value

A offset number is specified with the same T code as that used for tool offset.

#### NOTE

When the geometry offset number is made common to the tool selection by the bit 1 (LGN) of parameter No. 5002 setting and a T code for which the geometry offset and wear offset number differ from each other is designated, the imaginary tool nose direction specified by the geometry offset number is valid.

Example) T0102

$$\text{OFR}=\text{OFGR}_{01}+\text{OFWR}_{02}$$

$$\text{OFT}=\text{OFT}_{01}$$

By setting bit 7 (WNP) of parameter No. 5002 appropriately, the imaginary tool nose direction specified with the wear offset number can be made valid.

### - Setting range of offset value

The range of values that can be set as a compensation value is either of the Table 5.2.3 (d) and Table 5.2.3 (e), depending on the bits 1 (OFC) and 0 (OFA) of parameter No. 5042.

Table 5.2.3 (d) Valid compensation range (metric input)

| OFC | OFA | Range         |
|-----|-----|---------------|
| 0   | 1   | ±9999.99 mm   |
| 0   | 0   | ±9999.999 mm  |
| 1   | 0   | ±9999.9999 mm |

Table 5.2.3 (e) Valid compensation range (inch input)

| OFC | OFA | Range           |
|-----|-----|-----------------|
| 0   | 1   | ±999.999 inch   |
| 0   | 0   | ±999.9999 inch  |
| 1   | 0   | ±999.99999 inch |

The offset value corresponding to the offset number 0 is always 0.

No offset value can be set to offset number 0.

## 5.2.4 Workpiece Position and Move Command

In tool nose radius compensation, the position of the workpiece with respect to the tool must be specified.

| G code | Workpiece position | Tool path                                    |
|--------|--------------------|--|
| G40    | (Cancel)           | Moving along the programmed path             |
| G41    | Right side         | Moving on the left side the programmed path  |
| G42    | Left side          | Moving on the right side the programmed path |

The tool is offset to the opposite side of the workpiece.

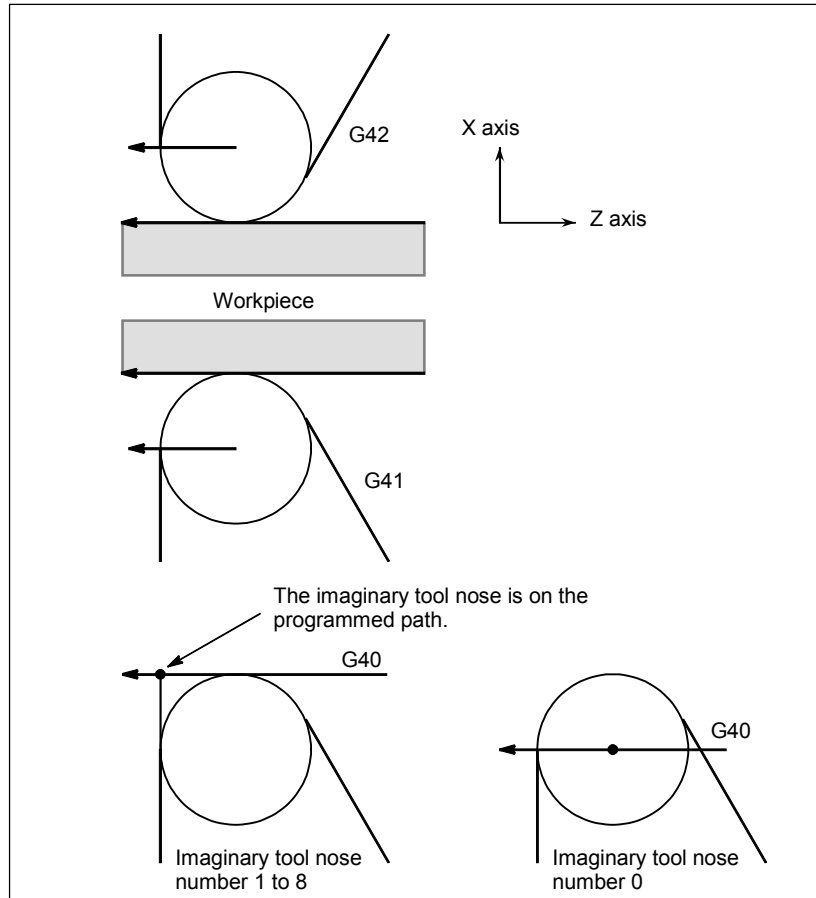

Fig. 5.2.4 (a) Workpiece position

The workpiece position can be changed by setting the coordinate system as shown below.

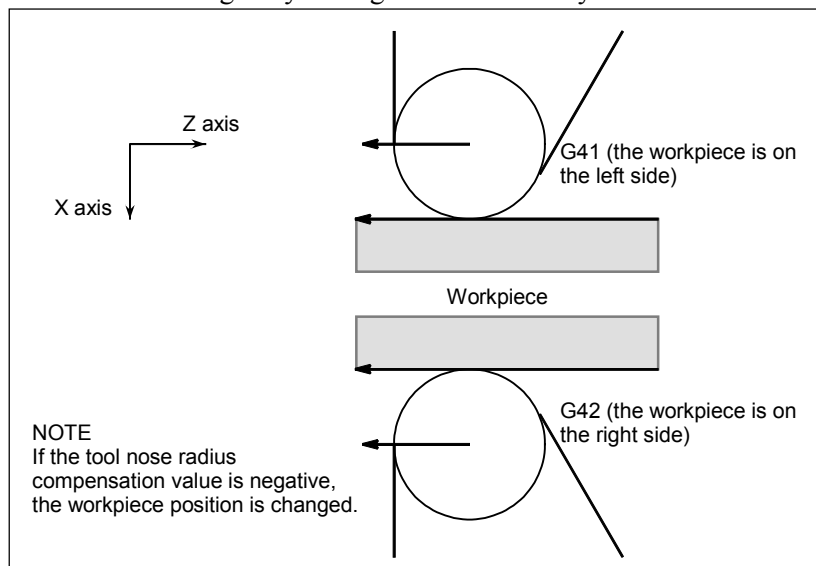

Fig. 5.2.4 (b) When the workpiece position is changed

G40, G41, and, G42 are modal.

Don't specify G41 while in the G41 mode. If you do, compensation will not work properly.

Don't specify G42 while in the G42 mode for the same reason.

G41 or G42 mode blocks in which G41 or G42 are not specified are expressed by (G41) or (G42) respectively.



**CAUTION**

If the sign of the compensation value is changed from plus to minus and vice versa, the offset vector of tool nose radius compensation is reversed, but the direction of the imaginary tool tip does not change. For a use in which the imaginary tool tip is adjusted to the starting point, therefore, do not change the sign of the compensation value for the assumed program.

**Explanation**

**- Tool movement when the workpiece position does not change**

When the tool is moving, the tool nose maintains contact with the workpiece.

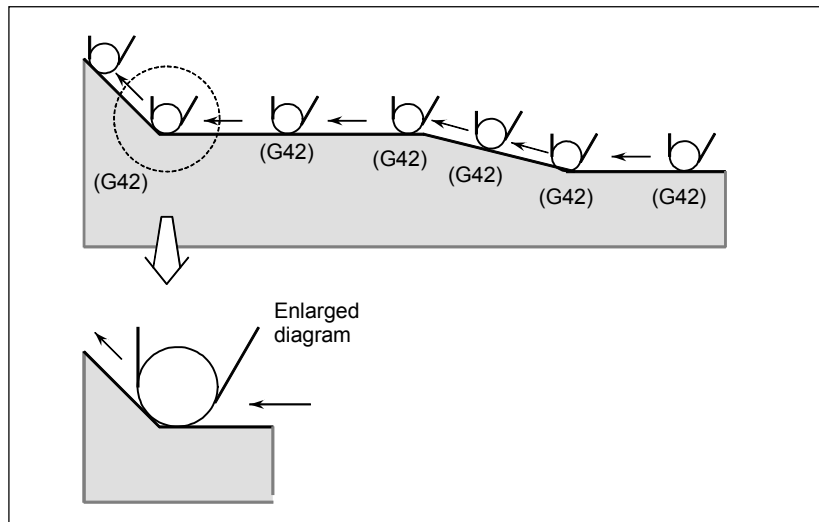

**Fig. 5.2.4 (c) Tool movement when the workpiece position does not change**

**- Tool movement when the workpiece position changes**

The workpiece position against the tool changes at the corner of the programmed path as shown in the Fig. 5.2.4 (d).

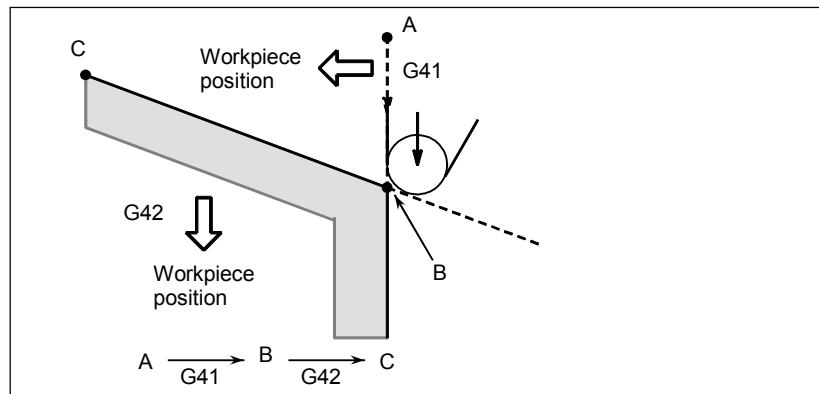

**Fig. 5.2.4 (d) Tool movement when the workpiece position changes**

Although the workpiece does not exist on the right side of the programmed path in the above case, the existence of the workpiece is assumed in the movement from A to B. The workpiece position must not be changed in the block next to the start-up block. In the above example, if the block specifying motion from A to B were the start-up block, the tool path would not be the same as the one shown.

**- Start-up**

The block in which the mode changes to G41 or G42 from G40 is called the start-up block.

G40 \_ ;

G41 \_ ; (Start-up block)

Transient tool movements for offset are performed in the start-up block. In the block after the start-up block, the tool nose center is positioned Vertically to the programmed path of that block at the start point.

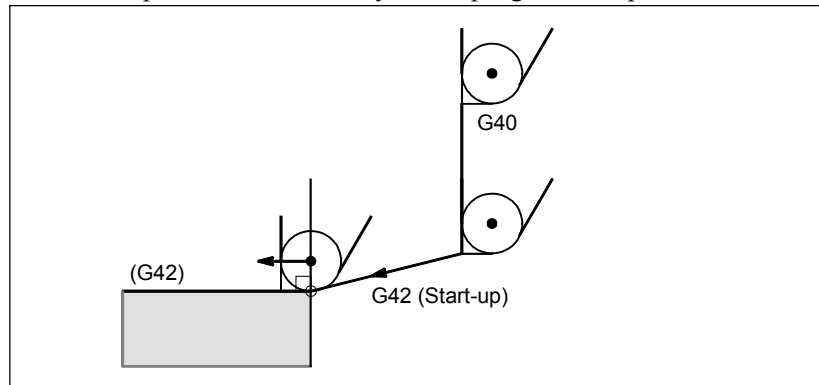

Fig. 5.2.4 (e) Start-up

### - Offset cancel

The block in which the mode changes to G40 from G41 or G42 is called the offset cancel block.

G41 \_ ;

G40 \_ ; (Offset cancel block)

The tool nose center moves to a position vertical to the programmed path in the block before the cancel block.

The tool is positioned at the end position in the offset cancel block (G40) as shown below.

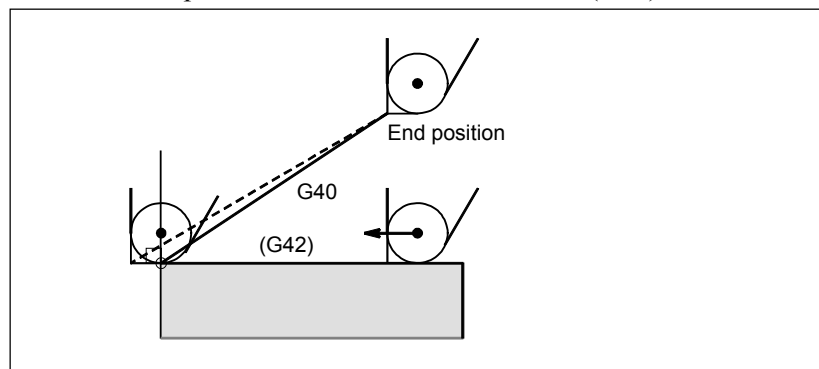

Fig. 5.2.4 (f) Offset cancel

### - Changing the compensation value

In general, the compensation value is to be changed when the tool is changed in offset cancel mode. If the compensation value is changed in offset mode, however, the vector at the end point of the block is calculated using the compensation value specified in that same block.

The same applies if the imaginary tool nose direction and the tool offset value are changed.

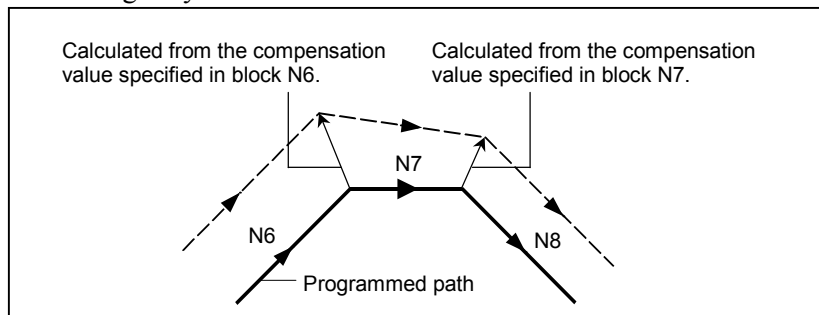
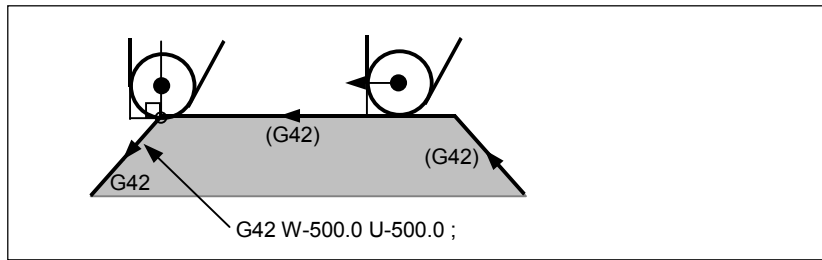

Fig. 5.2.4 (g) Changing the compensation value

**- Specification of G41/G42 in G41/G42 mode**

When a G41 or G42 code is specified again in G41/G42 mode, the tool nose center is positioned vertical to the programmed path of the preceding block at the end position of the preceding block.



**Fig. 5.2.4 (h) Specification of G41/G42 in G41/G42 mode**

In the block that first changes from G40 to G41/G42, the above positioning of the tool nose center is not performed.

**- Tool movement when the moving direction of the tool in a block which includes a G40 (offset cancel) command is different from the direction of the workpiece**

When you wish to retract the tool in the direction specified by X(U) and Z(W) canceling the tool nose radius compensation at the end of machining the first block in the Fig. 5.2.4 (i), specify the following :

G40 X(U) \_ Z(W) \_ I \_ K \_ ;

where I and K are the direction of the workpiece in the next block, which is specified in incremental mode.

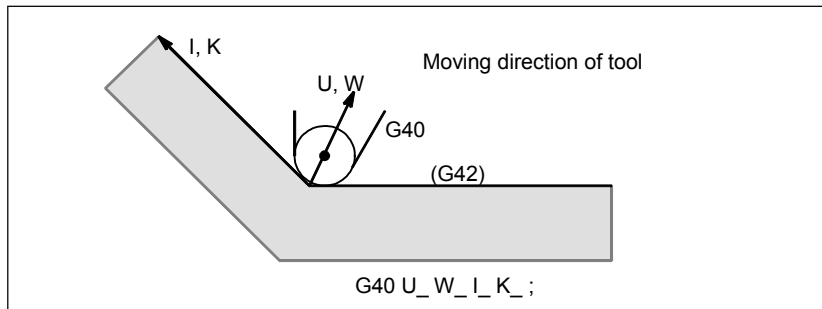

**Fig. 5.2.4 (i) If I and K are specified in the same block as G40**

Thus, this prevents the tool from overcutting, as shown in Fig. 5.2.4 (j).

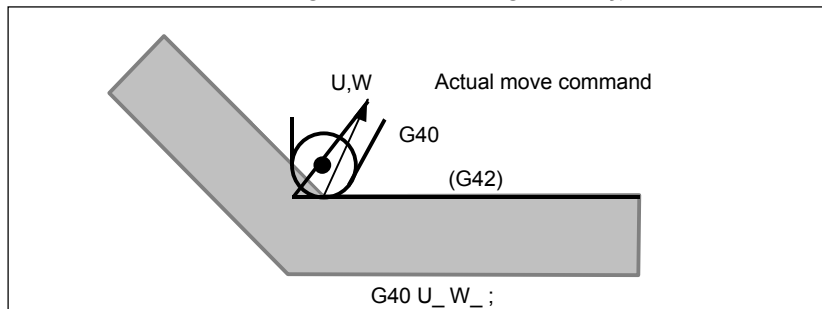

**Fig. 5.2.4 (j) Case in which overcutting occurs in the same block as G40**

The workpiece position specified by addresses I and K is the same as that in the preceding block.

Specify I\_K\_ ; in the same block as G40. If it is specified in the same block as G02 or G03, it is assumed to be the center of the arc.

|                       |                               |
|-----------------------|-------------------------------|
| G40 X _ Z _ I _ K _ ; | Tool nose radius compensation |
| G02 X _ Z _ I _ K _ ; | Circular interpolation        |

If I and/or K is specified with G40 in the offset cancel mode, the I and/or K is ignored. The numeral is followed I and K should always be specified as radius values.

G40 G01 X\_ Z\_ ;

G40 G01 X\_ Z\_ I\_ K\_ ; Offset cancel mode (I and K are ineffective.)

## Example

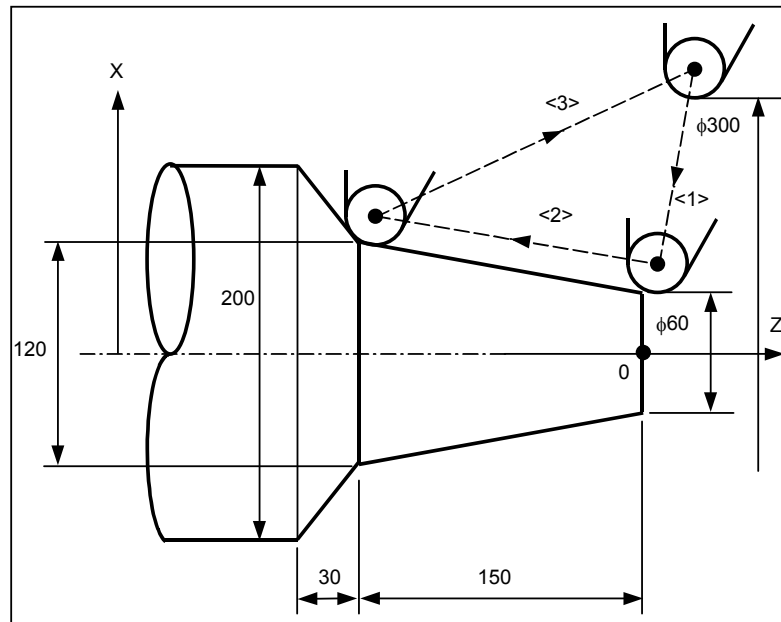

(G40 mode)

<1> G42 G00 X60.0 ;

<2> G01 X120.0 W-150.0 F10 ;

<3> G40 G00 X300.0 W150.0 I40.0 K-30.0 ;

## 5.2.5 Notes on Tool Nose Radius Compensation

### Explanation

#### - Blocks without a move command that are specified in offset mode

|                                   |                        |
|-----------------------------------|------------------------|
| <1> M05 ;                         | M code output          |
| <2> S210 ;                        | S code output          |
| <3> G04 X10.0 ;                   | Dwell                  |
| <4> G22 X100000 ;                 | Machining area setting |
| <5> G01 U0 ;                      | Feed distance of zero  |
| <6> G98 ;                         | G code only            |
| <7> G10 P01 X10.0 Z20.0 R0.5 Q2 ; | Offset change          |

If the number of such blocks consecutively specified is more than N-2 blocks (where N is the number of blocks to read in offset mode (parameter No. 19625)), the tool arrives at the position vertical to this block at the end point of the previous block.

If the feed distance is 0 (<5>), this applies even if only one block is specified.



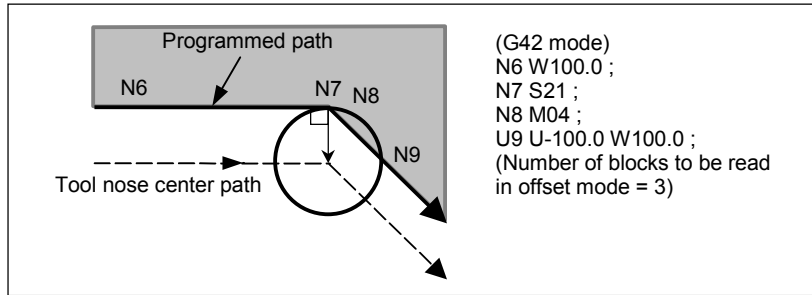

Fig. 5.2.5 (a) Case in which overcutting occurs

Overcutting may, therefore, occur in the Fig. 5.2.5 (a).

- Tool nose radius compensation with G90 or G94

The tool nose center path and the offset direction are as shown below if tool nose radius compensation is applied. At the cycle start point, the offset vector disappears, and offset starts up with tool movement from the cycle start point. In addition, during a return to the cycle start point, the offset vector disappears temporarily, and offset is applied again with the next move command. The offset direction is determined by the cutting pattern, regardless of G41 or G42.

- Outer/inner turning cycle (G90)

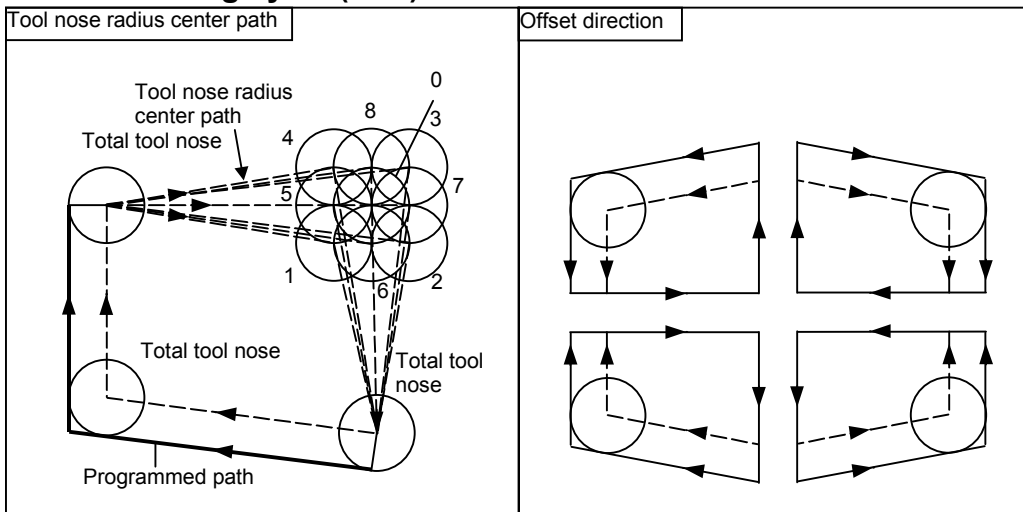

- End cutting cycle (G94)

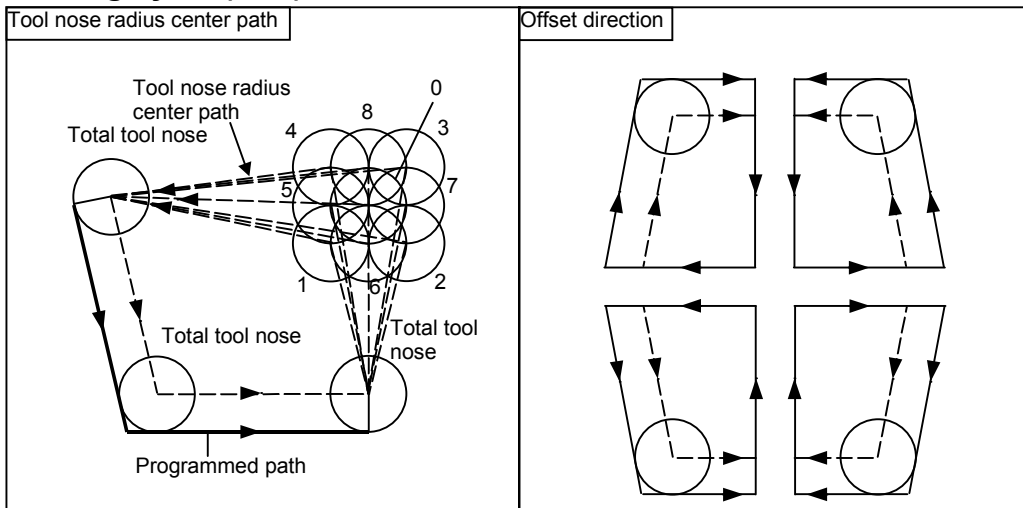

### - Difference from Series 16i/18i/21i

#### NOTE

The offset direction is the same as that of Series 16i/18i/21i, but the tool nose radius center path is different.

- For this CNC

The operation is the same as that performed if the canned cycle operation is replaced with G00 or G01, start-up is performed in the first block for movement from the start point, and offset cancel is performed in the last block for returning to the start point.

- For Series 16i/18i/21i

The operation with the block for movement from the start point and the last block for returning to the start point differs from that of this CNC. For details, refer to the Series 16i/18i/21i Operator's Manual.

### - Tool nose radius compensation with G71 to G73

Tool nose radius compensation performed with G71 (outer surface rough cutting cycle or traverse grinding cycle), G72 (end rough cutting cycle or traverse direct constant-size grinding cycle), and G73 (closed loop cutting cycle or oscillation direct constant-size grinding cycle), see the explanations of the respective cycles.

### - Tool nose radius compensation with G74 to G76 and G92

With G74 (end cutting off cycle), G75 (outer/inner surface cutting off cycle), G76 (multiple threading cycle), and G92 (threading cycle), tool nose radius compensation cannot be applied.

### - Tool nose radius compensation when chamfering is performed

Movement after compensation is shown Fig. 5.2.5 (b).

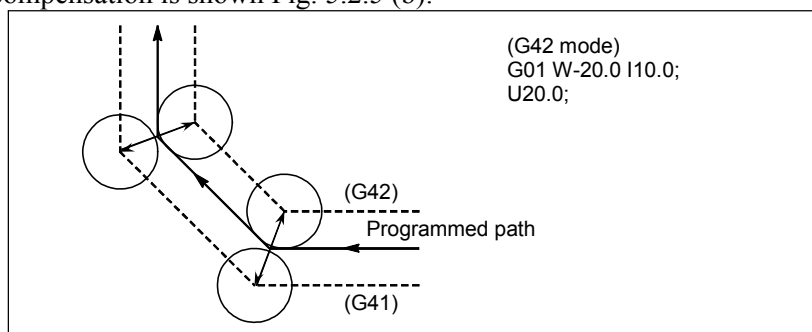

Fig. 5.2.5 (b) Tool nose radius compensation when chamfering is performed

### - Tool nose radius compensation when a corner arc is inserted

Movement after compensation is shown Fig. 5.2.5 (c).

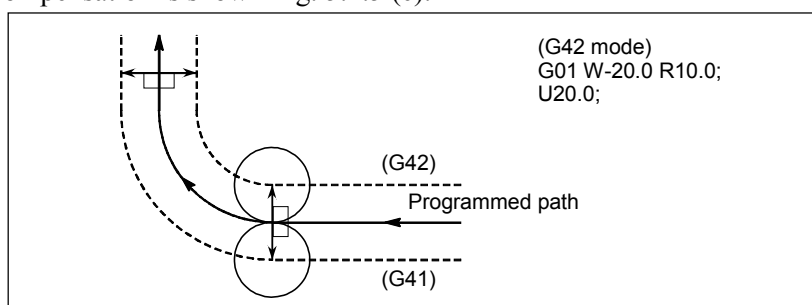

Fig. 5.2.5 (c) Tool nose radius compensation when a corner arc is inserted

## 5.3 OVERVIEW OF CUTTER COMPENSATION (G40-G42)

When the tool is moved, the tool path can be shifted by the radius of the tool (Fig. 5.3 (a)).

To make an offset as large as the radius of the tool, CNC first creates an offset vector with a length equal to the radius of the tool (start-up). The offset vector is perpendicular to the tool path. The tail of the vector is on the workpiece side and the head positions to the center of the tool.

If a linear interpolation or circular interpolation command is specified after start-up, the tool path can be shifted by the length of the offset vector during machining.

To return the tool to the start point at the end of machining, cancel the cutter compensation mode.

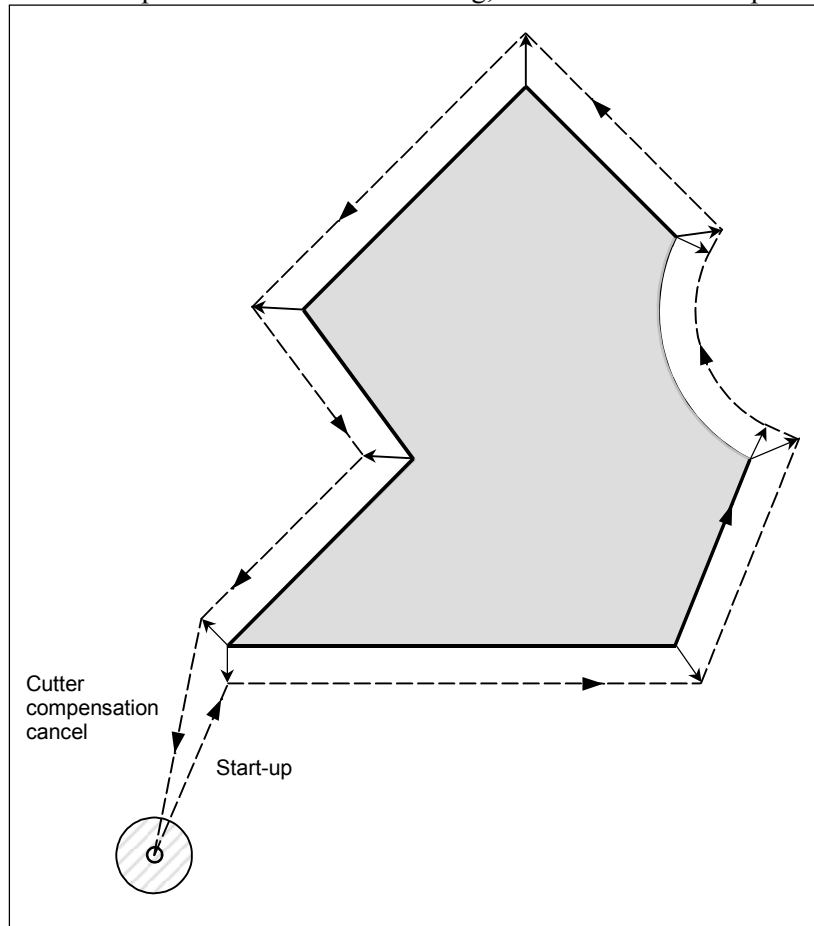

Fig. 5.3 (a) Outline of cutter compensation

### Format

#### - Start up (tool compensation start)

**G00(or G01)G41(or G42) IP\_T\_;**

G41 : Cutter compensation left (Group 07)

G42 : Cutter compensation right (Group 07)

IP\_ : Command for axis movement

T\_ : Same T code as that of tool offset

#### - Cutter compensation cancel (offset mode cancel)

**G40 IP\_;**

G40 : Cutter compensation cancel (Group 07)  
(Offset mode cancel)

IP\_ : Command for axis movement

### - Selection of the offset plane

| Offset plane | Command for plane selection | IP    |
|--------------|-----------------------------|-------|
| XpYp         | G17 ;                       | Xp Yp |
| ZpXp         | G18 ;                       | Xp Zp |
| YpZp         | G19 ;                       | Yp Zp |

## Explanation

### - Offset cancel mode

At the beginning when power is applied the control is in the offset cancel mode. In the offset cancel mode, the vector is always 0, and the tool center path coincides with the programmed path.

### - Start-up

When a cutter compensation command (G41 or G42) is specified in the offset cancel mode, the CNC enters the offset mode.

Moving the tool with this command is called start-up.

Specify positioning (G00) or linear interpolation (G01) for start-up.

If circular interpolation (G02, G03) is specified, alarm PS0034, "ONLY G00/G01 ALLOWED IN STUP/EXT BLK" occurs.

For the start-up and subsequent blocks, the CNC prereads as many blocks as the number of preread blocks set in the parameter No. 19625.

### - Offset mode

In the offset mode, compensation is accomplished by positioning (G00), linear interpolation (G01), or circular interpolation (G02, G03).

If three or more blocks that move the tool cannot be read in offset mode, the tool may make either an excessive or insufficient cut.

If the offset plane is switched in the offset mode, alarm PS0037, "CAN NOT CHANGE PLANE IN G41/G42" occurs and the tool is stopped.

### - Offset mode cancel

In the offset mode, when a block which satisfies any one of the following conditions is executed, the CNC enters the offset cancel mode, and the action of this block is called the offset cancel.

1. G40 has been commanded.
2. 0 has been commanded as the offset number for cutter compensation (T code).

When performing offset cancel, circular arc commands (G02 and G03) are not available. If these commands are specified, an alarm PS0034 is generated and the tool stops. In the offset cancel, the control executes the instructions in that block and the block in the cutter compensation buffer.

In the meantime, in the case of a single block mode, after reading one block, the control executes it and stops. By pushing the cycle start button once more, one block is executed without reading the next block.

Then the control is in the offset cancel mode, and normally, the block to be executed next will be stored in the buffer register and the next block is not read into the buffer for cutter compensation.

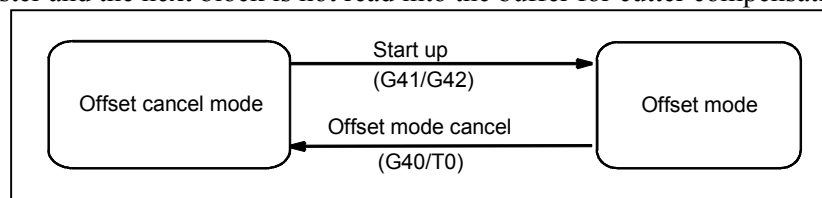

Fig. 5.3 (b) Changing the offset mode

### - Change of the cutter compensation value

In general, the cutter compensation value shall be changed in the offset cancel mode, when changing tools. If the cutter compensation value is changed in offset mode, the vector at the end point of the block is calculated for the new cutter compensation value.

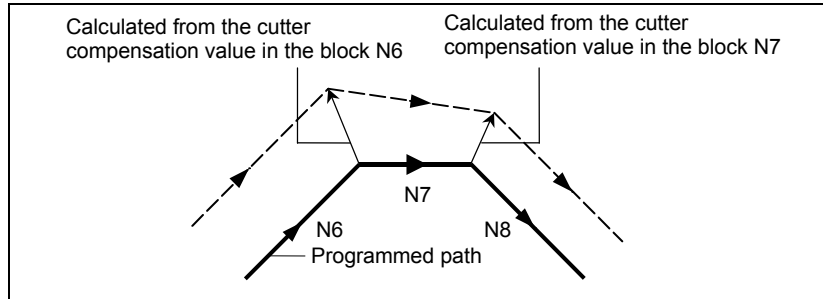

Fig. 5.3 (c) Changing the cutter compensation value

**- Positive/negative cutter compensation value and tool center path**

If the compensation value is negative (-), distribution is made for a figure in which G41's and G42's are all replaced with each other on the program. Consequently, if the tool center is passing around the outside of the workpiece, it will pass around the inside, and vice versa.

Fig. 5.3 (d) shows one example.

Generally, the compensation value is programmed to be positive (+).

When a tool path is programmed as in <1>, if the compensation value is made negative (-), the tool center moves as in <2>, and vice versa. Consequently, the same program permits cutting both male and female shapes, and any gap between them can be adjusted by the selection of the compensation value.

Applicable if start-up and cancel is A type. (See the descriptions about the start-up of cutter compensation.)

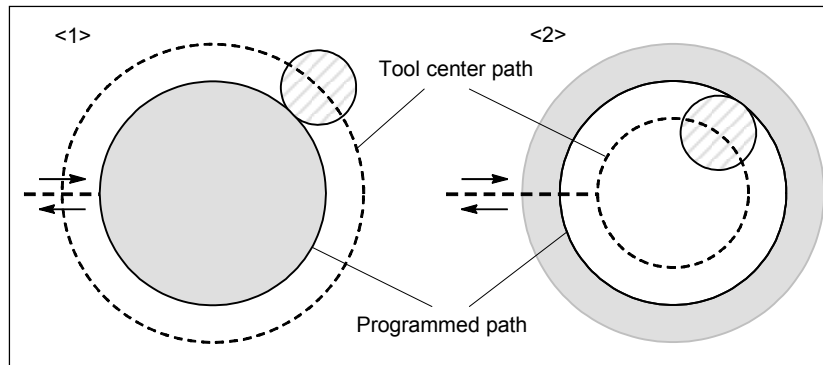

Fig. 5.3 (d) Tool center paths when positive and negative cutter compensation values are specified

**- Cutter compensation value setting**

Assign a cutter compensation values to the T codes on the MDI unit.

**NOTE**

The cutter compensation value for which the T code corresponds to 0 always means 0.

It is not possible to set the cutter compensation value corresponding to T0.

**- Valid compensation value range**

The valid range of values that can be set as a compensation value is either of the following, depending on the bits 1 (OFC), and 0 (OFA) of parameter No. 5042.

Valid compensation range (metric input)

| OFC | OFA | Range         |
|-----|-----|---------------|
| 0   | 1   | ±9999.99 mm   |
| 0   | 0   | ±9999.999 mm  |
| 1   | 0   | ±9999.9999 mm |

Valid compensation range (inch input)

| OFC | OFA | Range           |
|-----|-----|-----------------|
| 0   | 1   | ±999.999 inch   |
| 0   | 0   | ±999.9999 inch  |
| 1   | 0   | ±999.99999 inch |

The compensation value corresponding to offset No. 0 always means 0.

It is not possible to set the compensation value corresponding to offset No. 0.

#### - Offset vector

The offset vector is the two dimensional vector that is equal to the cutter compensation value assigned by T code. It is calculated inside the control unit, and its direction is up-dated in accordance with the progress of the tool in each block.

The offset vector is deleted by reset.

#### - Specifying a cutter compensation value

Specifying a cutter compensation value is accomplished by specifying an offset number, using the same T code as that for specifying tool offset.

#### - Plane selection and vector

Offset calculation is carried out in the plane determined by G17, G18 and G19, (G codes for plane selection). This plane is called the offset plane.

Compensation is not executed for the coordinate of a position which is not in the specified plane. The programmed values are used as they are. In simultaneous 3 axes control, the tool path projected on the offset plane is compensated.

The offset plane is changed during the offset cancel mode.

If it is performed during the offset mode, an alarm PS0037 is displayed and the machine is stopped.

**Example**

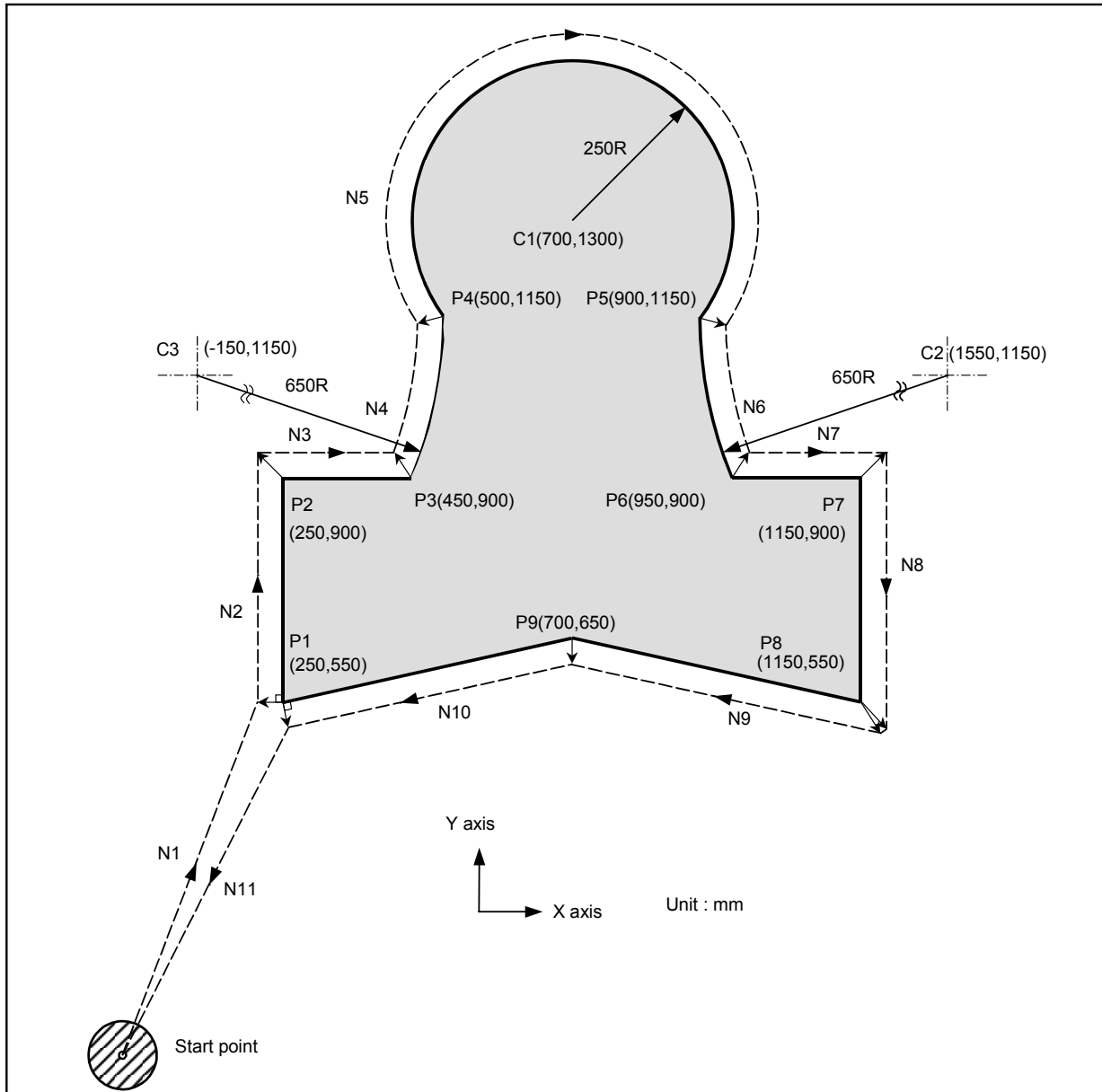

**G50 X0 Y0 Z0 ;** ..... Specifies absolute coordinates.  
 The tool is positioned at the start point (X0, Y0, Z0).

**N1 G17 G00 G41 T0707 X250.0 Y550.0 ;** ..... Starts cutter compensation (start-up).  
 The tool is shifted to the left of the programmed path by the distance specified in T07.  
 In other words the tool path is shifted by the radius of the tool (offset mode) because T07 is set to 15 beforehand (the radius of the tool is 15 mm).

**N2 G01 Y900.0 F150 ;** ..... Specifies machining from P1 to P2.

**N3 X450.0 ;** ..... Specifies machining from P2 to P3.

**N4 G03 X500.0 Y1150.0 R650.0 ;** ..... Specifies machining from P3 to P4.

**N5 G02 X900.0 R-250.0 ;** ..... Specifies machining from P4 to P5.

**N6 G03 X950.0 Y900.0 R650.0 ;** ..... Specifies machining from P5 to P6.

**N7 G01 X1150.0 ;** ..... Specifies machining from P6 to P7.

**N8 Y550.0 ;** ..... Specifies machining from P7 to P8.

**N9 X700.0 Y650.0 ;** ..... Specifies machining from P8 to P9.

**N10 X250.0 Y550.0 ;** .....Specifies machining from P9 to P1.

**N11 G00 G40 X0 Y0 ;** .....Cancels the offset mode.

The tool is returned to the start point (X0, Y0, Z0).



## 5.4 DETAILS OF CUTTER OR TOOL NOSE RADIUS COMPENSATION

### 5.4.1 Overview

The following explanation focuses on tool nose radius compensation, but applies to cutter compensation as well. Examples in which XY planes are used, however, apply to cutter compensation only.

#### - Tool nose radius center offset vector

The tool nose radius center offset vector is a two dimensional vector equal to the offset value specified in a T code, and the vector is calculated in the CNC. Its dimension changes block by block according to tool movement.

This offset vector (simply called vector herein after) is internally created by the control unit as required for proper offsetting and to calculate a tool path with exact offset (by tool nose radius) from the programmed path.

This vector is deleted by resetting.

The vector always accompanies the tool as the tool advances.

Proper understanding of vector is essential to accurate programming.

Read the description below on how vectors are created carefully.

#### - G40, G41, G42

G40, G41 or G42 is used to delete or generate vectors.

These codes are used together with G00, G01, G02, or G32 to specify a mode for tool motion (Offsetting).

| G code | Workpiece position | Function                             |
|--------|--------------------|--------------------------------------|
| G40    | Neither            | Tool nose radius compensation cancel |
| G41    | Right              | Left offset along tool path          |
| G42    | Left               | Right offset along tool path         |

G41 and G42 specify an offset mode, while G40 specifies cancellation of the offset.

#### - Inner side and outer side

When an angle of intersection of the tool paths specified with move commands for two blocks on the workpiece side is over 180°, it is referred to as "inner side." When the angle is between 0° and 180°, it is referred to as "outer side."

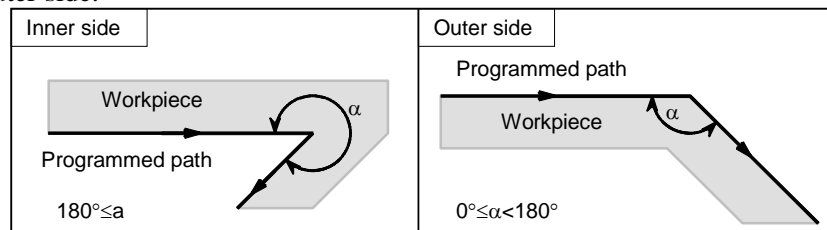

#### - Outer corner connection method

If the tool moves around an outer corner in tool nose radius compensation mode, it is possible to specify whether to connect compensation vectors with linear interpolation or with circular interpolation, using bit 2 (CCC) of parameter No. 19607.

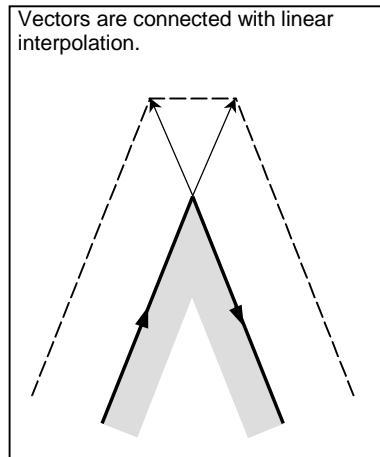

Fig. 5.4.1 (a) Linear connection type  
[Bit 2 (CCC) of parameter No. 19607 = 0]

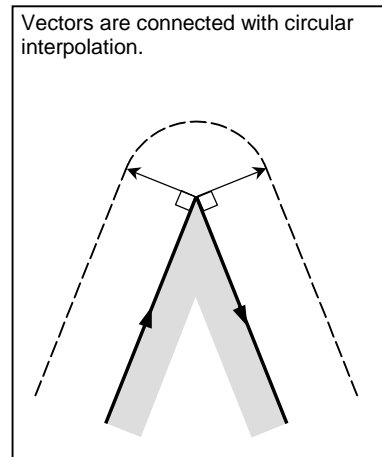



Fig.5.4.1 (b) Circular connection type  
[Bit 2 (CCC) of parameter No. 19607 = 1]

### - Cancel mode

The tool nose radius compensation enters the cancel mode under the following conditions. (The system may not enter the cancel mode depending on the machine tool.)

- (1) Immediately after the power is turned on
- (2) After the  key on the MDI unit is pushed
- (3) After a program is forced to end by executing M02 or M30
- (4) After the tool nose radius compensation cancel command (G40) is exercised

In the cancel mode, the magnitude of a compensation vector is 0 at all times and the path of the virtual tool nose matches the programmed path. A program must end in cancel mode. If it ends in the tool nose radius compensation mode, the tool cannot be positioned at the end point, and the tool stops at a location the compensation vector length away from the end point.

### NOTE

The operation performed when a reset operation is performed during tool nose radius compensation varies according to the setting of bit 6 (CLR) of parameter No. 3402.

- When CLR=0  
The reset state is set. The modal information of G41/G42 in group 07 is preserved. To perform tool nose radius compensation, however, an offset number (T code) needs to be specified again.
- When CLR=1  
The cleared state is set. The modal information of G40 in group 07 is preserved. To perform tool nose radius compensation, G41/G42 and an offset number (T code) need to be specified.

### - Start-up

When a block which satisfies all the following conditions is executed in cancel mode, the CNC enters the offset mode. Control during this operation is called start-up.

- (1) G41 or G42 is contained in the block, or has been specified to place the CNC in the offset mode.
  - (2)  $0 < \text{compensation number of tool nose radius compensation} \leq \text{maximum compensation number}$
  - (3) Positioning (G00) or linear interpolation (G01) mode
  - (4) A compensation plane axis command with a travel distance of 0 (except start-up type C) is specified.
- If start-up is specified in circular interpolation (G02, G03) mode, alarm PS0034, "NO CIRC ALLOWED IN STUP/EXT BLK" will occur.

Workpiece coordinate system switching (G54 to G59) cannot be specified in the start-up block.

As a start-up operation, one of the three types A, B, and C can be selected by setting bits 0 (SUP) and 1 (SUV) of parameter No. 5003 appropriately. The operation to be performed if the tool moves around an inner side is of single type only.

**Table 5.4.1 (a) Start-up/cancel operation**

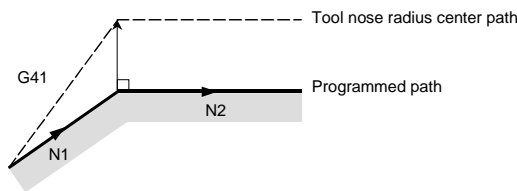
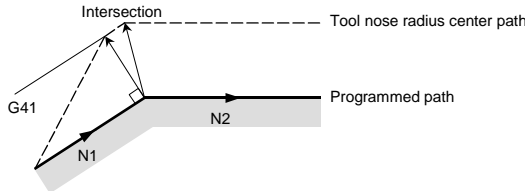
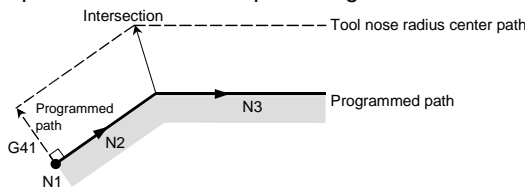
| SUV | SUP | Type   | Operation  |
|-----|-----|--------|--|
| 0   | 0   | Type A | <p>A compensation vector is output, which is vertical to the block subsequent to the start-up block and the block preceding the cancel block.</p>    |
| 0   | 1   | Type B | <p>A compensation vector is output, which is vertical to the start-up block and the cancel block. An intersection vector is also output.</p>   |
| 1   | 0   | Type C | <p>When the start-up block and the cancel block are blocks without tool movement, the tool moves by the cutter or tool nose radius compensation value in the direction vertical to the block subsequent to the start-up block and the block preceding the cancel block.</p>  <p>For a block with tool movement, the tool follows the SUP setting: If it is 0, type A is assumed and if 1, type B is assumed.</p> |

**- Reading input commands in tool nose radius compensation mode**

In tool nose radius compensation mode, input commands are read from usually three blocks and up to eight blocks depending on the setting of parameter No. 19625 to perform intersection calculation or an interference check, described later, regardless of whether the blocks are with or without tool movement, until a cancel command is received.

To perform intersection calculation, it is necessary to read at least two blocks with tool movement. To perform an interference check, it is necessary to read at least three blocks with tool movement.

As the setting of parameter No. 19625, that is, the number of blocks to read, increases, it is possible to predict overcutting (interference) for up to more subsequent commands. Increases in blocks to read and analyze, however, cause reading and analysis to take more time.

### - Bit 0 (SBK) of parameter No. 5000

When bit 0 (SBK) of parameter No. 5000 is set to 1, a single block stop can be performed in a block created internally for tool nose radius compensation.

Use this parameter to check a program including tool nose radius compensation.

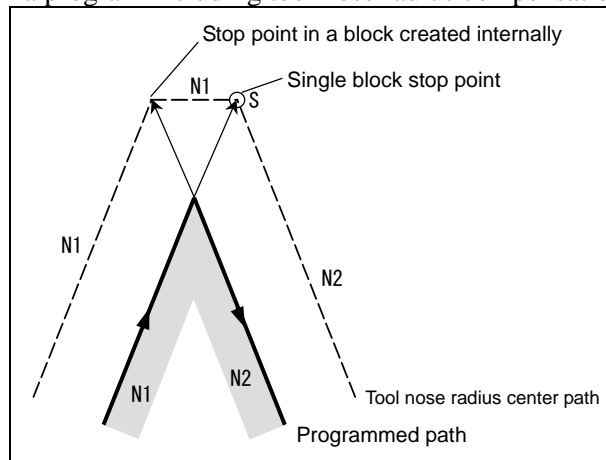

### NOTE

When an auxiliary function (M code), spindle speed function (S code), tool function (T code), or second auxiliary function (B code) is specified in the N1 block in the figure above, FIN is not accepted if the tool stops at the stop point in a block created internally (excluding the single block stop point).

### - Meaning of symbols

The following symbols are used in subsequent figures:

- S indicates a position at which a single block is executed once.
- SS indicates a position at which a single block is executed twice.
- SSS indicates a position at which a single block is executed three times.
- L indicates that the tool moves along a straight line.
- C indicates that the tool moves along an arc.
- r indicates the cutter or tool nose radius compensation value.
- An intersection is a position at which the programmed paths of two blocks intersect with each other after they are shifted by r.
- ○ indicates the center of the tool nose radius.

## 5.4.2 Tool Movement in Start-up

When the offset cancel mode is changed to offset mode, the tool moves as illustrated below (start-up):

### Explanation

- Tool movement around an inner side of a corner ( $180^\circ \leq \alpha$ )

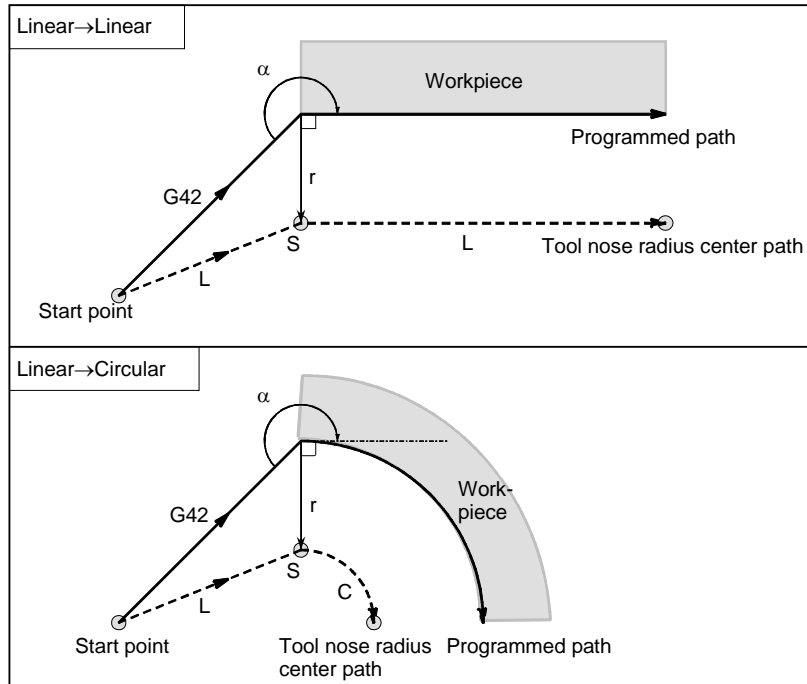

- Cases in which the start-up block is a block with tool movement and the tool moves around the outside at an obtuse angle ( $90^\circ \leq \alpha < 180^\circ$ )

Tool path in start-up has two types A and B, and they are selected by bit 0 (SUP) of parameter No. 5003.

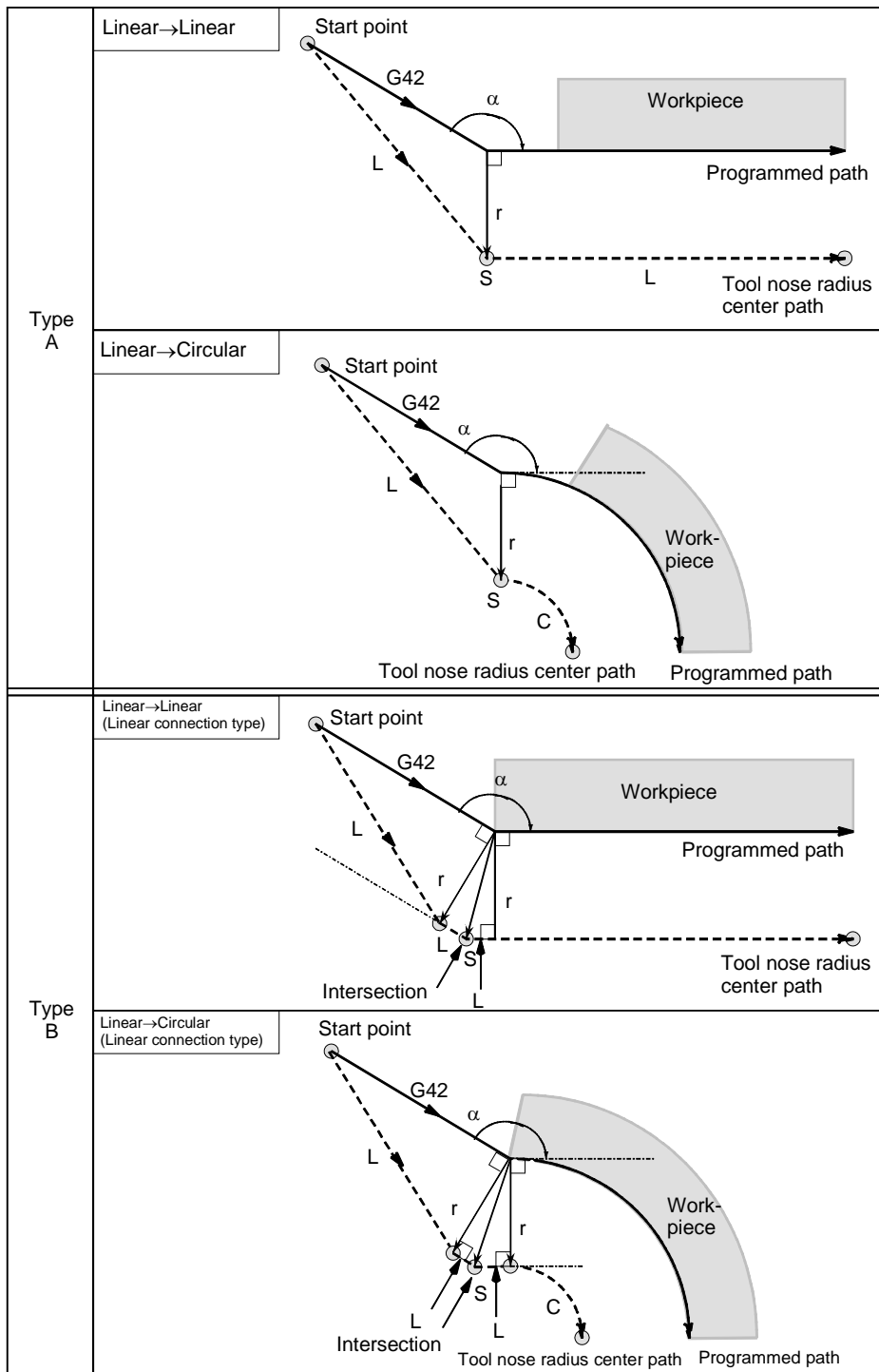

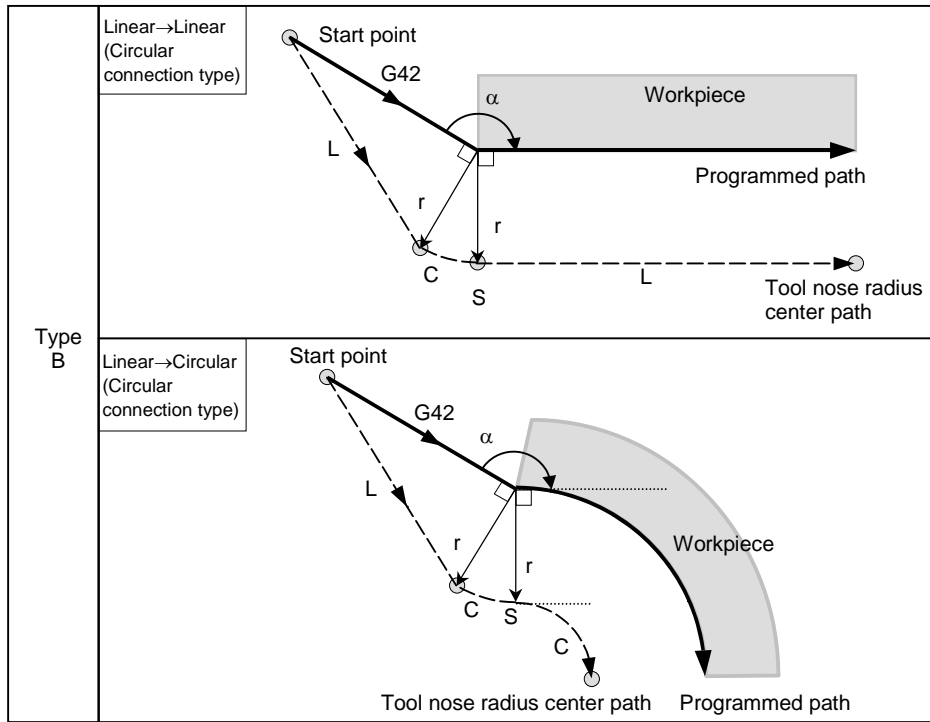

- Cases in which the start-up block is a block with tool movement and the tool moves around the outside at an acute angle ( $\alpha < 90^\circ$ )

Tool path in start-up has two types A and B, and they are selected by bit 0 (SUP) of parameter No. 5003.

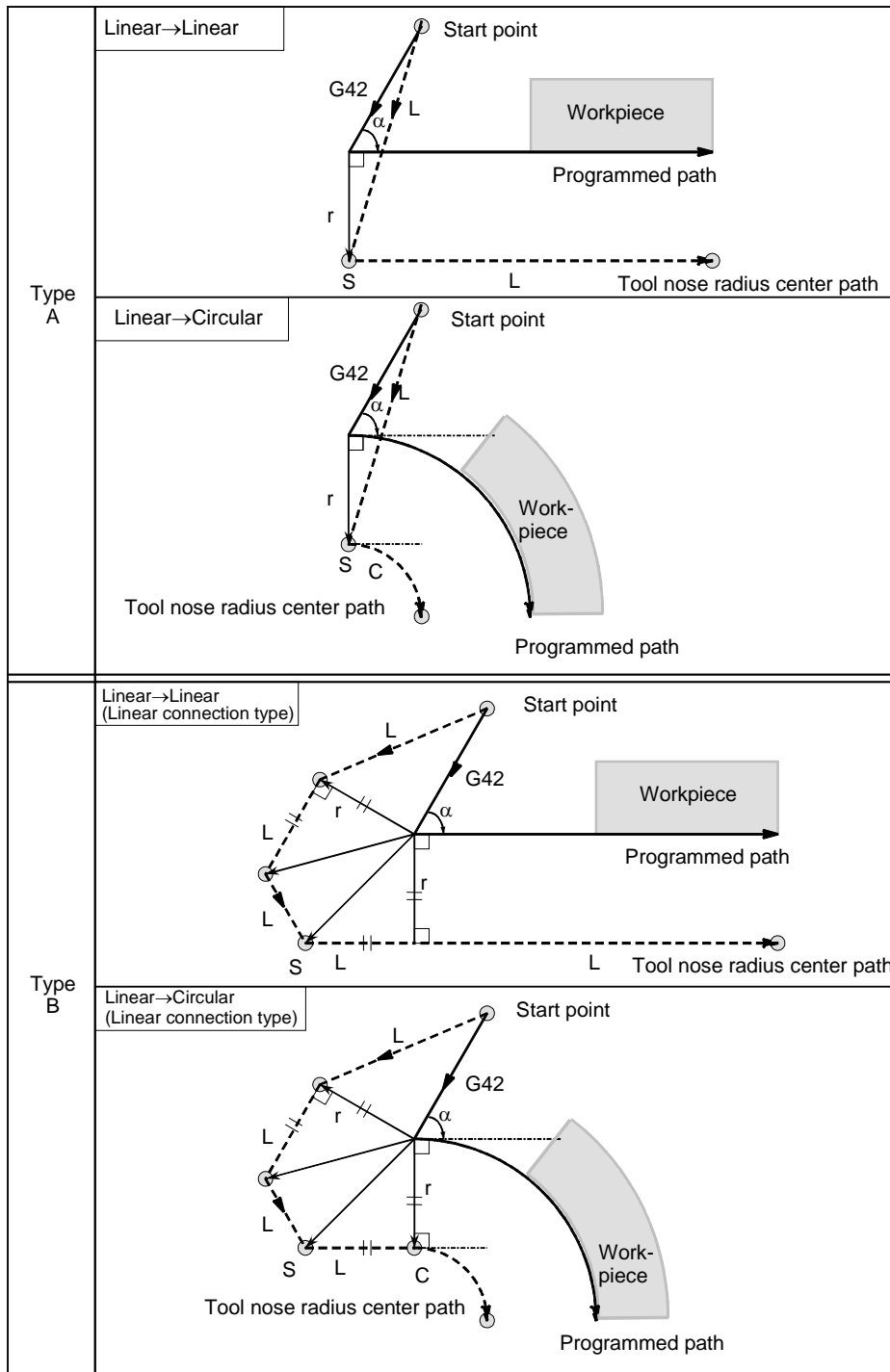



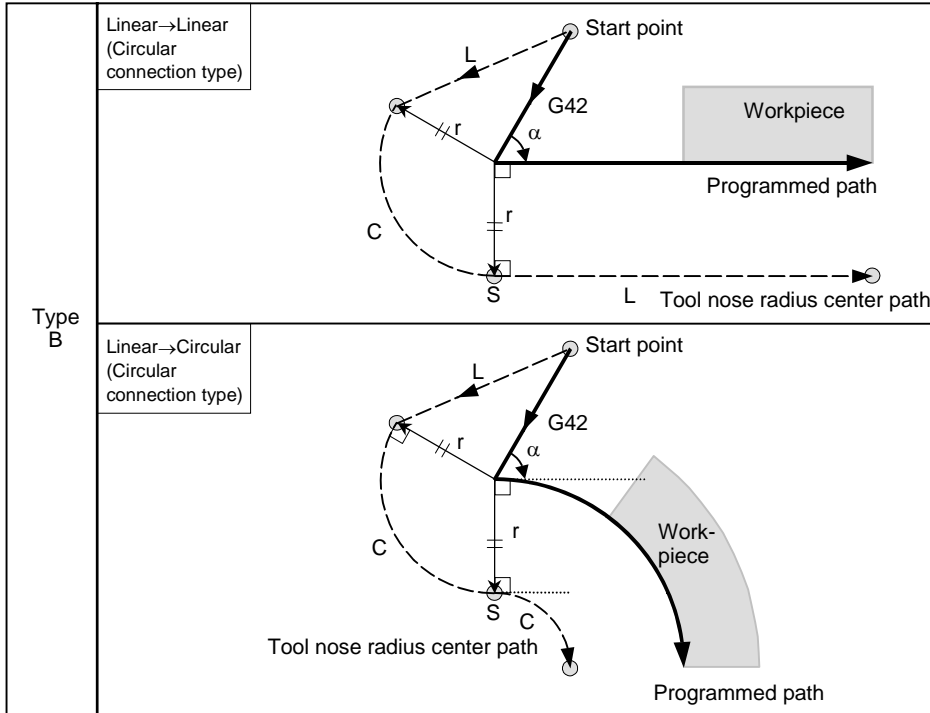

- **Tool movement around the outside linear → linear at an acute angle less than 1 degree ( $\alpha < 1^\circ$ )**

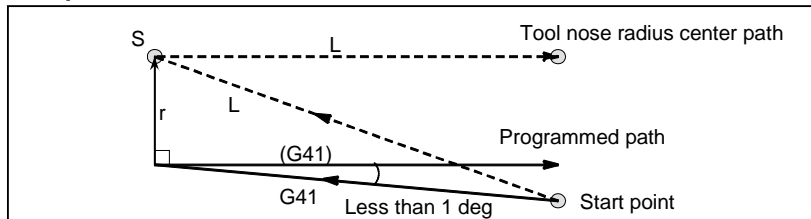

- **A block without tool movement specified at start-up**

For type A and B

If the command is specified at start-up, the offset vector is not created. The tool does not operate in a start-up block.

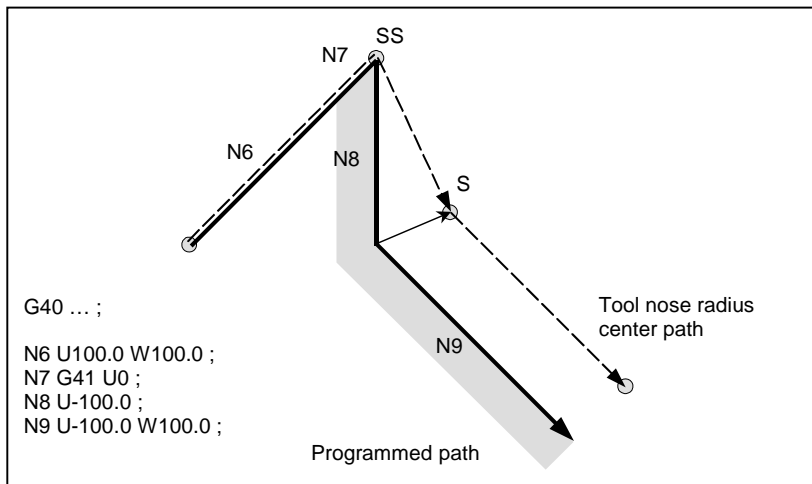

For type C

The tool shifts by the compensation value in the direction vertical to the block with tool movement subsequent to the start-up block.

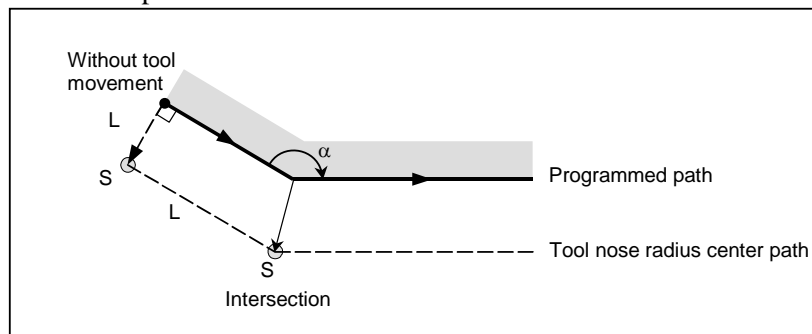

### 5.4.3 Tool Movement in Offset Mode

In offset mode, compensation is performed even for positioning commands, not to speak of linear and circular interpolations. To perform intersection calculation, it is necessary to read at least two blocks with tool movement. If, therefore, two or more blocks with tool movement cannot be read in offset mode because blocks without tool movement, such as auxiliary function independent commands and dwell, are specified in succession, excessive or insufficient cutting may occur because intersection calculation fails. Assuming the number of blocks to read in offset mode, which is determined by parameter No. 19625, to be  $N$  and the number of commands in those  $N$  blocks without tool movement that have been read to be  $M$ , the condition under which intersection calculation is possible is  $(N - 2) \geq M$ . For example, if the maximum number of blocks to read in offset mode is 5, intersection calculation is possible even if up to three blocks without tool movement are specified.

**NOTE**

The condition necessary for an interference check, described later, differs from this condition. For details, see the explanation of the interference check.

If a G or M code in which buffering is suppressed is specified, no subsequent commands can be read before that block is executed, regardless of the setting of parameter No. 19625. Excessive or insufficient cutting may, therefore, occur because of an intersection calculation failure.

- Tool movement around the inside of a corner ( $180^\circ \leq \alpha$ )

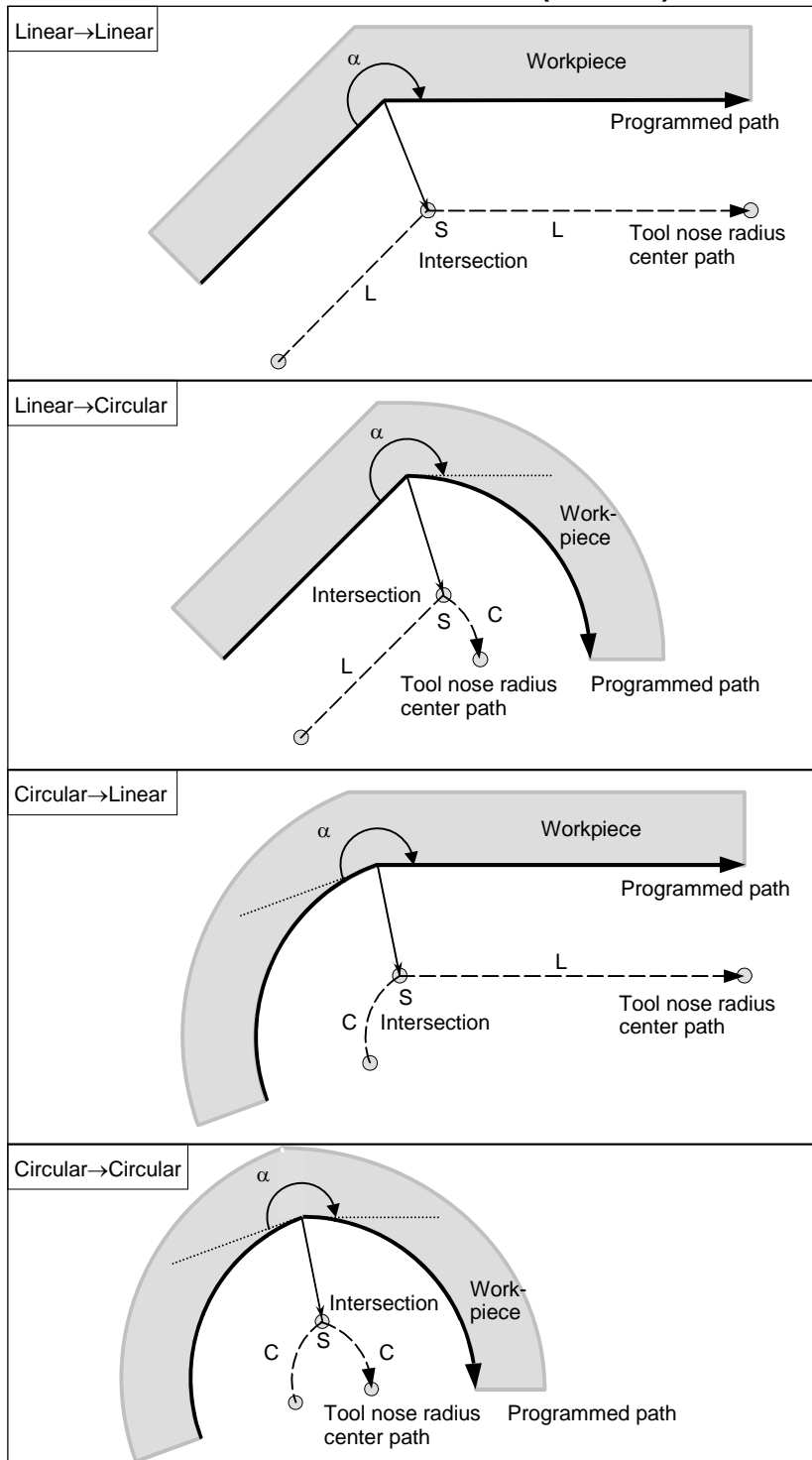

- **Tool movement around the inside ( $\alpha < 1^\circ$ ) with an abnormally long vector, linear  $\rightarrow$  linear**

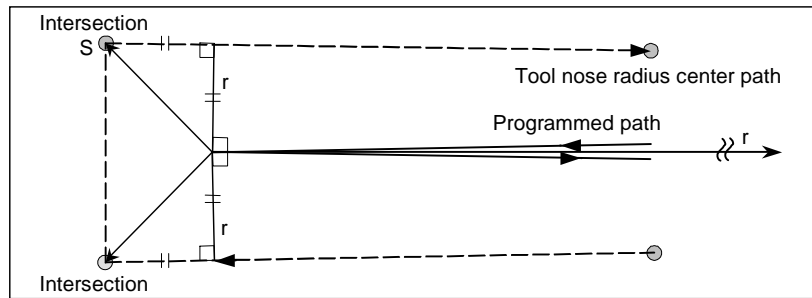

Also in case of arc to straight line, straight line to arc and arc to arc, the reader should infer in the same procedure.

- Tool movement around the outside corner at an obtuse angle ( $90^\circ \leq \alpha < 180^\circ$ )

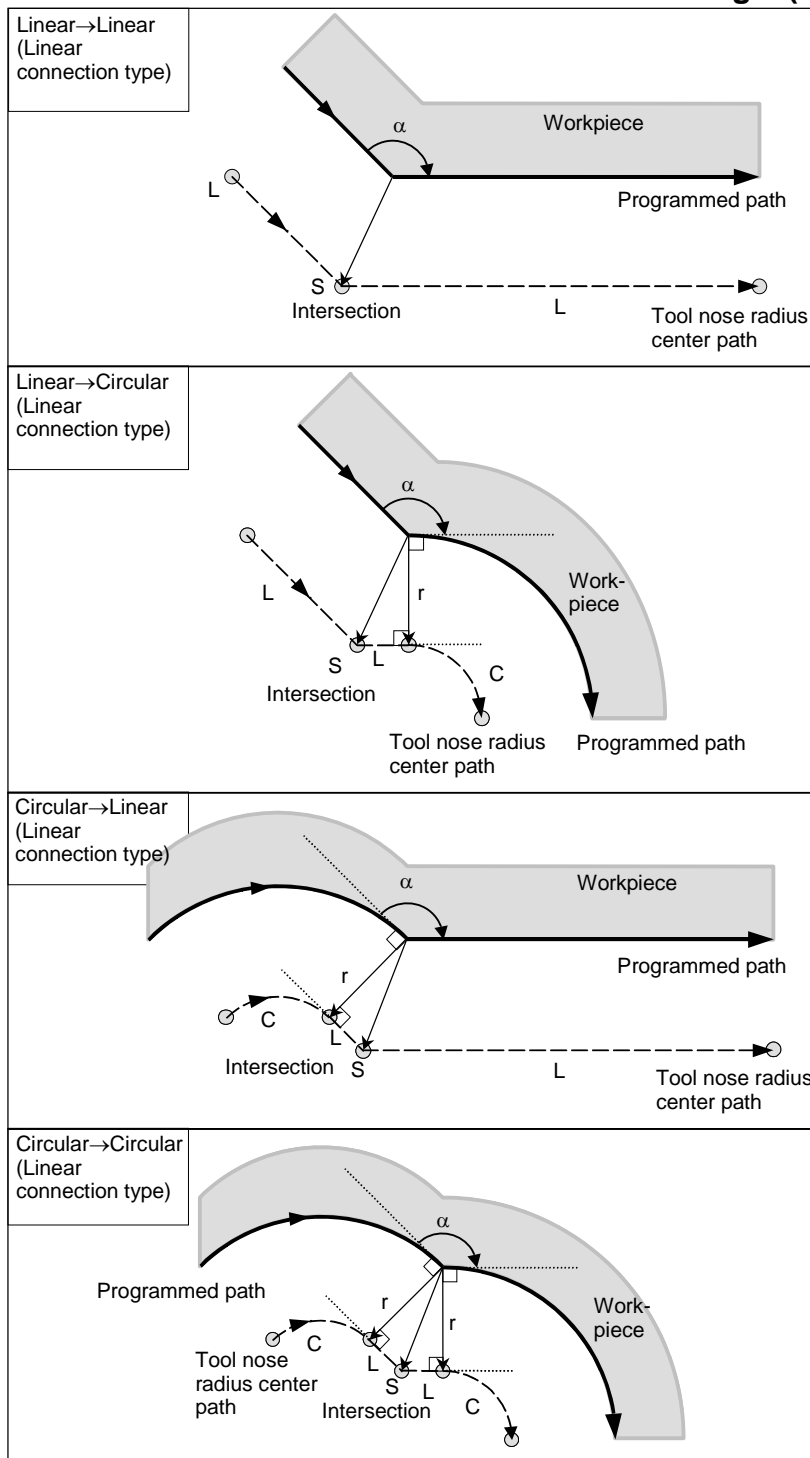

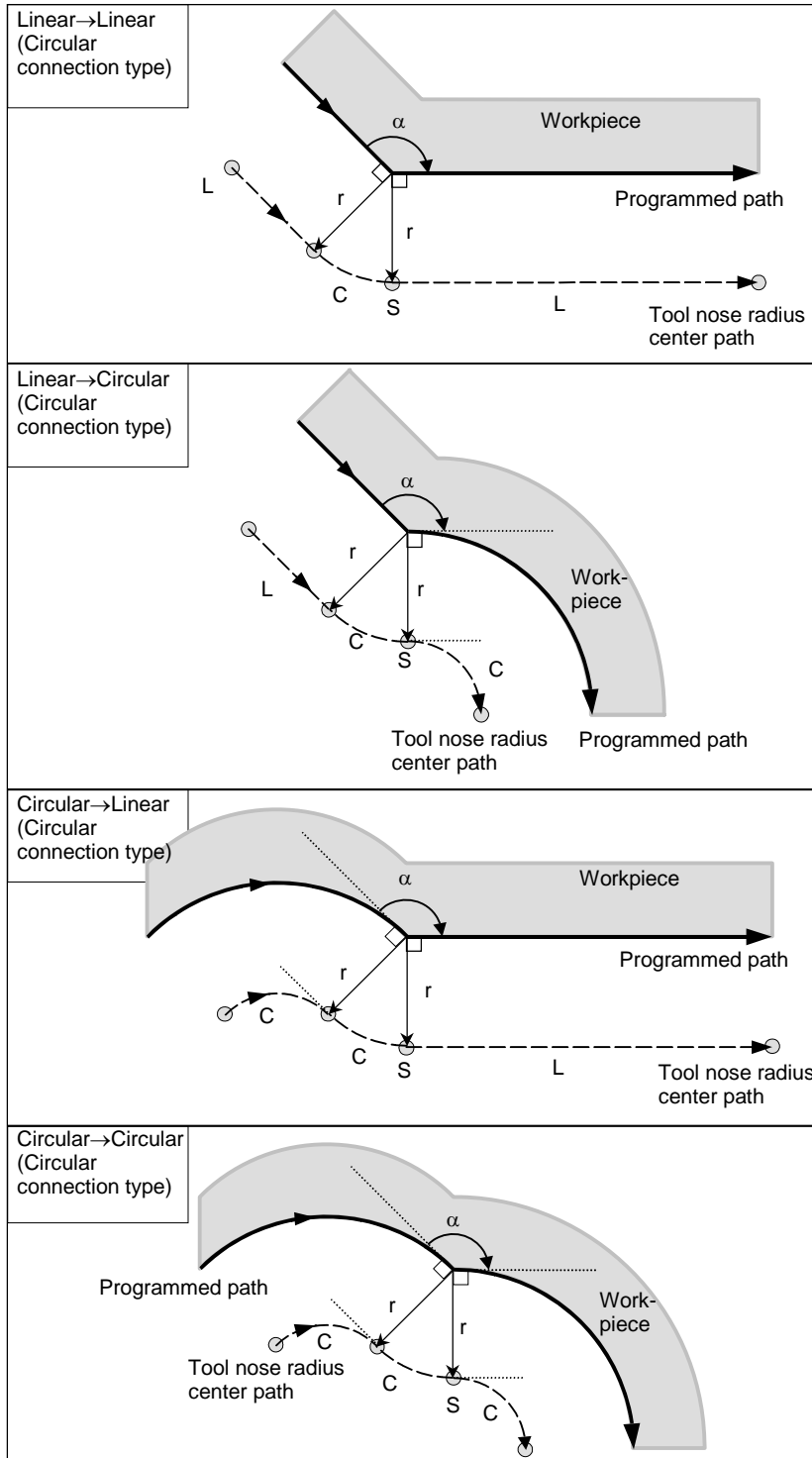

- Tool movement around the outside corner at an acute angle ( $\alpha < 90^\circ$ )

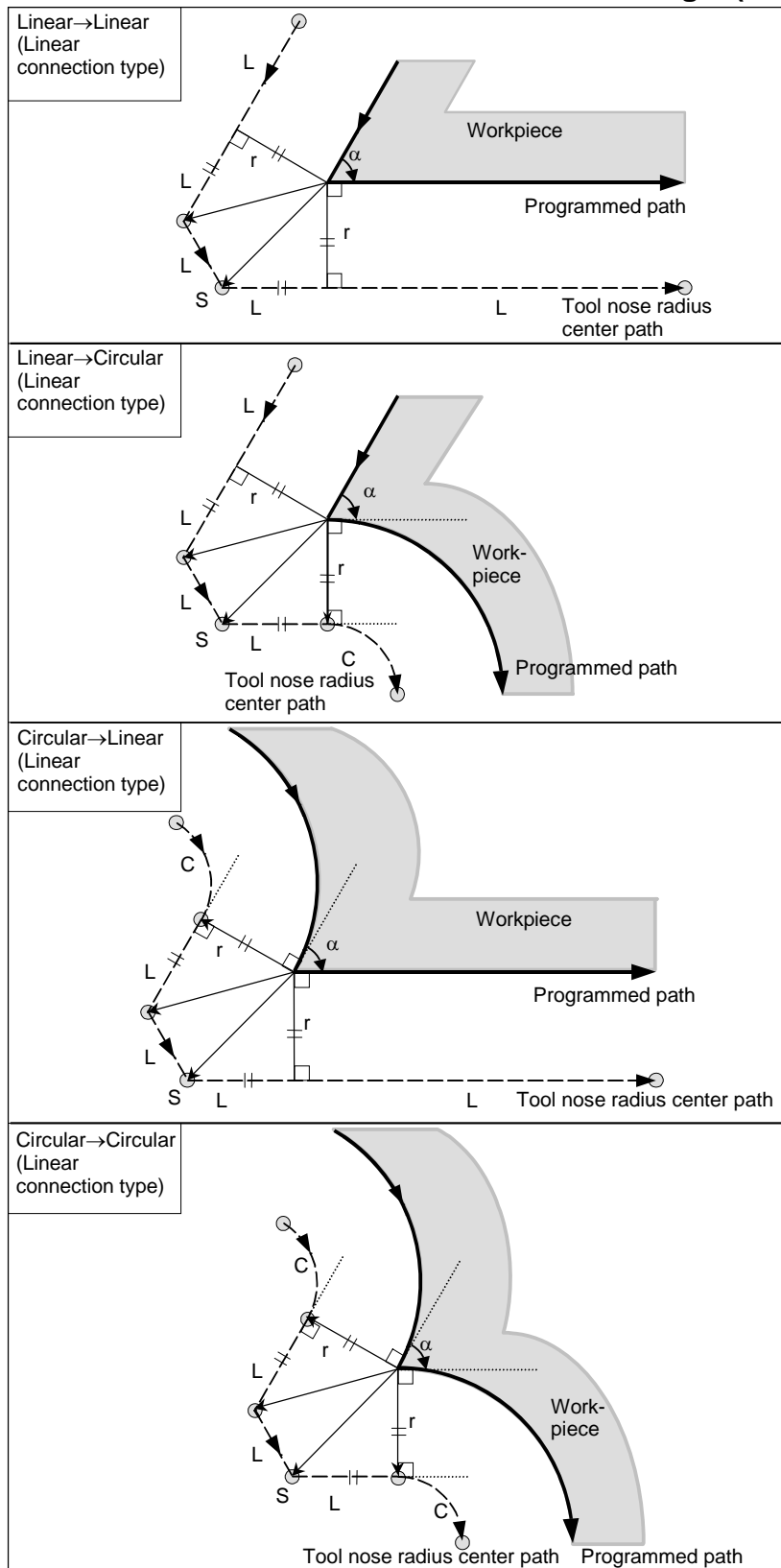



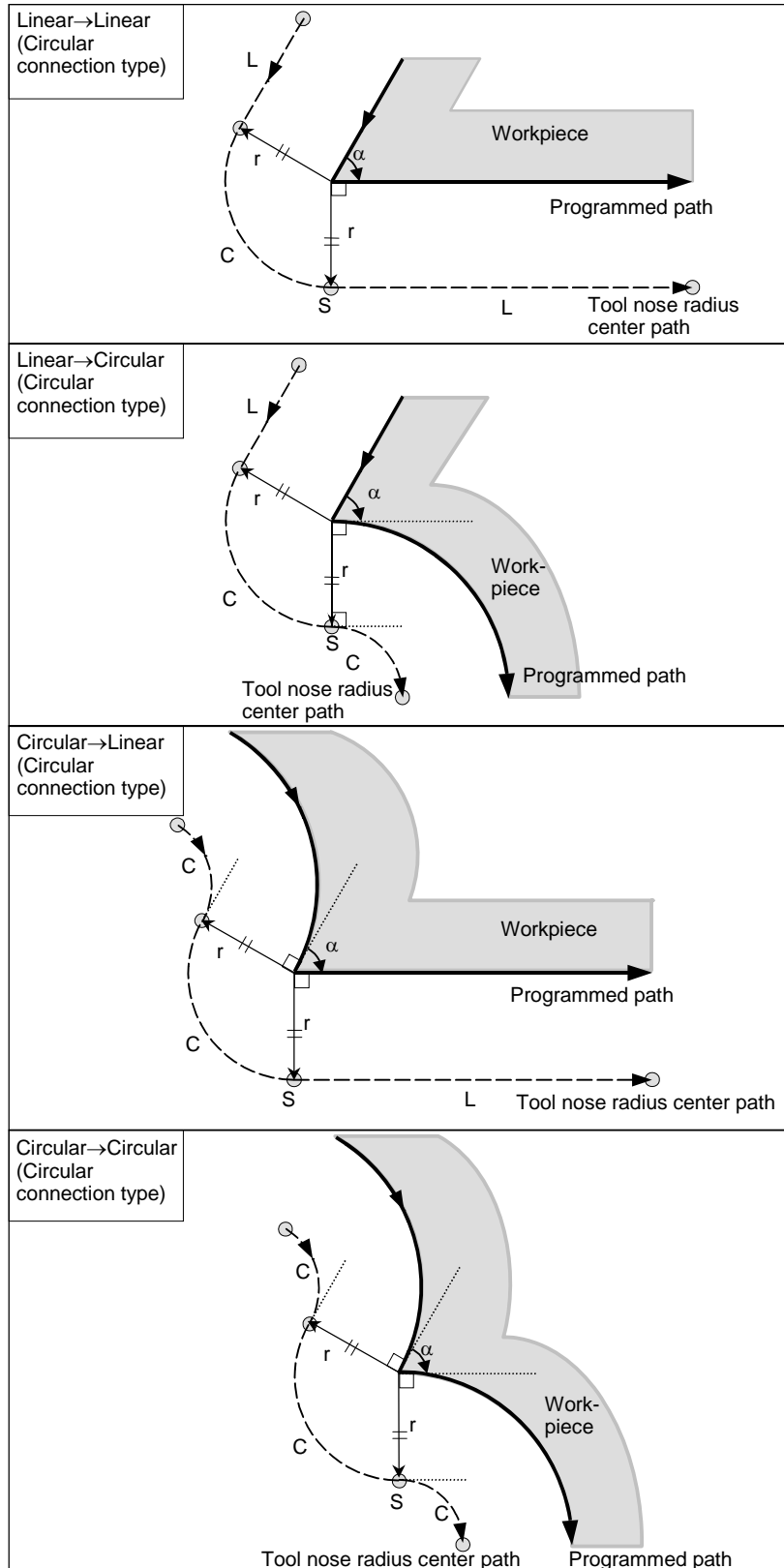

- **When it is exceptional**  
**End position for the arc is not on the arc**

If the end of a line leading to an arc is not on the arc as illustrated below (Fig. 5.4.3 (a)), the system assumes that the tool nose radius compensation has been executed with respect to an imaginary circle that has the same center as the arc and passes the specified end position. Based on this assumption, the system creates a vector and carries out compensation. The same description applies to tool movement between two circular paths.

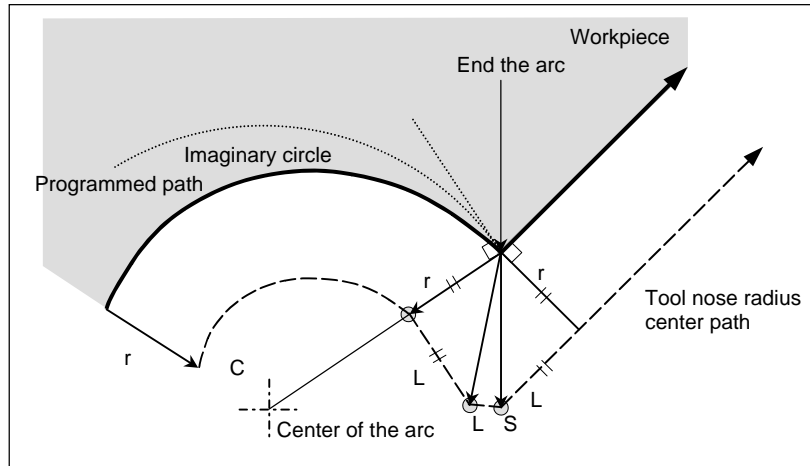

Fig. 5.4.3 (a)

**There is no inner intersection**

If the cutter or tool nose radius compensation value is sufficiently small, the two circular tool center paths made after compensation intersect at a position (P). Intersection P may not occur if an excessively large value is specified for cutter or tool nose radius compensation. When this is predicted, alarm PS0033, "NO INTERSECTION AT CUTTER COMPENSATION" occurs at the end of the previous block and the tool is stopped.

In the example shown Fig. 5.4.3 (b), tool center paths along arcs A and B intersect at P when a sufficiently small value is specified for cutter or tool nose radius compensation. If an excessively large value is specified, this intersection does not occur.

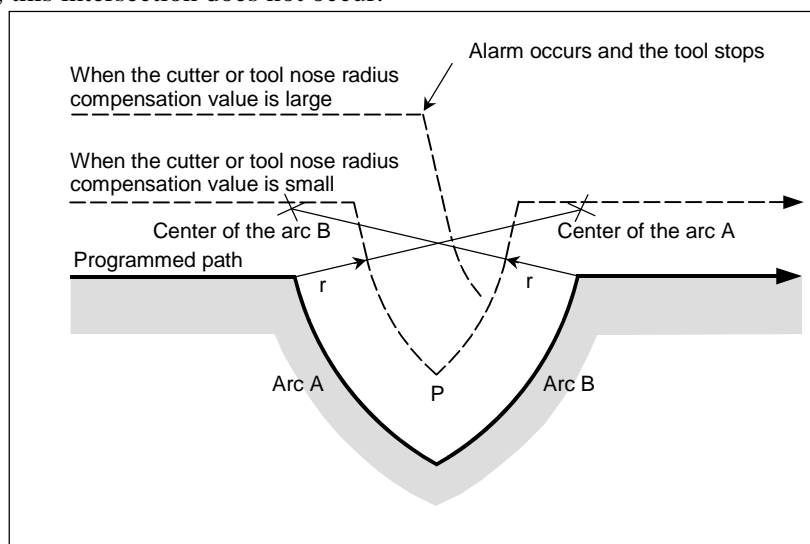
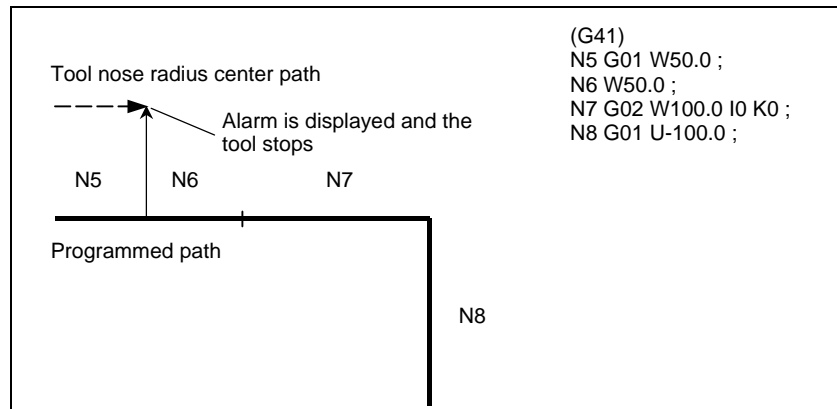

Fig. 5.4.3 (b)

**- When the center of the arc is identical with the start point or the end position**

If the center of the arc is identical with the start point or end point, alarm PS0041, "INTERFERENCE IN CUTTER COMPENSATION" is displayed, and the tool will stop at the start point of the preceding block of the arc.



**- Change in the offset direction in the offset mode**

The offset direction is decided by G codes (G41 and G42) for cutter or tool nose radius compensation and the sign of the compensation value as follows.

| G code | Sign of compensation | +                 | -                |
|--------|----------------------|-------------------|------------------|
|        | G41                  |                   | Left side offset |
| G42    |                      | Right side offset | Left side offset |

The offset direction can be changed in the offset mode. If the offset direction is changed in a block, a vector is generated at the intersection of the tool nose radius center path of that block and the tool nose radius center path of a preceding block.

However, the change is not available in the start-up block and the block following it.

- Tool nose radius center path with an intersection

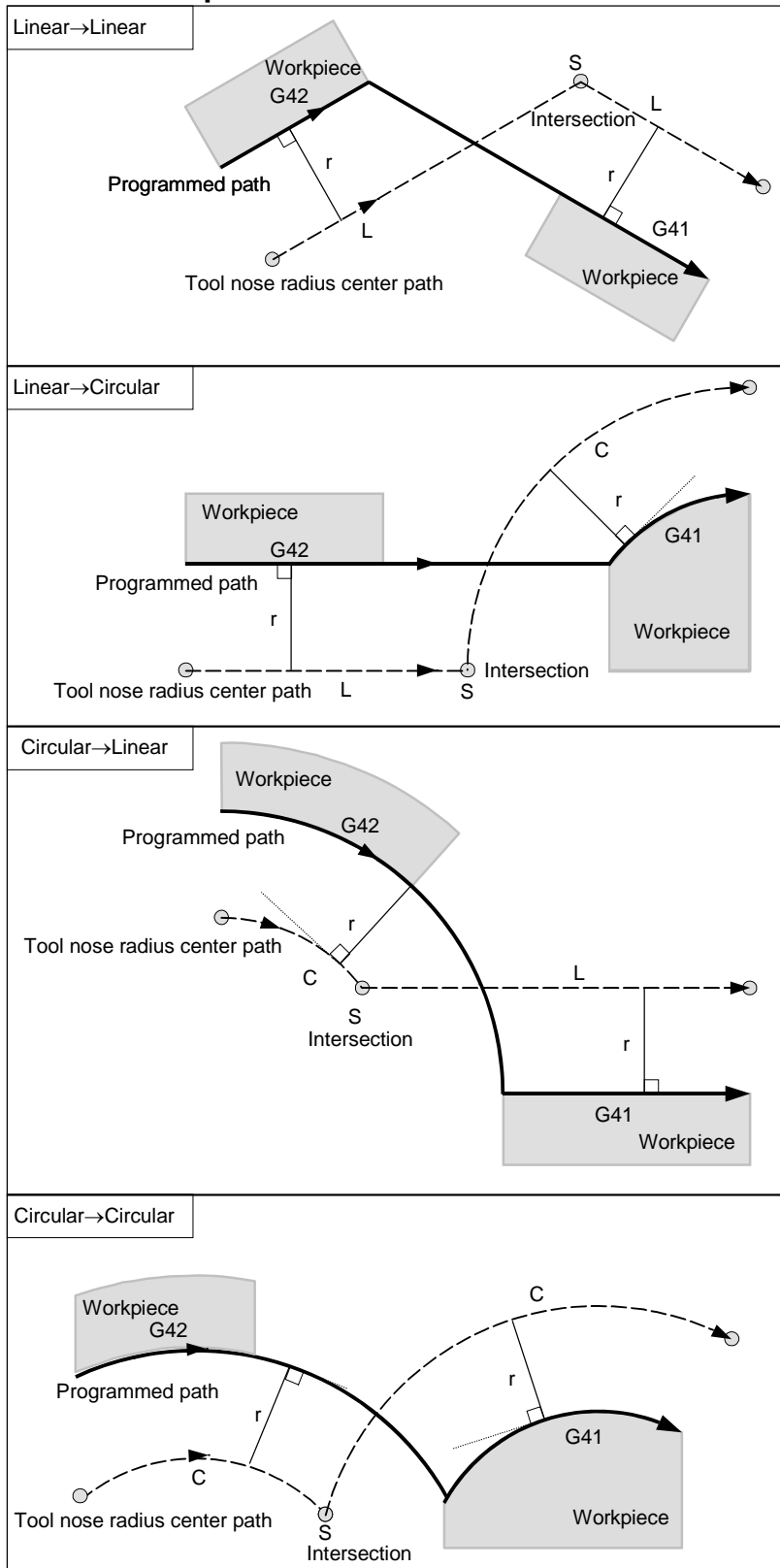

**- Tool nose radius center path without an intersection**

When changing the offset direction in block A to block B using G41 and G42, if intersection with the offset path is not required, the vector normal to block B is created at the start point of block B.

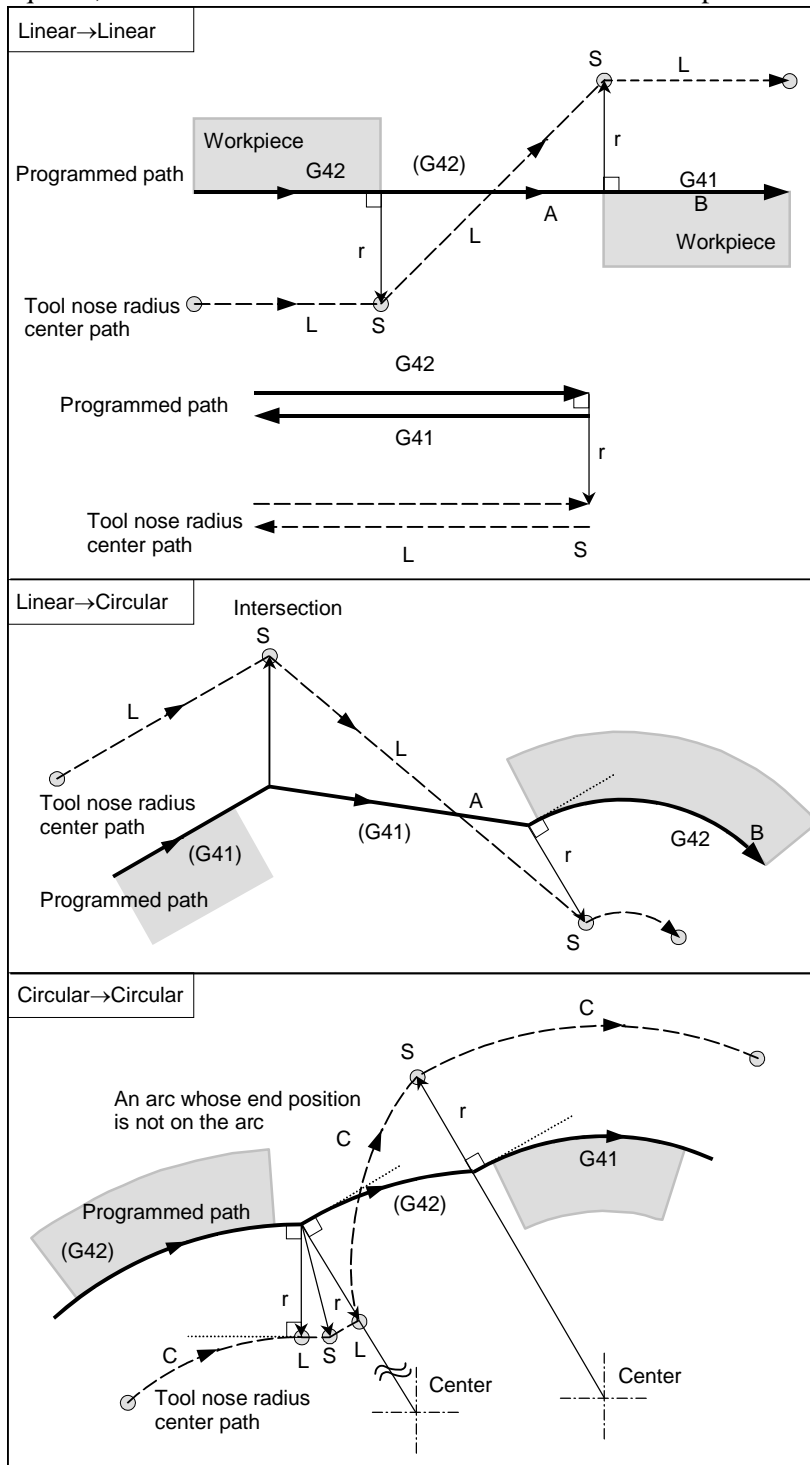

### The length of tool center path larger than the circumference of a circle

Normally there is almost no possibility of generating this situation. However, when G41 and G42 are changed, or when a G40 was commanded with address I, J, and K this situation can occur.

In this case of the Fig. 5.4.3 (c), the cutter compensation is not performed with more than one circle circumference: an arc is formed from P<sub>1</sub> to P<sub>2</sub> as shown. Depending on the circumstances, an alarm may be displayed due to the "Interference Check" described later. To execute a circle with more than one circumference, the circle must be specified in segments.

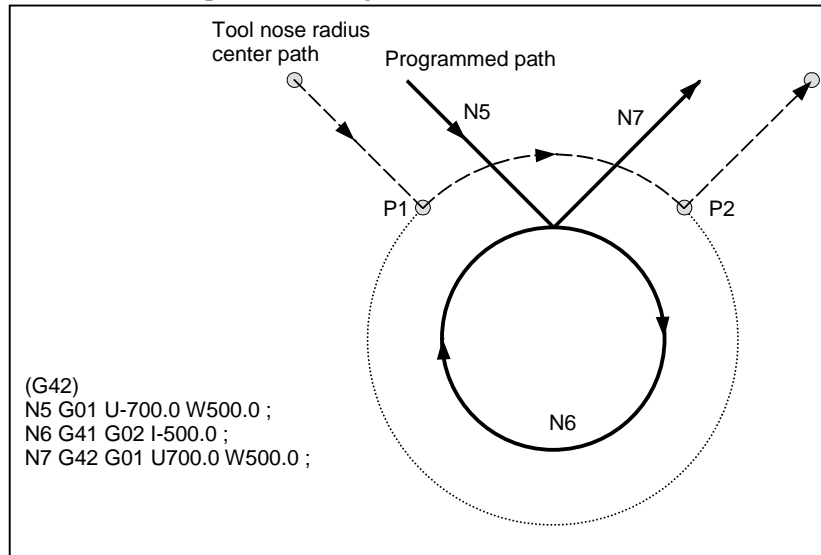
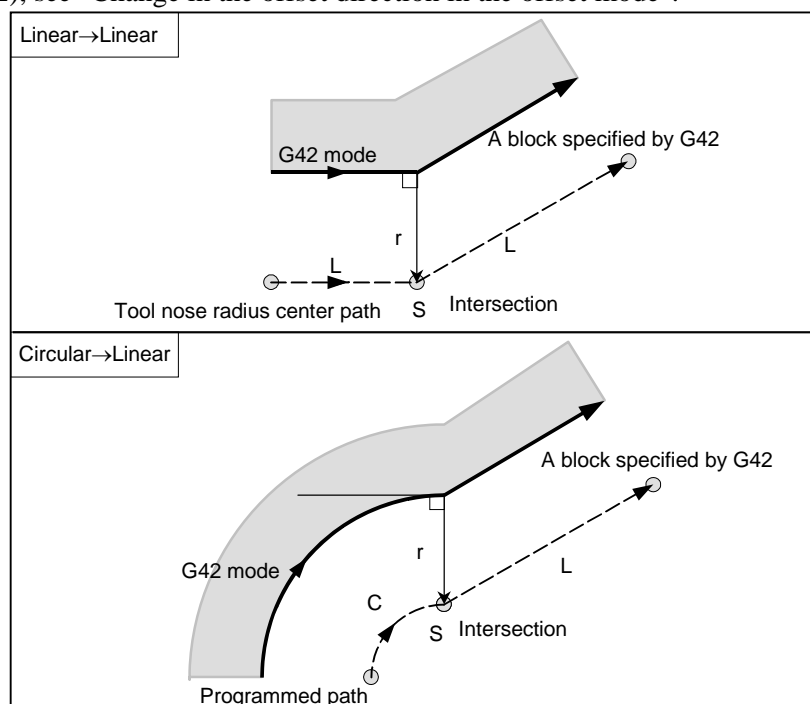

Fig. 5.4.3 (c)

### - Tool nose radius compensation G code in the offset mode

The offset vector can be set to form a right angle to the moving direction in the previous block, irrespective of machining inner or outer side, by commanding the tool nose radius compensation G code (G41, G42) in the offset mode, independently. If this code is specified in a circular command, correct circular motion will not be obtained.

When the direction of offset is expected to be changed by the command of tool nose radius compensation G code (G41, G42), see "Change in the offset direction in the offset mode".



**- Command canceling the offset vector temporarily**

During offset mode, if G50 (workpiece coordinate system setting) or G52 (local coordinate system setting) is commanded, the offset vector is temporarily cancelled and thereafter offset mode is automatically restored.

In this case, without movement of offset cancel, the tool moves directly from the intersecting point to the commanded point where offset vector is canceled.

Also when restored to offset mode, the tool moves directly to the intersecting point.

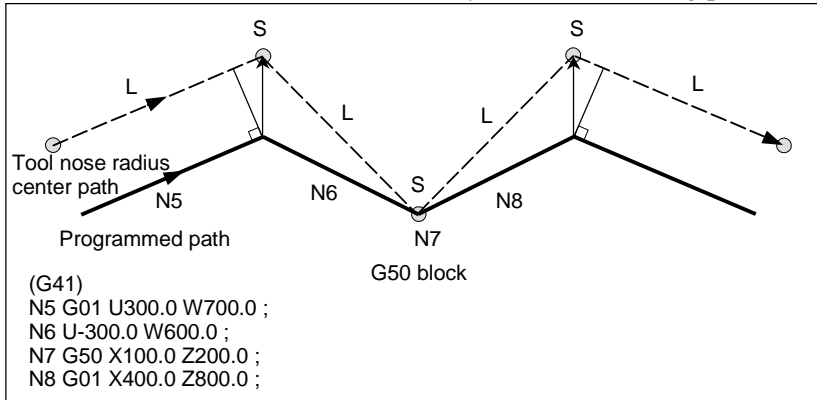

Before specifying G28 (reference position return), G29 (return from reference position), G30 (second, third, and fourth reference position returns), and G53 (machine coordinate system selection) commands, cancel offset mode, using G40. If an attempt is made to specify any of the commands in offset mode, the offset vector temporarily disappears.

**- Canned cycles (G90, G92, G94) and multiple repetitive canned cycles (G71 to G76)**

See the cautions for the tool nose radius compensation related canned cycles.

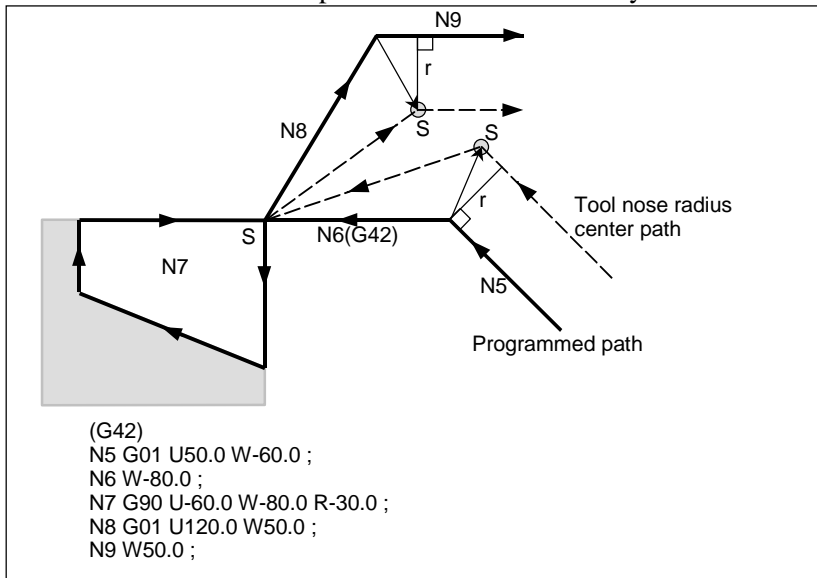

**- If I, J, and K are specified in a G00/G01 mode block**

At the start of tool nose radius compensation or in that mode, by specifying I, J, and K in a positioning mode (G00) or linear interpolation mode (G01) block, it is possible to set the compensation vector at the end point of that block in the direction vertical to that specified by I, J, and K. This makes it possible to change the compensation direction intentionally.

### IJ type vector (XY plane)

The following explains the compensation vector (IJ type vector) to be created on the XY compensation plane (G17 mode). (The same explanation applies to the KI type vector on the G18 plane and the JK type vector on the G19 plane.) As shown in the Fig. 5.4.3 (d) and Fig. 5.4.3 (e), it is assumed that the compensation vector (IJ type vector) is the vector with a size equal to the compensation value and vertical to the direction specified by I and J, without performing intersection calculation on the programmed path. I and J can be specified both at the start of tool nose radius compensation and in that mode. If they are specified at the start of compensation, any start-up type set in the appropriate parameter will be invalid, and an IJ type vector is assumed.

### Offset vector direction

In G41 mode, the direction specified by I, J, and K is assumed an imaginary tool movement direction, and an offset vector is created vertical to that direction and on the left side.

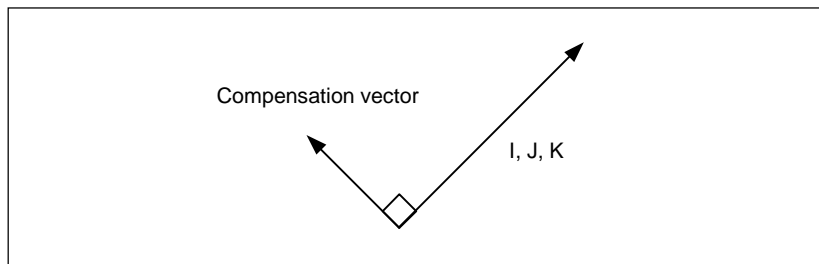

Fig. 5.4.3 (d)

In G42 mode, the direction specified by I, J, and K is assumed an imaginary tool movement direction, and an offset vector is created vertical to that direction and on the right side.

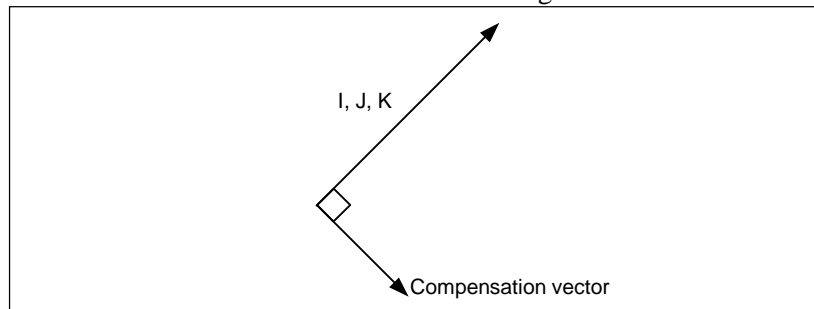

Fig. 5.4.3 (e)

## Example

|   |                                     |
|---|-------------------------------------|
| <p>If I and J are specified at the start of compensation (with tool movement)</p> <pre>(G40) N10 G41 U100.0 W100.0       K1 T0101 ; N20 G04 X1000 ; N30 G01 F1000 ; N40 S300 ; N50 M50 ; N60 W150.0 ;</pre> <p>Note) In N10, a vector is specified with a size of T1 in the direction vertical to the Z axis, using K1.</p> | <pre>N50 N40 N30 N20      N60</pre> |
|---|-------------------------------------|



If I and J are specified at the start of compensation (without tool movement)

```

(G40)
N10 G41 K1 T0101 ;
N20 U100.0 W100.0 ;
N30 W150.0 ;
    
```

Note) In N10, a vector is specified with a size of T1 in the direction vertical to the Z axis, using K1.

If I and J are specified at the start of compensation (with tool movement)

```

(G17 G41 T0101)
N10 G00 U150.0 J50.0 ;
N20 G02 I50.0 ;
N30 G00 U-150.0 ;
    
```

Note) In N10, a vector is specified with a size of T1 in the direction vertical to the Y axis, using J50.0.

<1> IJ type vector  
 <2> Vector determined with intersection calculation

----- Tool center path  
 \_\_\_\_\_ Programmed path  
 ----- Path determined with intersection calculation

If I and J are specified in a block without tool movement in compensation mode

Start-up/cancel type C

```

N10 G41 T0101 G01 F1000 ;
N20 U100.0 W100.0 ;
N30 K10.0 ;
N40 W150.0 ;
N50 G40 ;
    
```

**Limitation**

If an IJ type vector is specified, tool interference may occur due to that vector alone, depending on the direction. If this occurs, no interference alarm will occur, or no interference avoidance will be performed. Overcutting may, therefore, result.

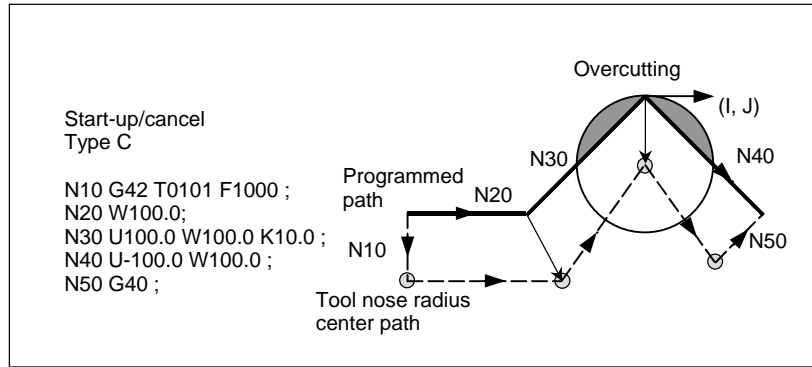

**- A block without tool movement**

The following blocks have no tool movement. In these blocks, the tool will not move even if cutter compensation is effected.

|                         |  |
|-------------------------|--|
| M05 ;                   | : M code output  |
| S21 ;                   | : S code output  |
| G04 X10.0 ;             | : Dwell  |
| G22 X100000 ;           | : Machining area setting                               |
| G10 P01 X10 Z20 R10.0 ; | : Tool nose radius compensation value setting/changing |
| (G18) Y200.0 ;          | : Move command not included in the offset plane.       |
| G98 ;, O10 ;, N20 ;     | : G, O, and N codes only                               |
| U0 ;                    | : Move distance is zero.                               |

**- A block without tool movement specified in offset mode**

Unless the number of blocks without movement consecutively specified is more than N-2 blocks (where N is the number of blocks to read in offset mode (parameter No. 19625)) in offset mode, the vector and the tool nose radius center path will be as usual. This block is executed at the single block stop point.

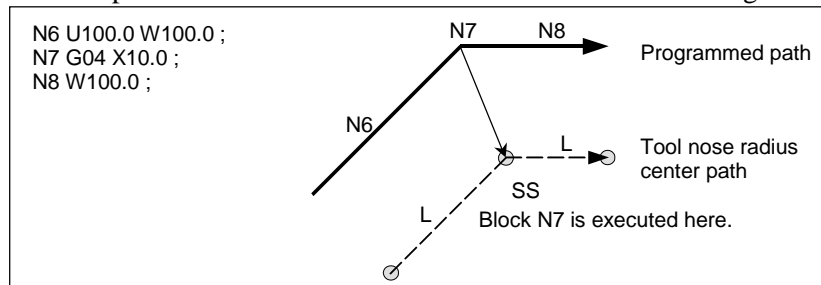

In offset mode, the number of blocks without movement consecutively specified must not exceed N-2 (where N is the number of blocks to read in offset mode (parameter No. 19625)). If commanded, a vector whose length is equal to the offset value is produced in a normal direction to tool motion in earlier block, so overcutting may result.

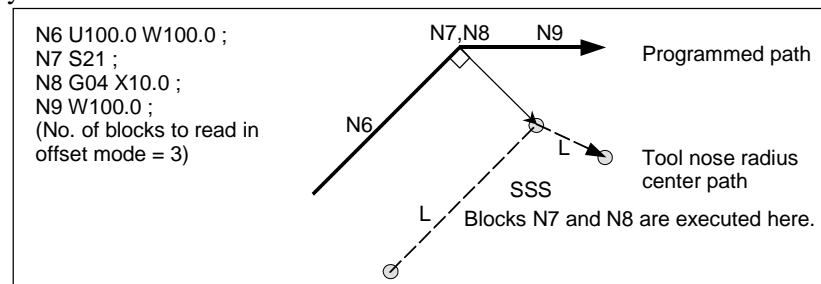

**- If an M/G code that suppresses buffering is specified**

If an M/G code that suppresses buffering is specified in offset mode, it is no longer possible to read and analyze subsequent blocks regardless of the number of blocks to read in offset mode, which is determined by parameter No. 19625.

Then, intersection calculation and an interference check, described later, are no longer possible. If this occurs, overcutting may occur because a vertical vector is output in the immediately preceding block.

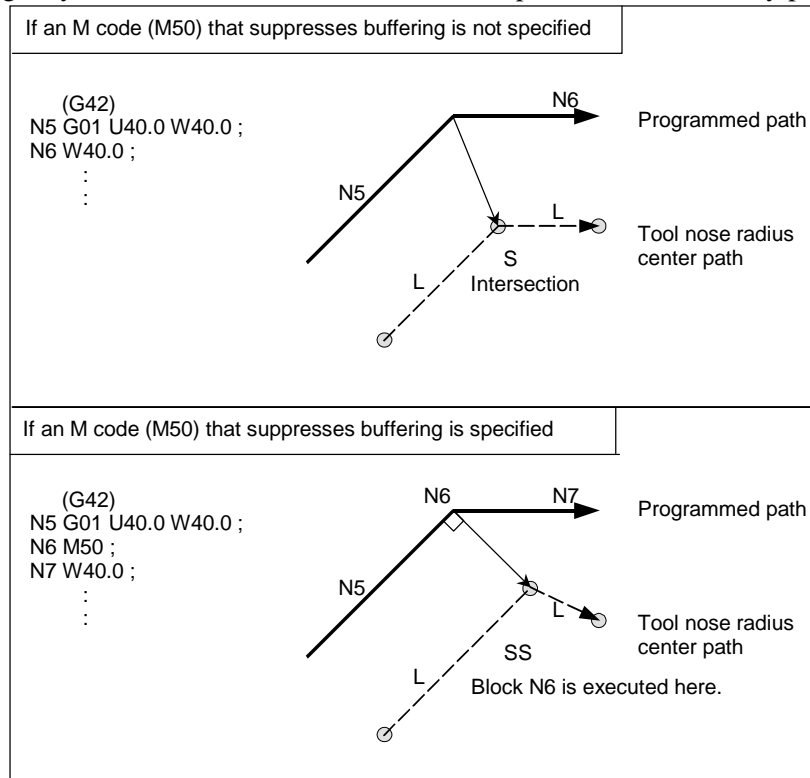

#### - Workpiece coordinate system or local coordinate system command in the offset mode

If the local coordinate system (G52) or workpiece coordinate system (G50) is specified in the tool nose radius compensation (G41 or G42) mode, G52 or G50 is assumed to be a buffering masked G code. The subsequent blocks are not executed until the G52 or G50 block is executed.

#### - Corner movement

When two or more offset vectors are produced at the end of a block, the tool moves linearly from one vector to another. This movement is called the corner movement.

If these vectors almost coincide with each other (the distance of corner movement between the vectors is judged short due to the setting of parameter No. 5010), corner movement is not performed. In this case, the vector to the single block stop point takes precedence and remains, while other vectors are ignored. This makes it possible to ignore the very small movements arising from performing tool nose radius compensation, thereby preventing velocity changes due to interruption of buffering.

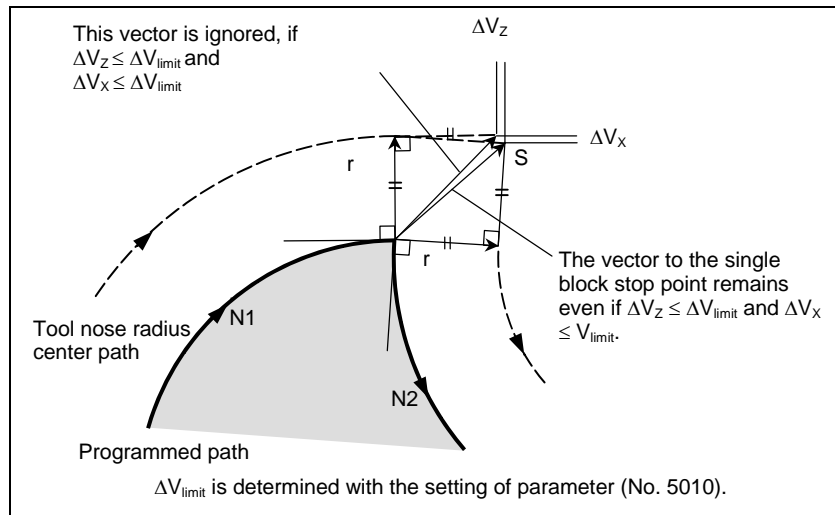

If the vectors are not judged to almost coincide (therefore, are not erased), movement to turn around the corner is performed. The corner movement that precedes the single block stop point belongs to the previous block, while the corner movement that succeeds the single block stop point belongs to the latter block.

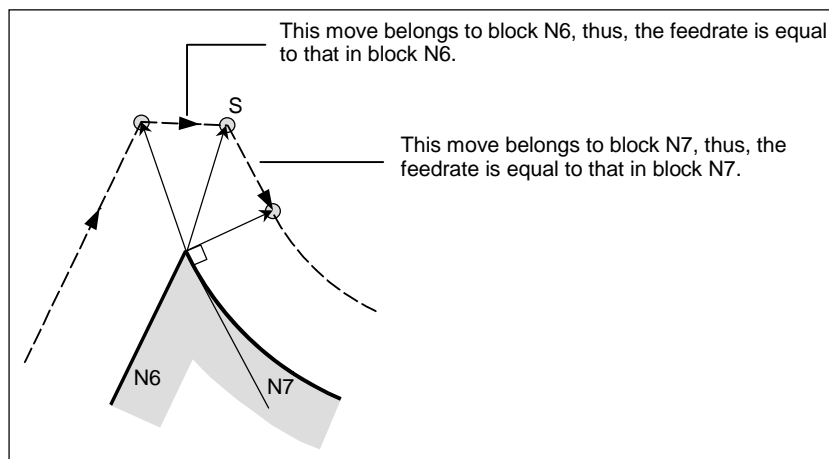

However, if the path of the next block is semicircular or more, the above function is not performed. The reason for this is as follows:

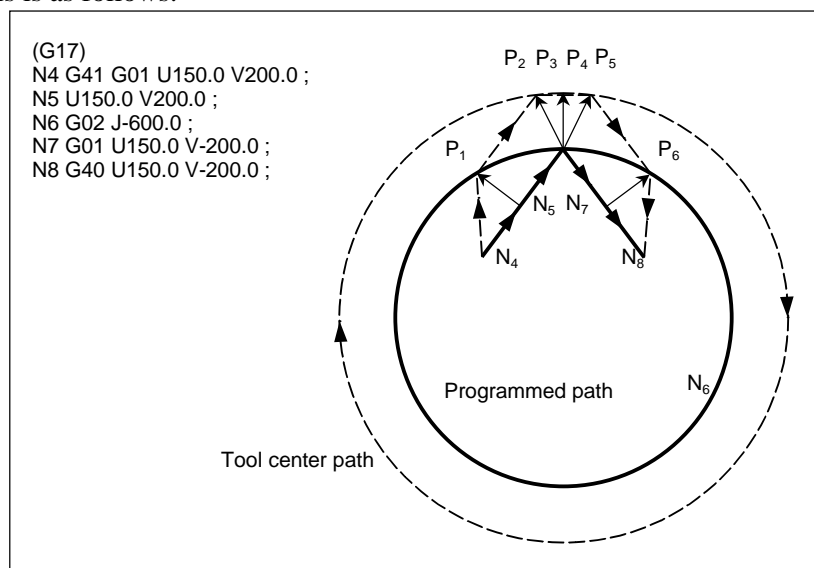

If the vector is not ignored, the tool path is as follows:

$P_1 \rightarrow P_2 \rightarrow P_3 \rightarrow (\text{Circle}) \rightarrow P_4 \rightarrow P_5 \rightarrow P_6$

But if the distance between  $P_2$  and  $P_3$  is negligible, the point  $P_3$  is ignored. Therefore, the tool path is as follows:

$P_2 \rightarrow P_4$

Namely, circle cutting by the block N6 is ignored.

**- Interruption of manual operation**

For manual operation during the offset mode, see "Manual Absolute ON and OFF."

## 5.4.4 Tool Movement in Offset Mode Cancel

### Explanation

- If the cancel block is a block with tool movement, and the tool moves around the inside ( $180^\circ \leq \alpha$ )

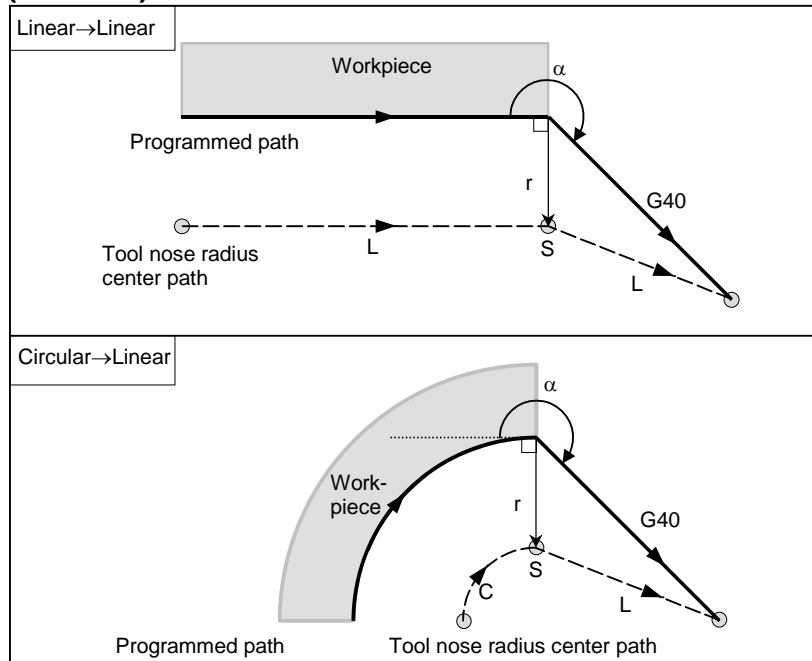
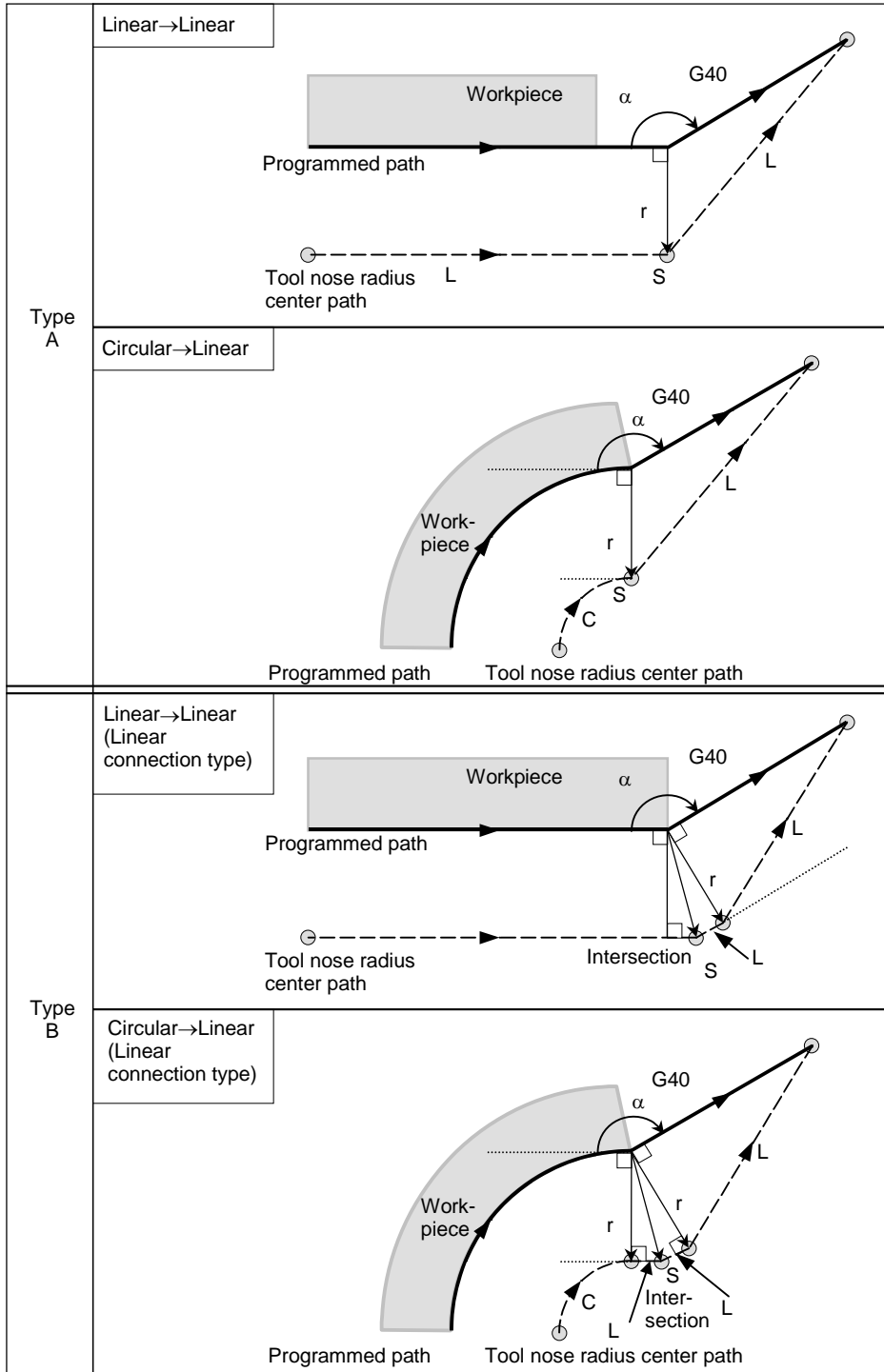

Fig. 5.4.4 (a)

- If the cancel block is a block with tool movement, and the tool moves around the outside at an obtuse angle ( $90^\circ \leq \alpha < 180^\circ$ )



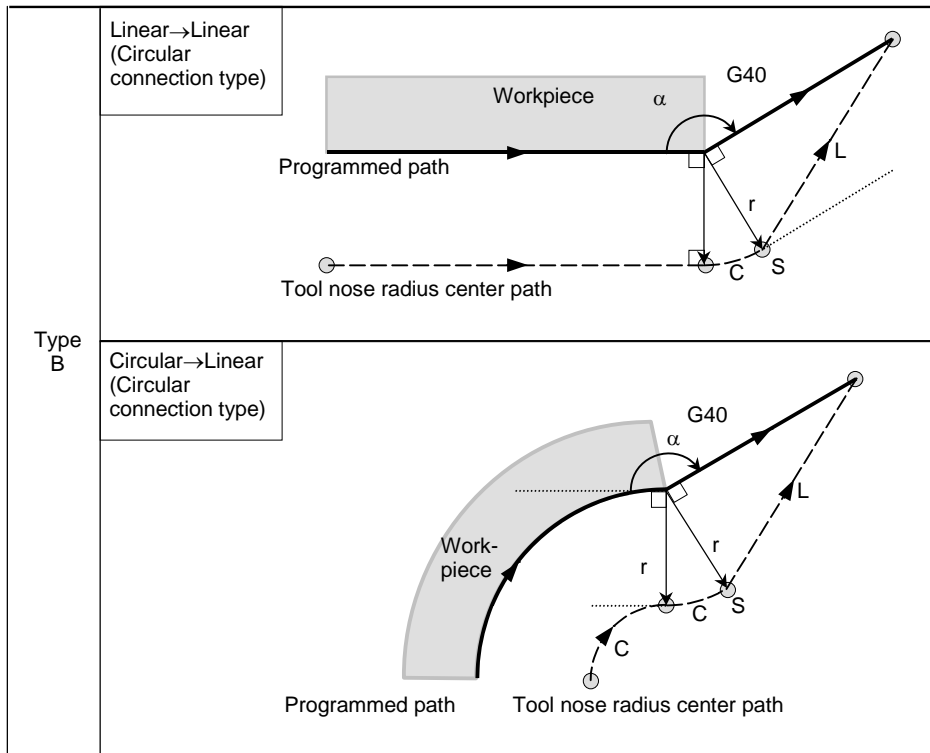
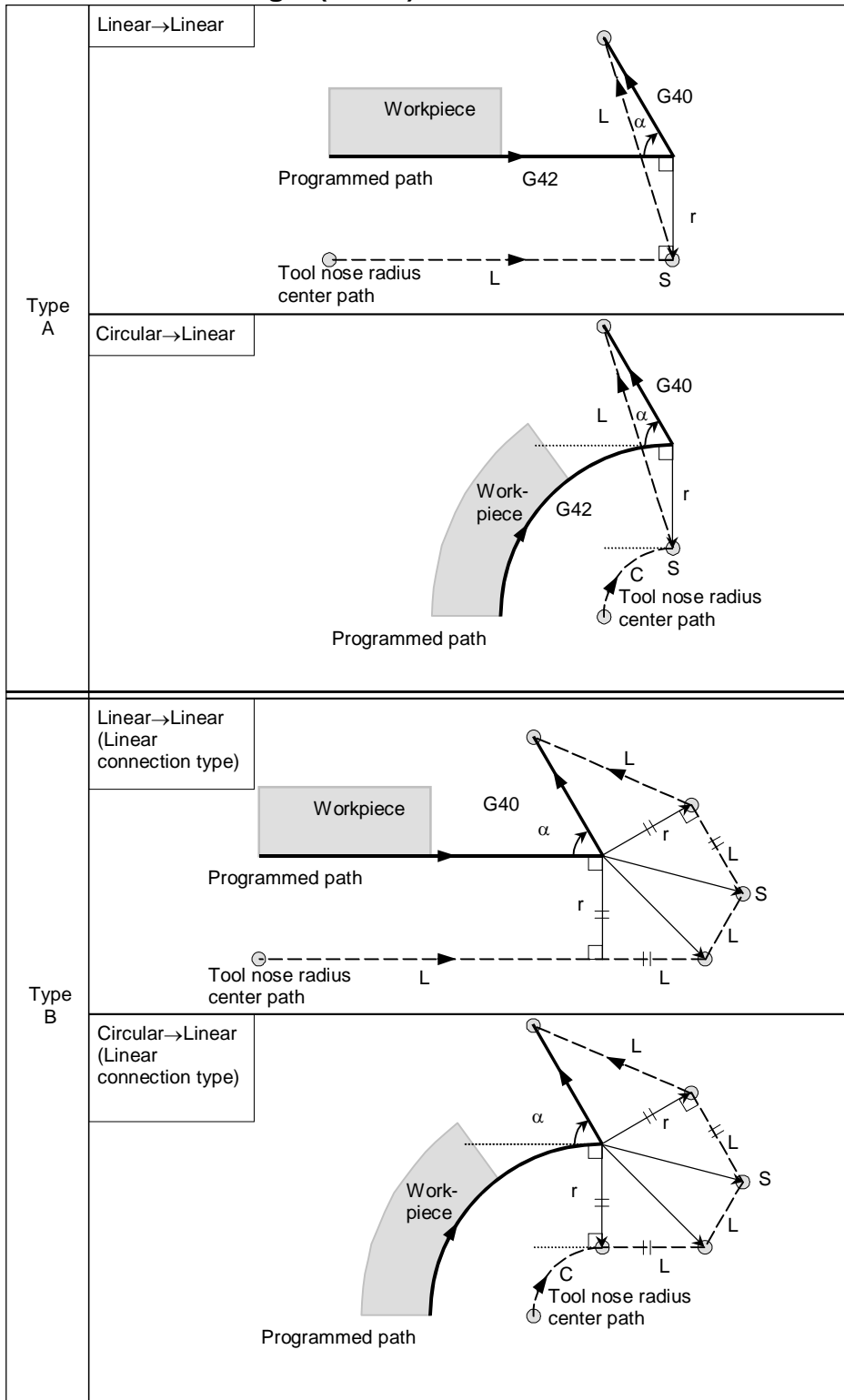

Fig. 5.4.4 (b)



- If the cancel block is a block with tool movement, and the tool moves around the outside at an acute angle ( $\alpha < 90^\circ$ )



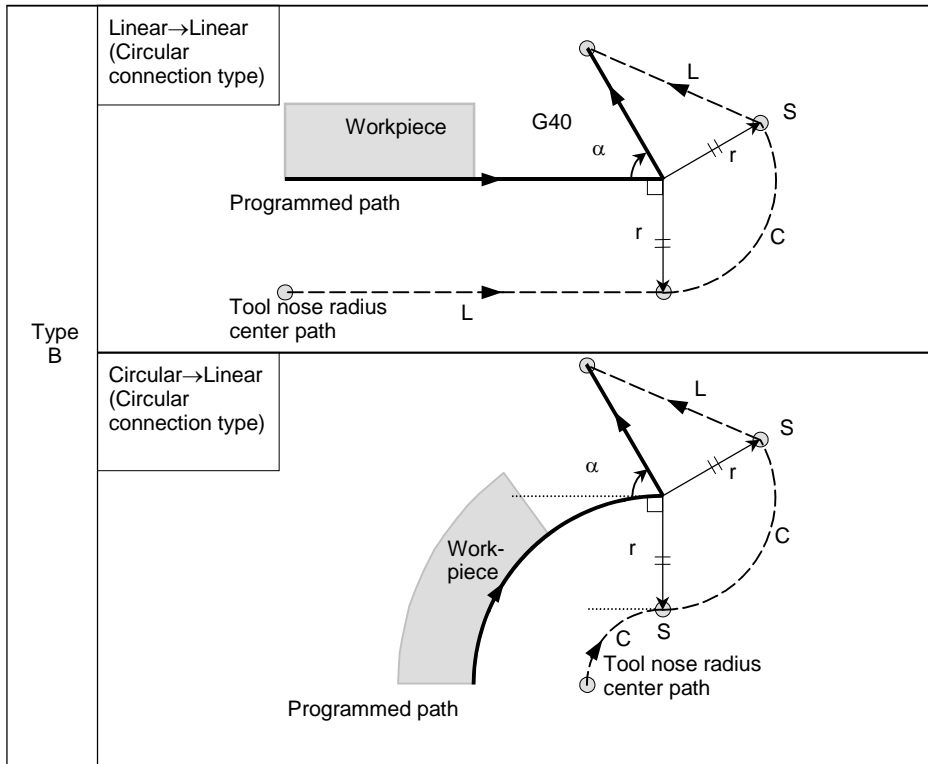

Fig. 5.4.4 (c)

- If the cancel block is a block with tool movement, and the tool moves around the outside at an acute angle of 1 degree or less in a linear to linear manner ( $\alpha \leq 1^\circ$ )

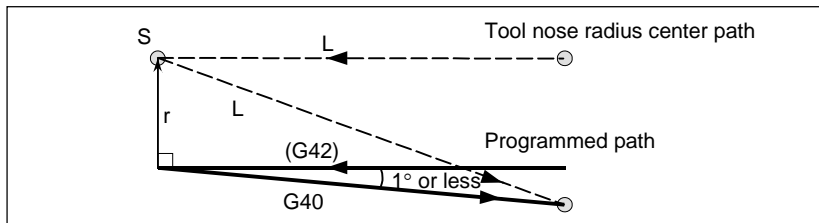

Fig. 5.4.4 (d)

- A block without tool movement specified together with offset cancel

For types A and B

In the block preceding the cancel block, a vector is created with a size equal to the cutter or tool nose radius compensation value in the vertical direction. The tool does not operate in the cancel block. The remaining vectors are canceled with the next move command.

The compensation plane cannot be switched without canceling the remaining vector.

If the compensation plane (G17,G18,G19) is switched without canceling the remaining vector, the alarm PS0037, "CAN NOT CHANGE PLANE IN G41/G42" is occurred.

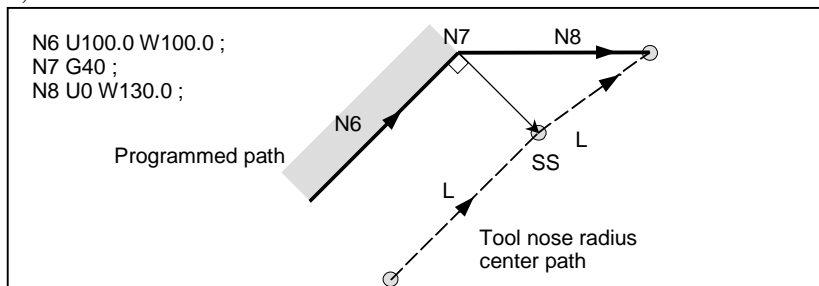

Fig. 5.4.4 (e)

For type C

The tool shifts by the compensation value in the direction vertical to the block preceding the cancel block.

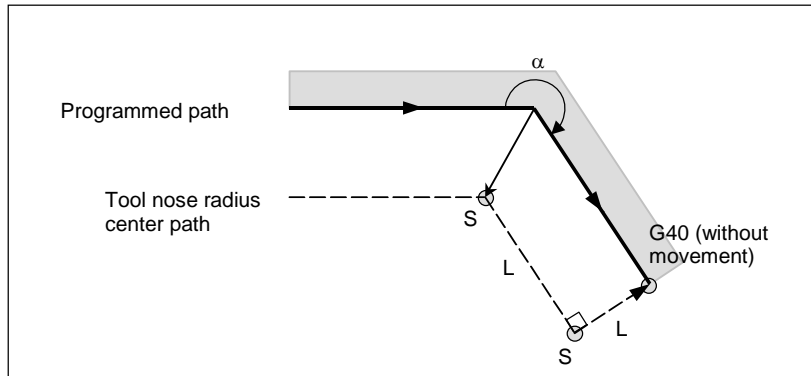

Fig. 5.4.4 (f)

**- Block containing G40 and I\_ J\_ K\_**  
**The previous block contains G41 or G42**

If a G41 or G42 block precedes a block in which G40 and I\_ J\_ K\_ are specified, the system assumes that the path is programmed as a path from the end position determined by the former block to a vector determined by (I,J), (I,K), or (J,K). The direction of compensation in the former block is inherited.

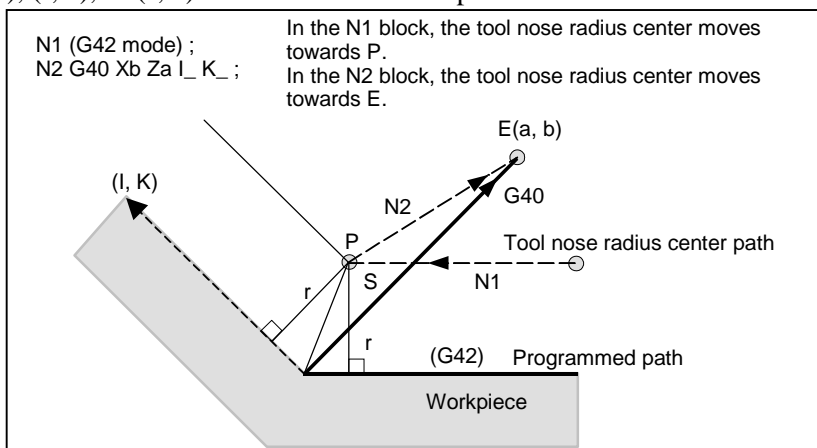

Fig. 5.4.4 (g)

In this case, note that the CNC obtains an intersection of the tool path irrespective of whether inner or outer side machining is specified.

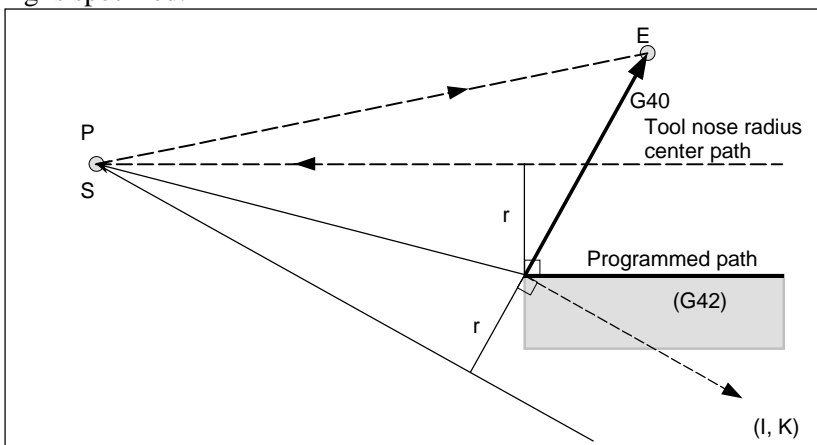

Fig. 5.4.4 (h)

When an intersection is not obtainable, the tool comes to the normal position to the previous block at the end of the previous block.

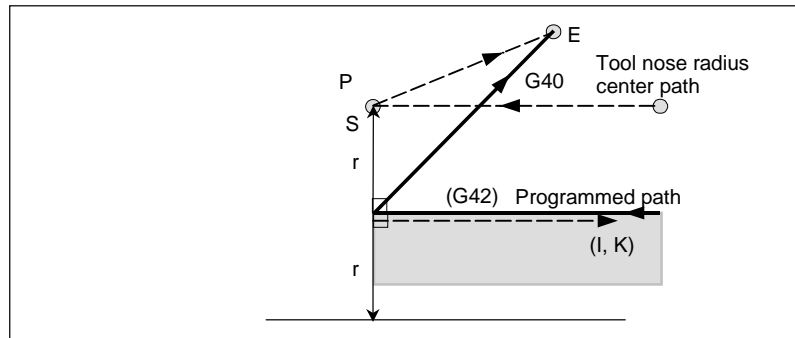

Fig. 5.4.4 (i)

#### - Length of the tool center path larger than the circumference of a circle

In the example shown below, the tool does not trace the circle more than once. It moves along the arc from  $P_1$  to  $P_2$ . The interference check function described below may raise an alarm.

To make the tool trace a circle more than once, program two or more arcs.

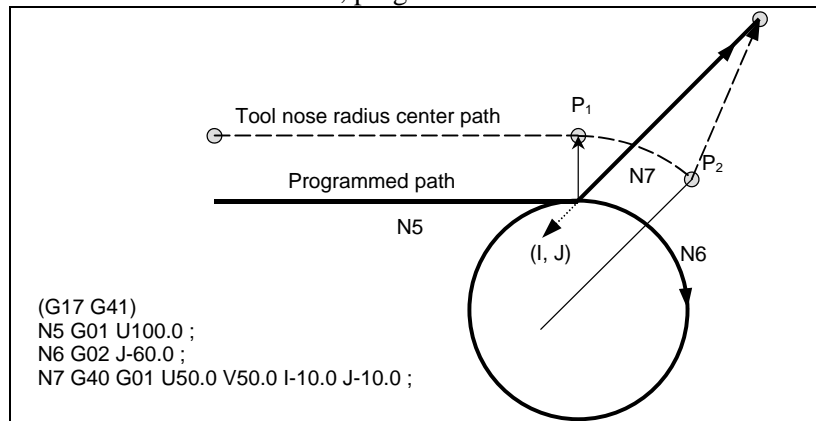

Fig. 5.4.4 (j)

## 5.4.5 Prevention of Overcutting Due to Cutter or Tool Nose Radius Compensation

### Explanation

#### - Machining a groove smaller than the diameter of the tool nose

Since the tool nose radius compensation forces the path of the center of the tool nose radius to move in the reverse of the programmed direction, overcutting will result. In this case an alarm is displayed and the CNC stops at the start of the block.

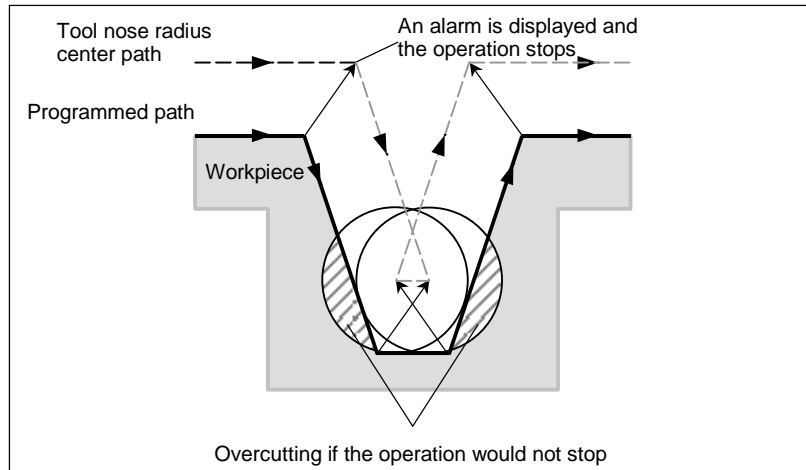

Fig. 5.4.5 (a) Machining a groove smaller than the diameter of the tool nose

#### - Machining a step smaller than the tool nose radius

For a figure in which a workpiece step is specified with an arc, the tool nose radius center path will be as shown in Fig. 5.4.5 (b). If the step is smaller than the tool nose radius, the tool nose radius center path usually compensated as shown in Fig. 5.4.5 (c) may be in the direction opposite to the programmed path. In this case, the first vector is ignored, and the tool moves linearly to the second vector position. The single block operation is stopped at this point. If the machining is not in the single block mode, the cycle operation is continued.

If the step is of linear, no alarm will be generated and cut correctly. However uncut part will remain.

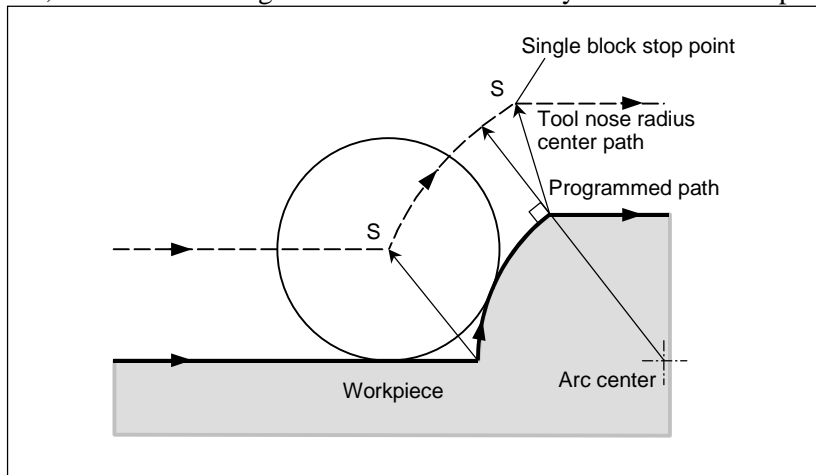

Fig. 5.4.5 (b) Machining a step larger than the tool nose radius

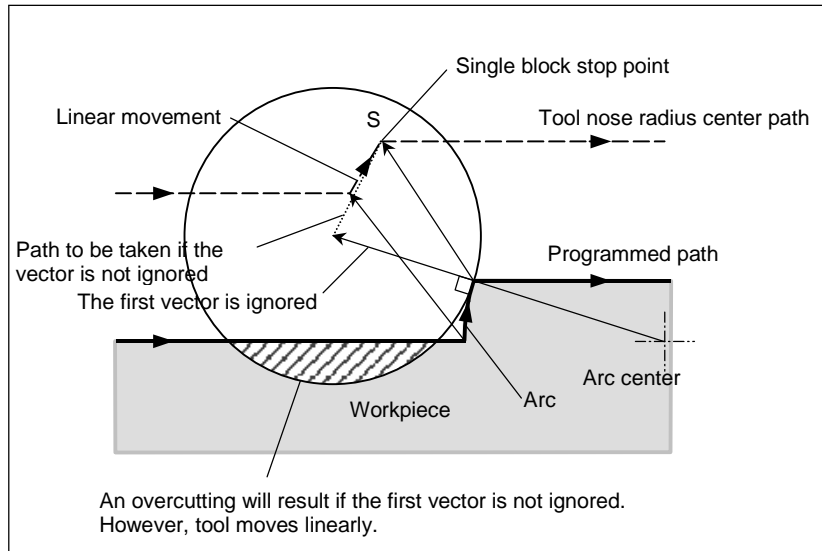

Fig. 5.4.5 (c) Machining a step smaller than the tool nose radius

### - Starting compensation and cutting along the Z-axis

It is usually used such a method that the tool is moved along the Z axis after the cutter compensation (normally XY plane) is effected at some distance from the workpiece at the start of the machining. In the case above, if it is desired to divide the motion along the Z axis into rapid traverse and cutting feed, follow the procedure below.

Let us consider the following program, assuming the number of blocks to read in cutter compensation mode (parameter No. 19625) to be 3.

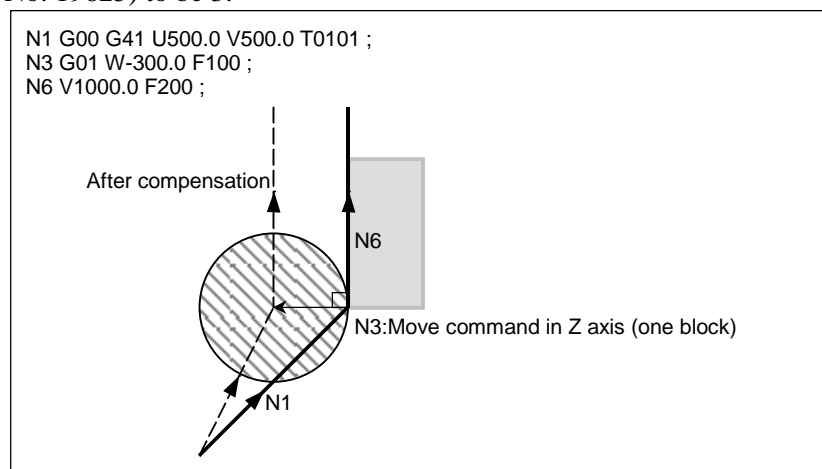

Fig. 5.4.5 (d)

In the program example above (Fig. 5.4.5 (d)), when executing block N1, blocks N3 and N6 are also entered into the buffer storage, and by the relationship among them the correct compensation is performed as in the Fig. 5.4.5 (d).

Then, suppose that the block N3 (move command in Z axis) is divided into N3 and N5.

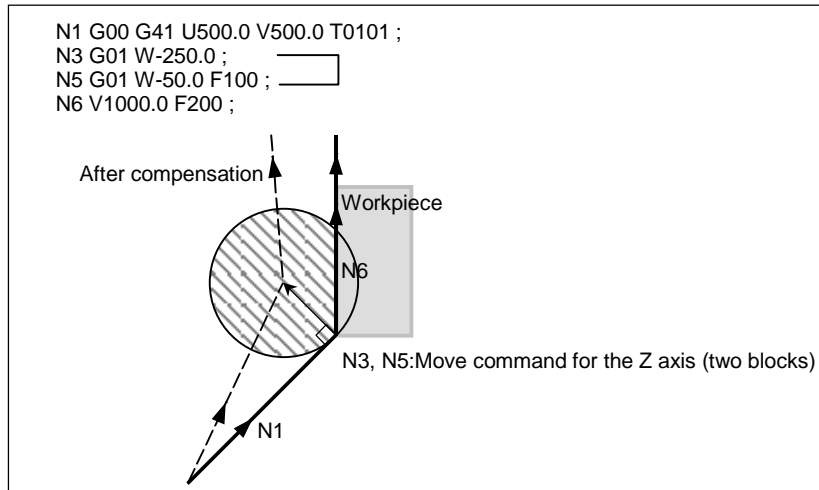

Fig. 5.4.5 (e)

At this time, because the number of blocks to read is 3, blocks up to N5 can be read at the start of N1 compensation, but block N6 cannot be read. As a result, compensation is performed only on the basis of the information in block N1, and a vertical vector is created at the end of the compensation start block. Usually, therefore, overcutting will result as shown in the Fig. 5.4.5 (e).

In such a case, it is possible to prevent overcutting by specifying a command with the exactly the same direction as the advance direction immediately before movement along the Z axis beforehand, after the tool is moved along the Z axis using the above rule.

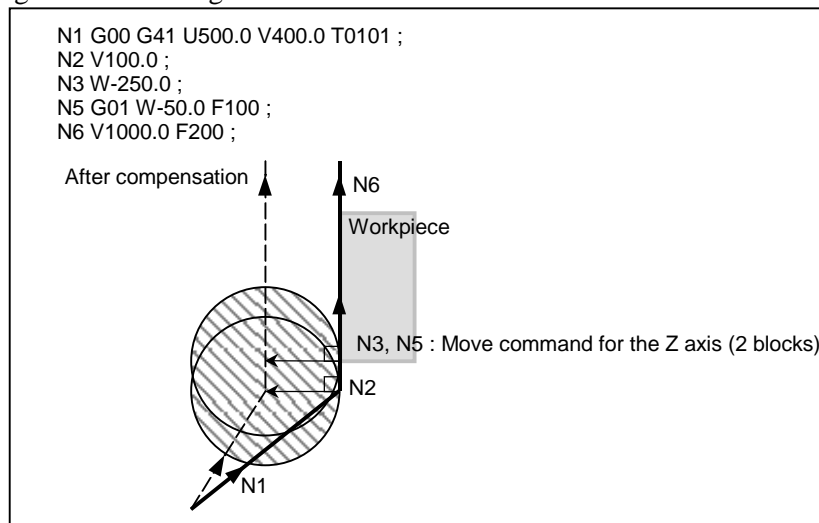

Fig. 5.4.5 (f)

As the block N2 has the move command in the same direction as that of the block N6, the correct compensation is performed.

Alternatively, it is possible to prevent overcutting in the same way by specifying an IJ type vector with the same direction as the advance direction in the start-up block, as in N1 G00 G41 U500.0 V500.0 I0 J1 T0101;, after the tool has moved along the Z axis.

### 5.4.6 Interference Check

Tool overcutting is called interference. The interference check function checks for tool overcutting in advance. However, all interference cannot be checked by this function. The interference check is performed even if overcutting does not occur.

## Explanation

### - Condition under which an interference check is possible

To perform an interference check, it is necessary to read at least three blocks with tool movement. If, therefore, three or more blocks with tool movement cannot be read in offset mode because blocks without tool movement, such as independent auxiliary function and dwell, are specified in succession, excessive or insufficient cutting may occur because an interference check fails. Assuming the number of blocks to read in offset mode, which is determined by parameter No. 19625, to be N and the number of commands in those N blocks without tool movement that have been read to be M, the condition under which an interference check is possible is

$$(N - 3) \geq M.$$

For example, if the maximum number of blocks to read in offset mode is 8, an interference check is possible even if up to five blocks without tool movement are specified. In this case, three adjacent blocks can be checked for interference, but any subsequent interference that may occur cannot be detected.

### - Interference check method

Two interference check methods are available, direction check and circular angle check. Bit 1 (CNC) of parameter No. 5008 and bit 3 (CNV) of parameter No. 5008 are used to specify whether to enable these methods.

Table 5.4.6 (a)

| CNV | CNC | Operation  |
|-----|-----|--|
| 0   | 0   | An interference check is enabled, and a direction check and a circular angle check can be performed. |
| 0   | 1   | An interference check is enabled, and only a circular angle check is performed.                      |
| 1   | –   | An interference check is disabled.   |

#### NOTE

There are no settings for performing a direction check only.

### - Interference reference <1> (direction check)

Assuming the number of blocks to read during tool nose radius compensation to be N, a check is first performed on the compensation vector group calculated in (block 1 - block 2) to be output this time and the compensation vector group calculated in (block N-1 - block N); if they intersect, they are judged to interfere. If no interference is found, a check is performed sequentially in the direction toward the compensation vector group to be output this time, as follows:

(Block 1 - block 2) and (block N-2 - block N-1)

(Block 1 - block 2) and (block N-3 - block N-2)

:

:

(Block 1 - block 2) and (block 2 - block 3)

Even if multiple number of compensation vector groups are generated, a check is performed on all pairs.

The judgment method is as follows: For a check on the compensation vector group in (block 1 - block 2) and those in (block N-1 - block N), the direction vector from the specified (end point of block 1) to the (end point of block N-1) is compared with the direction vector from the (point resulting from adding the compensation vector to be checked to the end of block 1) to the (point resulting from adding the compensation vector to be checked to the end of block N-1), and if the direction is 90° or greater or 270° or less, they are judged to intersect and interfere. This is called a direction check.



Example of interference standard <1>

(If the block 1 end-point vector intersects with the block 7 end-point vector)

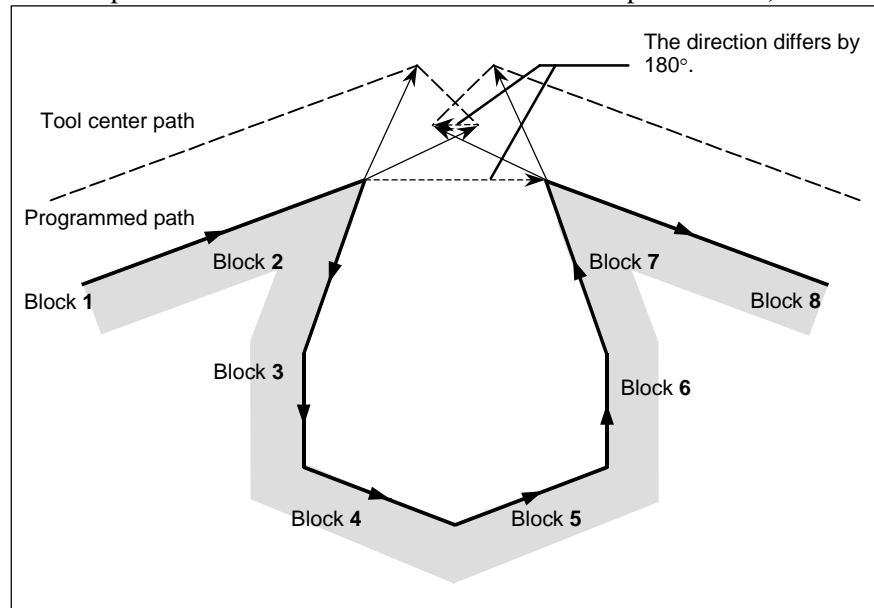

Fig. 5.4.6 (a)

Example of interference standard <1>

(If the block 1 end-point vector intersects with the block 2 end-point vector)

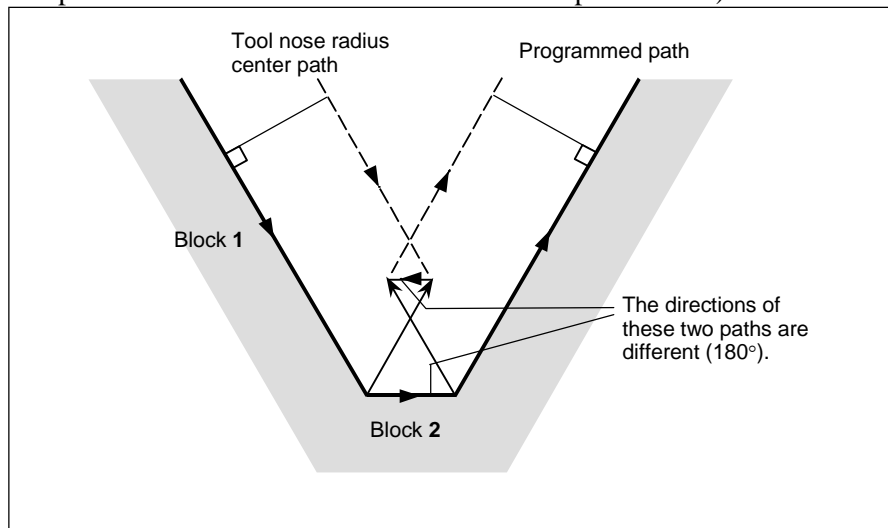

Fig. 5.4.6 (b)

### - Interference reference <2> (circular angle check)

In a check on three adjacent blocks, that is, a check on the compensation vector group calculated on (block 1 - block 2) and the compensation vector group calculated on (block 2 - block 3), if block 2 is circular, a check is performed on the circular angle between the start and end points of the programmed path and the circular angle of the start and end point of the post-compensation path, in addition to direction check <1>. If the difference is  $180^\circ$  or greater, the blocks are judged to interfere. This is called a circular angle check.

Example of <2> (if block 2 is circular and the start point of the post-compensation arc coincide with the end point)

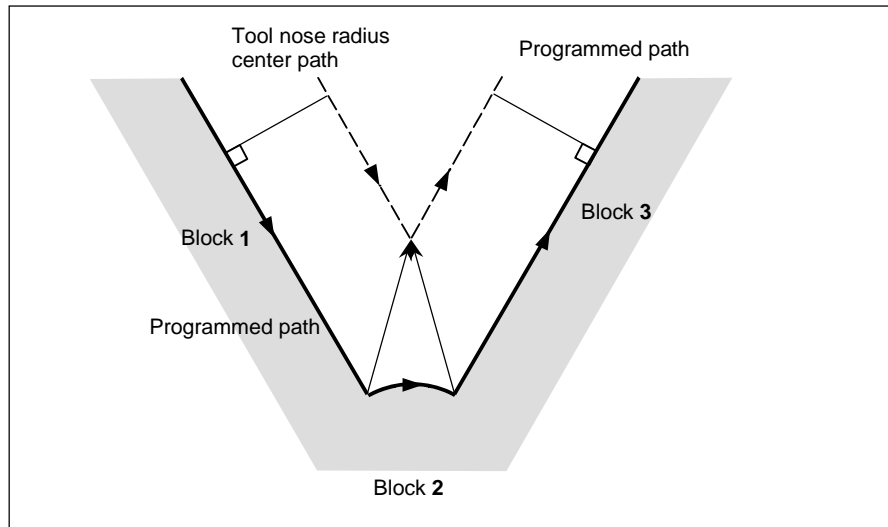

Fig. 5.4.6 (c)

- **When interference is assumed although actual interference does not occur**

<1> Depression which is smaller than the cutter or tool nose radius compensation value

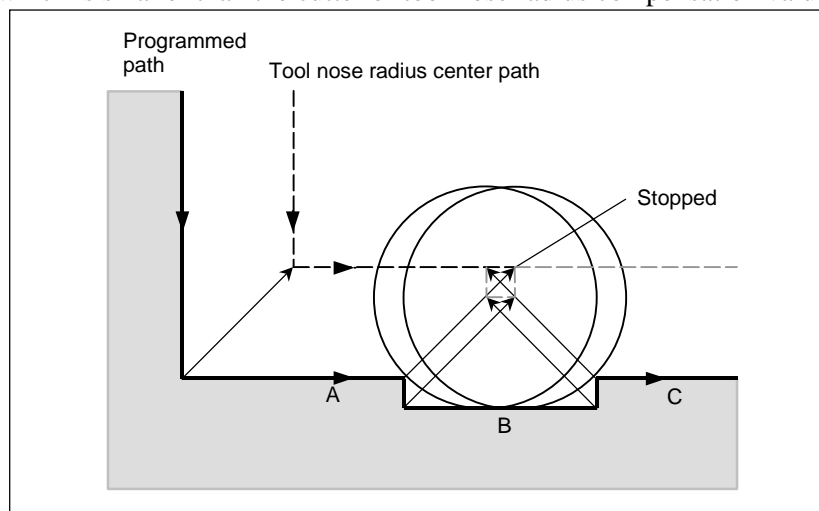

Fig. 5.4.6 (d)

There is no actual interference, but since the direction programmed in block B is opposite to that of the path after the tool nose radius compensation, the tool stops and an alarm is displayed.

<2> Groove which is smaller than the cutter or tool nose radius compensation value

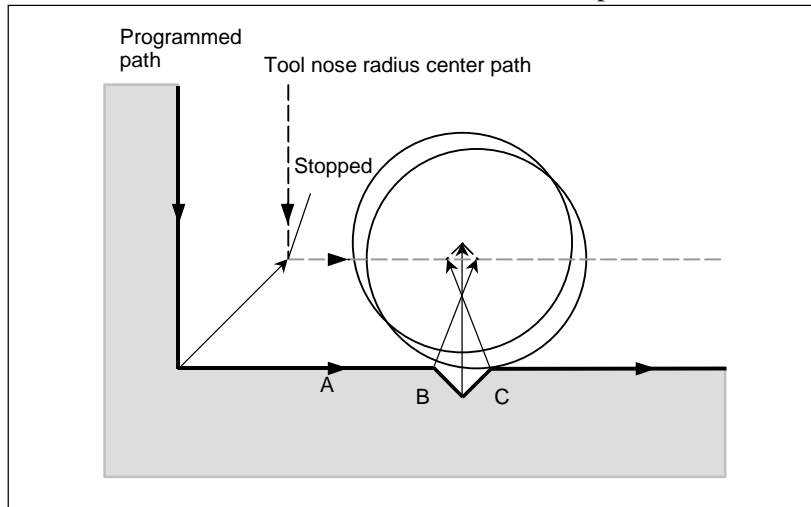

Fig. 5.4.6 (e)

Like <1>, an alarm is displayed because of the interference as the direction is reverse in block B.

### 5.4.6.1 Operation to be performed if an interference is judged to occur

#### Explanation

The operation to be performed if an interference check judges that an interference (due to overcutting) occurs can be either of the following two, depending on the setting of bit 5 (CAV) of parameter No. 19607.

Table 5.4.6.1 (a)

| CAV | Function                              | Operation   |
|-----|---------------------------------------|---|
| 0   | Interference check alarm function     | An alarm stop occurs before the execution of the block in which overcutting (interference) occurs.    |
| 1   | Interference check avoidance function | The tool path is changed so that overcutting (interference) does not occur, and processing continues. |

### 5.4.6.2 Interference check alarm function

#### Explanation

- **Interference other than those between adjacent three blocks**

If the end-point vector of block 1 and the end-point vector of block 7 are judged to interfere as shown in the Fig. 5.4.6.2 (a), an alarm will occur before the execution of block 1 so that the tool stops. In this case, the vectors will not be erased.

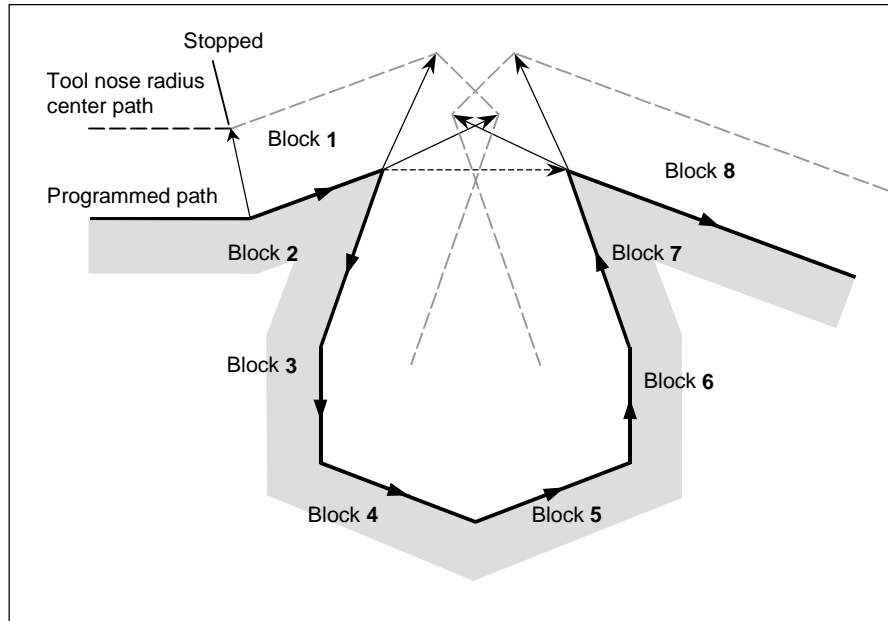

Fig. 5.4.6.2 (a)

#### - Interference between adjacent three blocks

If an interference is judged to occur between adjacent three blocks, the interfering vector, as well as any vectors existing inside of it, is erased, and a path is created to connect the remaining vectors. In the example shown in the Fig. 5.4.6.2 (b),  $V_2$  and  $V_5$  interfere, so that  $V_2$  and  $V_5$  are erased, so are  $V_3$  and  $V_4$ , which are inside of them, and  $V_1$  is connected to  $V_6$ . The operation during this time is linear interpolation.

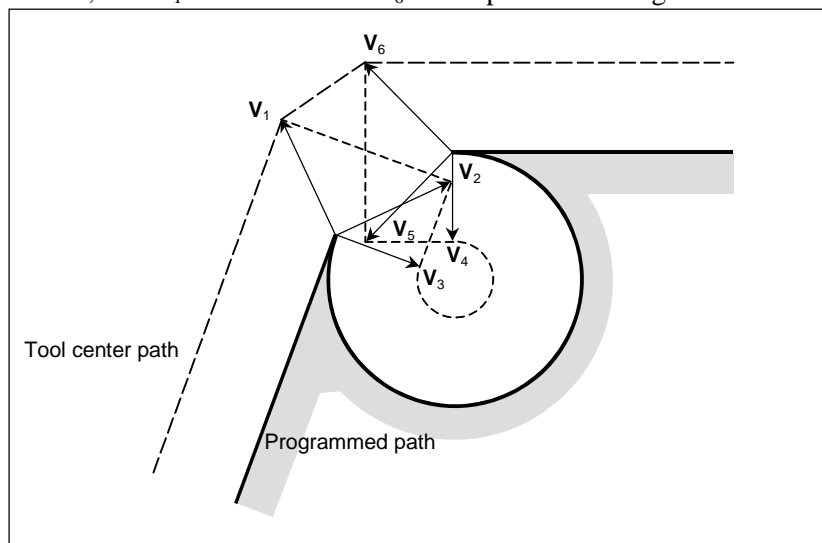

Fig. 5.4.6.2 (b)

If, after vector erasure, the last single vector still interferes, or if there is only one vector at the beginning and it interferes, an alarm will occur immediately after the start of the previous block (end point for a single block) and the tool stops. In the example shown in the Fig. 5.4.6.2 (c),  $V_2$  and  $V_3$  interfere, but, even after erasure, an alarm will occur because the final vectors  $V_1$  and  $V_4$  interfere.

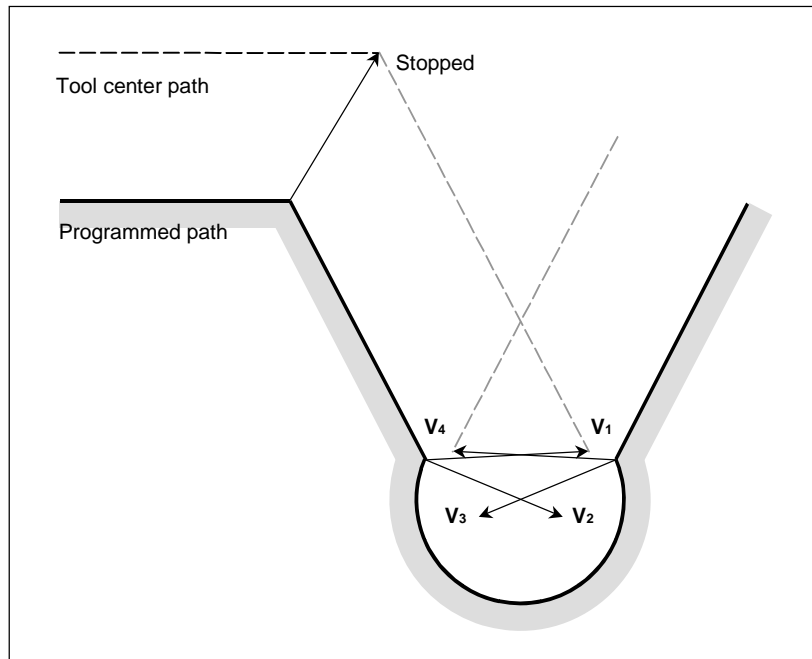

Fig. 5.4.6.2 (c)

### 5.4.6.3 Interference check avoidance function

#### Overview

If a command is specified which satisfies the condition under which the interference check alarm function generates an interference alarm, this function suppresses the generation of the interference alarm, but causes a new compensation vector to be calculated as a path for avoiding interference, thereby continuing machining. For the path for avoiding interference, insufficient cutting occurs in comparison with the programmed path. In addition, depending on the specified figure, no path for avoiding interference can be determined or the path for avoiding interference may be judged dangerous. In such a case, an alarm stop will occur. For this reason, it is not always possible to avoid interference for all commands.

#### Explanation

##### - Interference avoidance method

Let us consider a case in which an interference occurs between the compensation vector between (block 1 - block 2) and the compensation vector between (block N-1 - block N). The direction vector from the end point of block 1 to the end point of block N-1 is called a gap vector. At this time, a post-compensation intersection vector between (block 1 - gap vector) and a post-compensation intersection vector between (gap vector - block N) is determined, and a path connecting them is created.

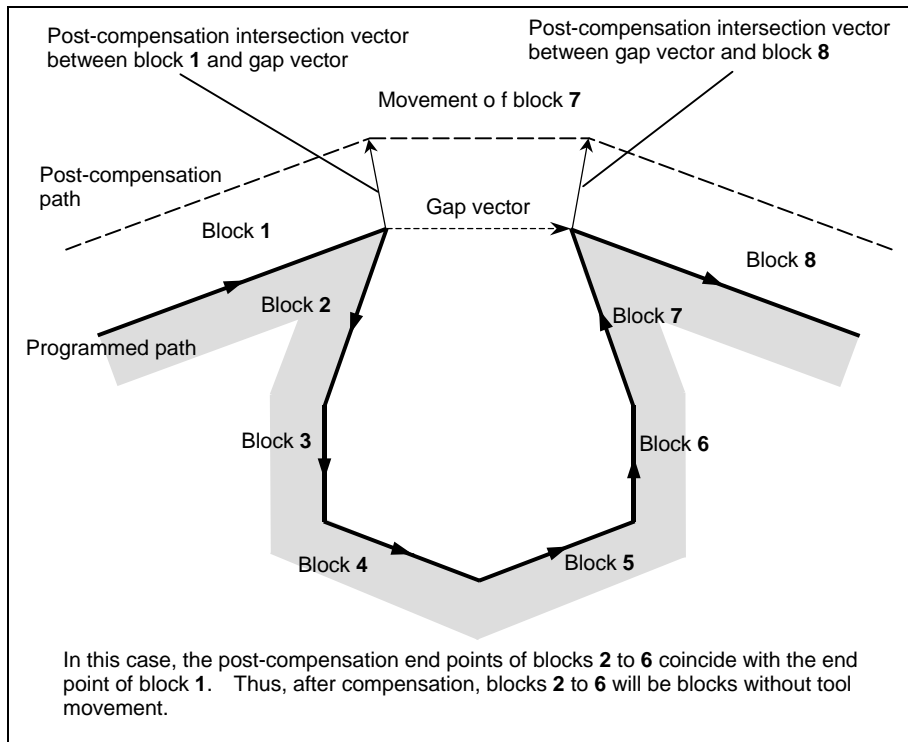

Fig. 5.4.6.3 (a)

If the post-compensation intersection vector of (block 1 - gap vector) and the post-compensation intersection vector of (gap vector - block N) further intersect, vector erasure is first performed in the same way as in "Interference between adjacent three blocks". If the last vectors that remains still intersects, the post-compensation intersection vector of (block 1 - block N) is re-calculated.

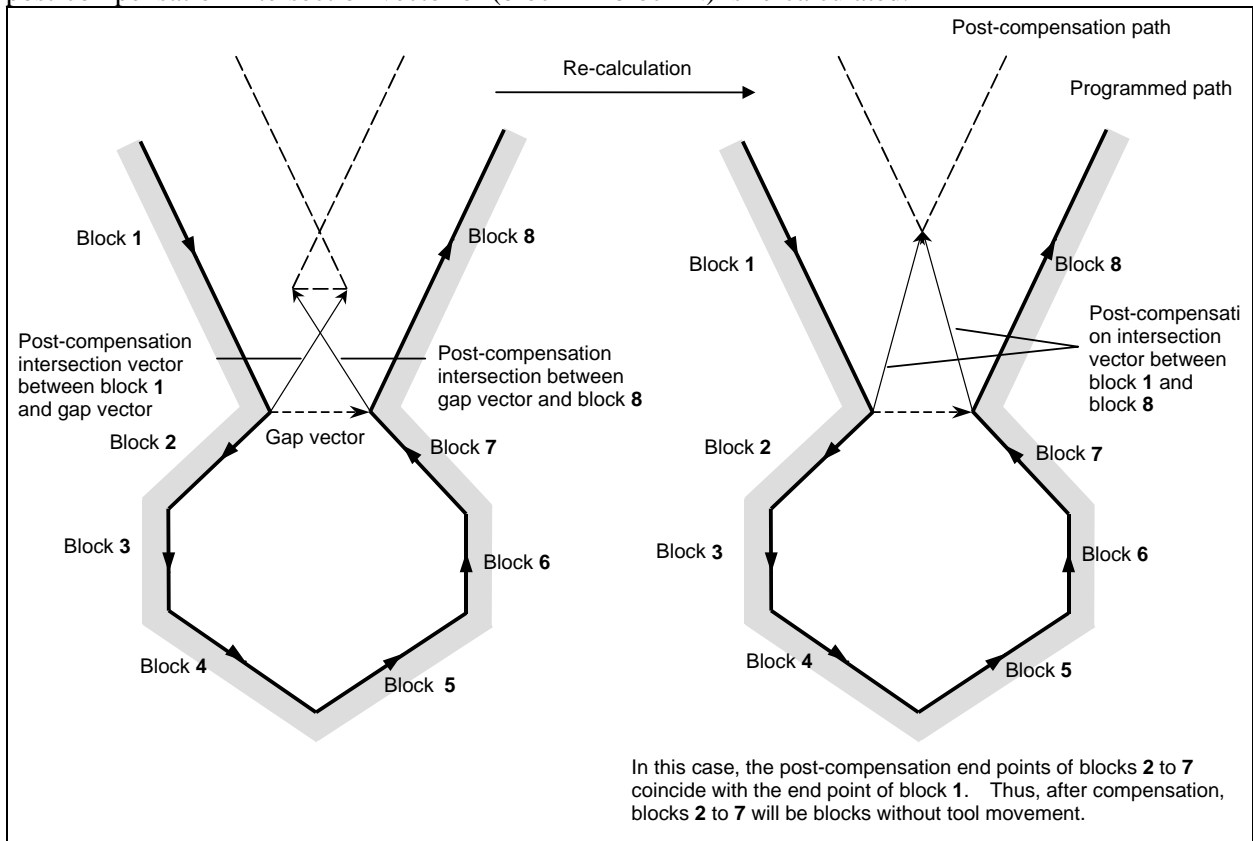

Fig. 5.4.6.3 (b)

If the cutter or tool nose radius compensation value is greater than the radius of the specified arc as shown in the Fig. 5.4.6.3 (c), and a command is specified which results in compensation with respect to the inside of the arc, interference is avoided by performing intersection calculation with an arc command being assumed a linear one. In this case, avoided vectors are connected with linear interpolation.

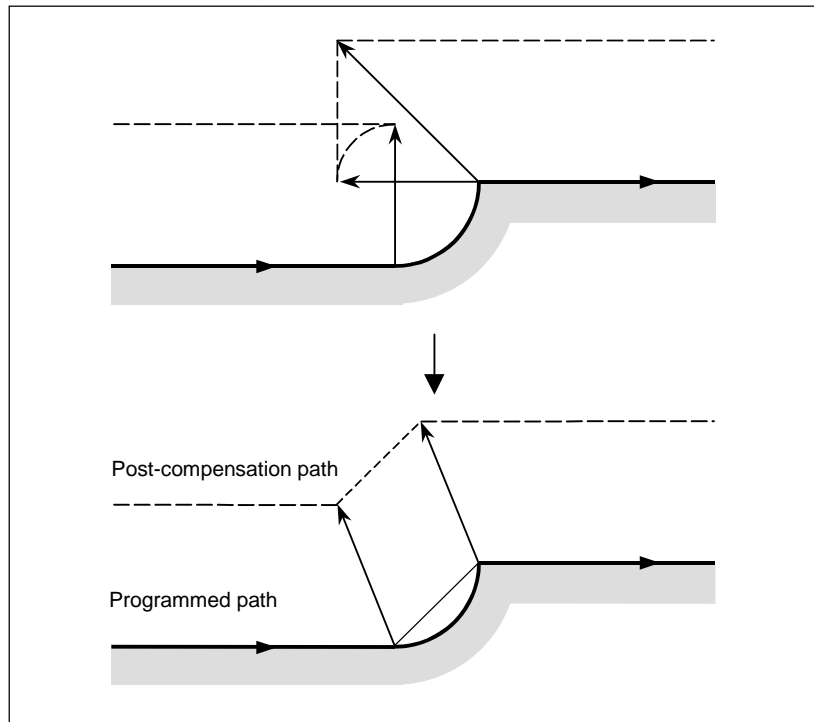

Fig. 5.4.6.3 (c)

#### - If no interference avoidance vector exists

If the parallel pocket shown in the Fig. 5.4.6.3 (d) is to be machined, the end-point vector of block 1 and the end-point vector of block 2 are judged to interfere, and an attempt is made to calculate, as an interference avoidance vector, the intersection vector of the post-compensation path of block 1 and the post-compensation path of block 3. In this case, because blocks 1 and 3 are parallel to each other, no intersection exists. In this case, an alarm will occur immediately before block 1 and the tool will stop.

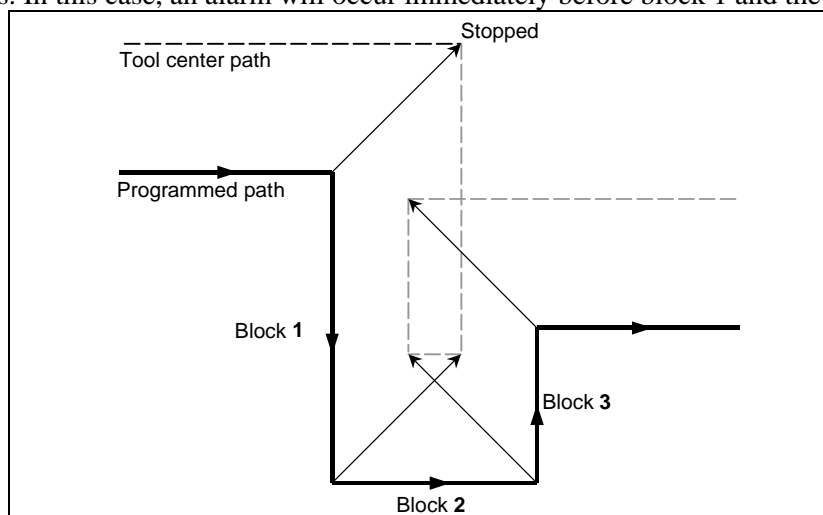

Fig. 5.4.6.3 (d)

If the circular pocket shown in the Fig. 5.4.6.3 (e) is to be machined, the end-point vector of block 1 and the end-point vector of block 2 are judged to interfere, and an attempt is made to calculate, as an interference avoidance vector, the intersection vector of the post-compensation path of block 1 and the post-compensation path of block 3.

In this case, because blocks 1 and 3 are circular, no post-compensation intersection exists. In this case, an alarm will occur immediately before block 1 and the tool will stop, as in the previous example.

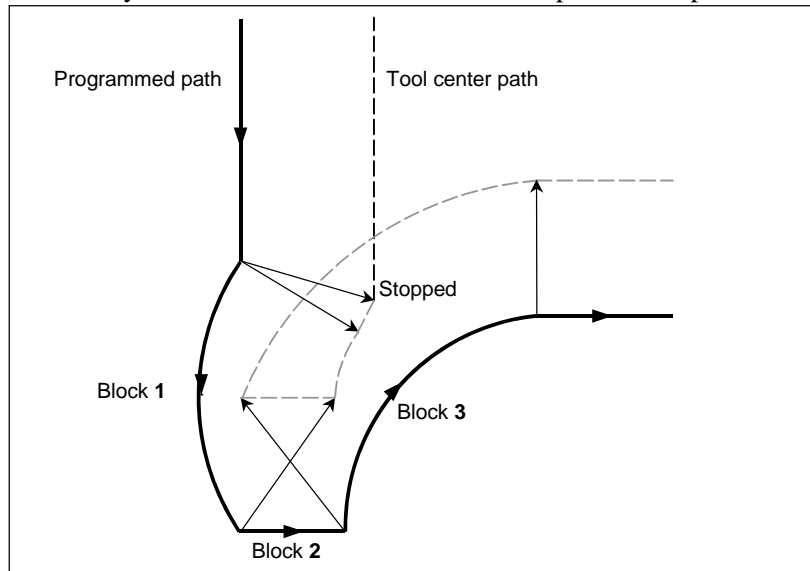

Fig. 5.4.6.3 (e)

#### - If it is judged dangerous to avoid interference

If the acute-angle pocket shown in the Fig. 5.4.6.3 (f) is to be machined, the end-point vector of block 1 and the end-point vector of block 2 are judged to interfere, and an attempt is made to calculate, as an interference avoidance vector, the intersection vector of the post-compensation path of block 1 and the post-compensation path of block 3. In this case, the movement direction of the post-avoidance path extremely differs from the previously specified direction. If the post-avoidance path extremely differs from that of the original command ( $90^\circ$  or greater or  $270^\circ$  or less), interference avoidance operation is judged dangerous; an alarm will occur immediately before block 1 and the tool will stop.

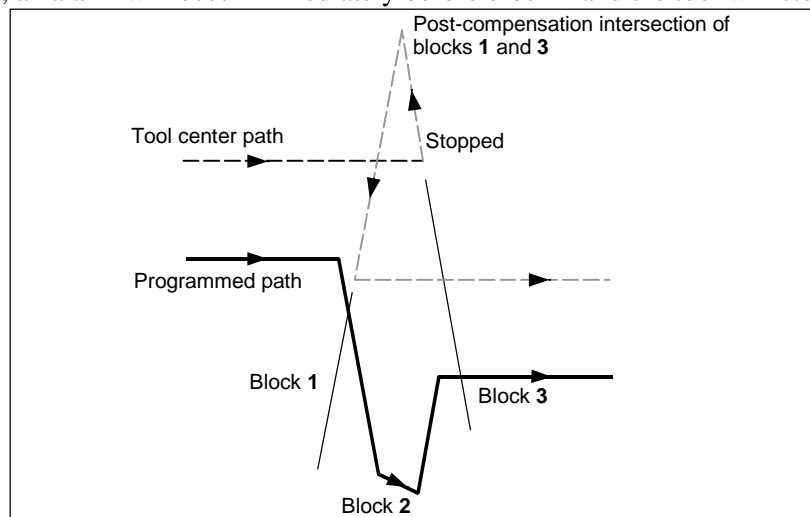

Fig. 5.4.6.3 (f)



If a pocket in which the bottom is wider than the top, such as that shown in the Fig. 5.4.6.3 (g), is to be machined, the end-point vector of block 1 and the end-point vector of block 2 are judged to interfere, and an attempt is made to calculate, as an interference avoidance vector, the intersection vector of the post-compensation path of block 1 and the post-compensation path of block 3. In this case, the relation between blocks 1 and 3 is judged an outer one, the post-avoidance path results in overcutting as compared with the original command. In such a case, interference avoidance operation is judge dangerous; an alarm will occur immediately before block 1 and the tool will stop.

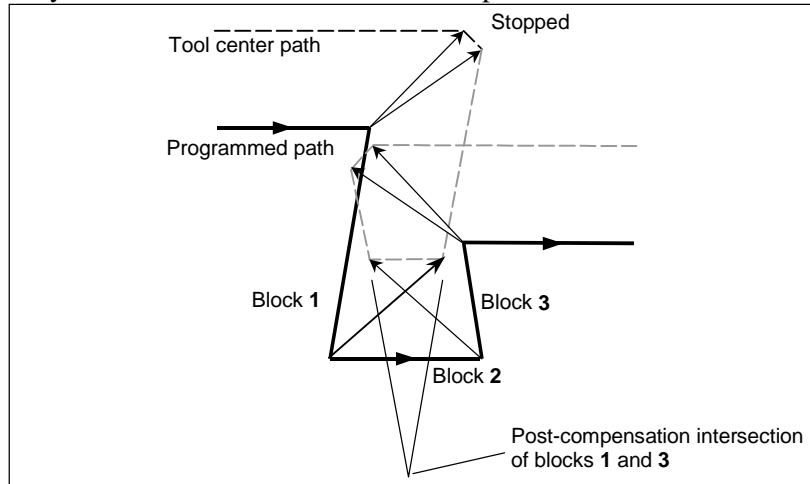

Fig. 5.4.6.3 (g)

**- If further interference with an interference avoidance vector occurs**

If the pocket shown in the Fig. 5.4.6.3 (h) is to be machined, if the number of blocks to read is 3, the end-point vector of block 1 and the end-point vector of block 2 are judged to interfere, and an attempt is made to calculate, as an interference avoidance vector, the intersection vector of the post-compensation path of block 1 and the post-compensation path of block 3. In this case, however, the end-point vector of block 3 that is to be calculated next further interferes with the previous interference avoidance vector. If a further interference occurs to the interference avoidance vector once created and output, the movement in the block will not be performed; an alarm will occur immediately before the block and the tool will stop.

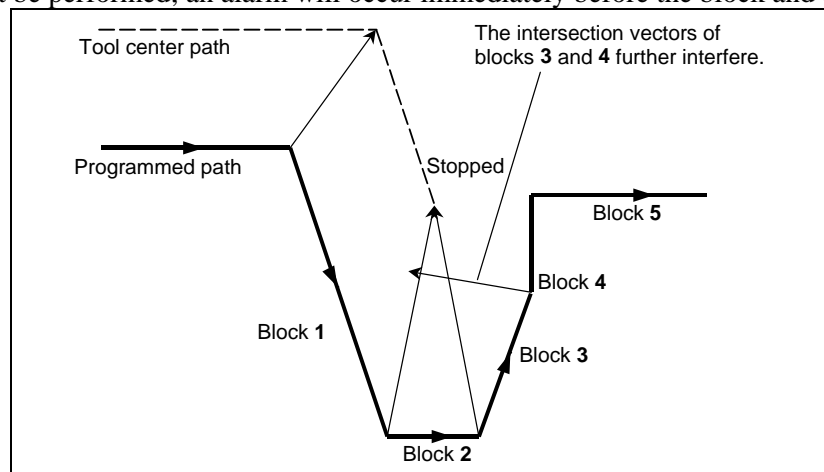

Fig. 5.4.6.3 (h)

**NOTE**

- 1 For "If it is judged dangerous to avoid interference" and "If further interference with an interference avoidance vector occurs", by setting bit 6 (NAA) of parameter No. 19607 appropriately, it is possible to suppress an alarm to continue machining. For "If no interference avoidance vector exists", however, it is not possible to avoid an alarm regardless of the setting of this parameter.
- 2 If a single block stop occurs during interference avoidance operation, and an operation is performed which differs from the original movement, such as manual intervention, MDI intervention, cutter or tool nose radius compensation value change, intersection calculation is performed with a new path. If such an operation is performed, therefore, an interference may occur again although interference avoidance has been performed once.

## 5.4.7 Cutter or Tool Nose Radius Compensation for Input from MDI

### Explanation

#### - MDI operation

During MDI operation, that is, if a program command is specified in MDI mode in the reset state to make a cycle start, intersection calculation is performed for compensation in the same way as in memory operation/DNC operation. Compensation is performed in the same way if a subprogram is called from program memory due to MDI operation.

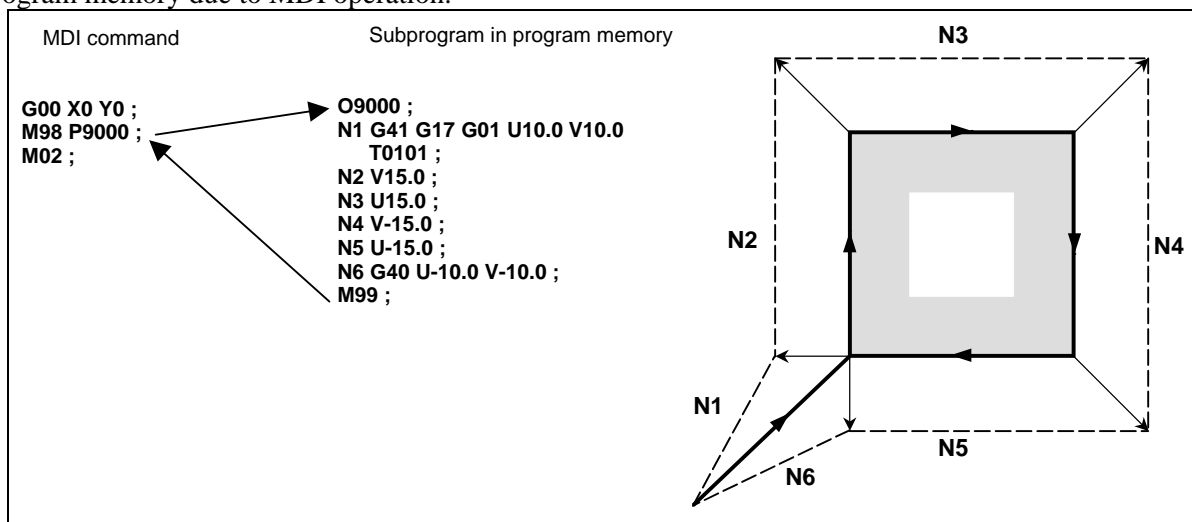

Fig. 5.4.7 (a)

#### - MDI intervention

If MDI intervention is performed, that is, if a single block stop is performed to enter the automatic operation stop state in the middle of memory operation, DNC operation, and the like, and a program command is specified in MDI mode to make a cycle start, cutter compensation does not perform intersection calculation, retaining the last compensation vector before the intervention.

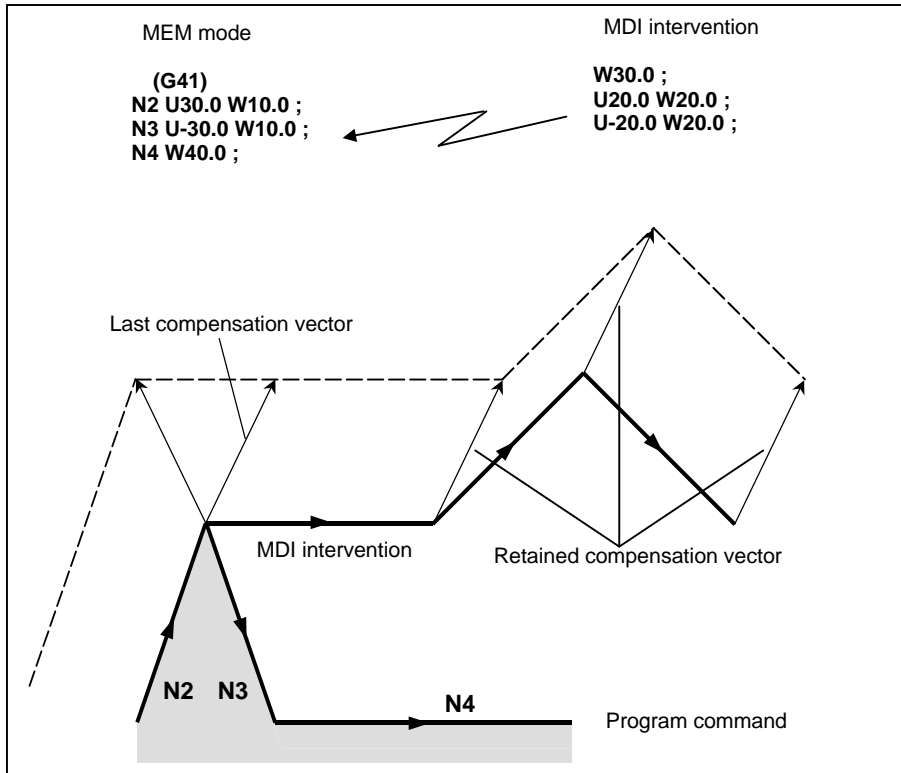

Fig. 5.4.7 (b)

## 5.5 VECTOR RETENTION (G38)

In cutter or tool nose radius compensation, by specifying G38 in offset mode, it is possible to retain the compensation vector at the end position of the previous block, without performing intersection calculation.

### Format

(In offset mode)

**G38 IP\_ ;**

IP :Value specified for axial movement

### Explanation

#### - Vector retention

By specifying the above command, a vector is created at the end point of the block immediately preceding the G38 block, vertical to that block. In the G38 block, the vertical vector output in the previous block is retained. G38 is a one-shot G code. With the next move command without a G38 command, the compensation vector is re-created.

### Limitation

#### - Mode

Specify G38 in either G00 or G01 mode. If it is specified in G02 or G03 (circular interpolation) mode, a radial error may occur at the start and end points.

#### - Start-up/cancel

In start-up/cancel, the operation is as described in Subsections 5.4.2 and 5.4.4. Thus, G38 cannot be specified in the following blocks:

- 1) Start-up command (G41 or G42) block
- 2) Cancel command (G40) block
- 3) Block immediately preceding the cancel command (G40) block

### Example

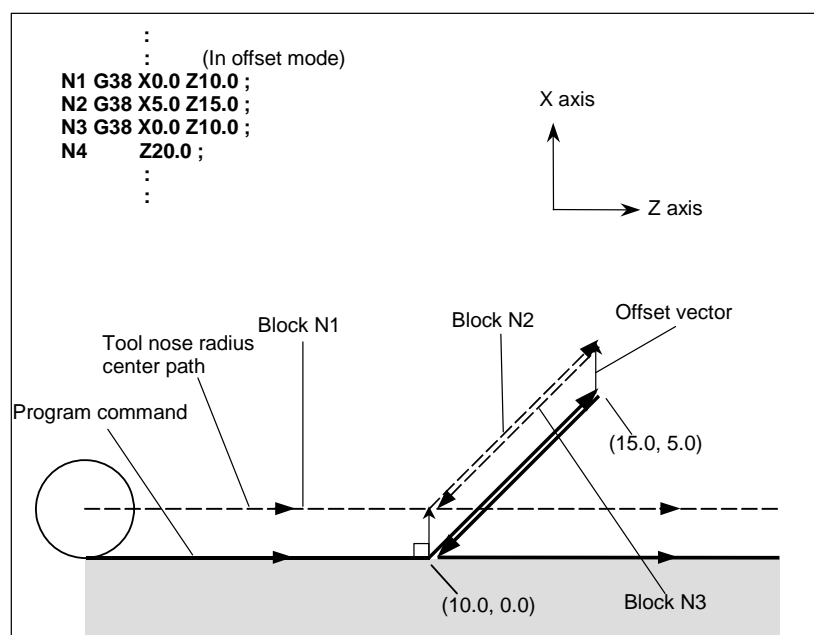

Fig. 5.5 (a)

## 5.6 CORNER CIRCULAR INTERPOLATION (G39)

By specifying G39 in offset mode during cutter or tool nose radius compensation, corner circular interpolation can be performed. The radius of the corner circular interpolation equals the compensation value.

### Format

|  |
|--|
| In offset mode<br><b>G39 ;</b><br>or<br><b>G39</b> { $\begin{matrix} \text{I\_J\_} \\ \text{I\_K\_} \\ \text{J\_K\_} \end{matrix}$ } ; |
|--|

### Explanation

#### - Corner circular interpolation

When the command indicated above is specified, corner circular interpolation in which the radius equals compensation value can be performed. G41 or G42 preceding the command determines whether the arc is clockwise or counterclockwise. G39 is a one-shot G code.

#### - G39 without I, J, or K

When G39; is programmed, the arc at the corner is formed so that the vector at the end point of the arc is perpendicular to the start point of the next block.

#### - G39 with I, J, and K

When G39 is specified with I, J, and K, the arc at the corner is formed so that the vector at the end point of the arc is perpendicular to the vector defined by the I, J, and K values.

### Limitation

#### - Move command

In a block containing G39, no move command can be specified. Otherwise, an alarm will occur.

#### - Inner corner

In an inner corner block, G39 cannot be specified. Otherwise, overcutting will occur.

#### - Corner arc velocity

If a corner arc is specified with G39 in G00 mode, the corner arc block velocity will be that of the F command previously specified.

**Example**

**- G39 without I, J, or K**

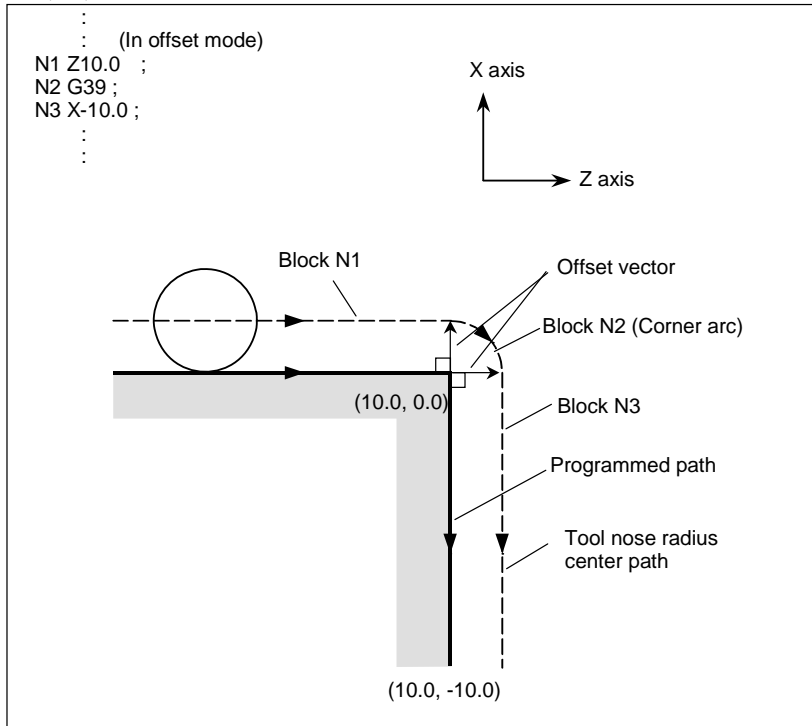

**Fig. 5.6 (a)**

**- G39 with I, J, and K**

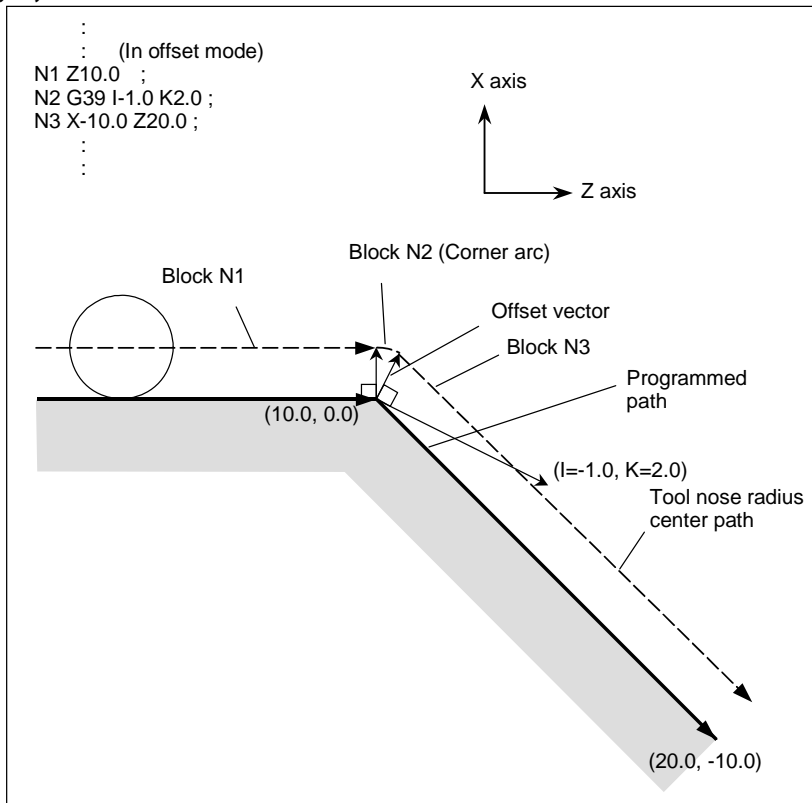

**Fig. 5.6 (b)**

## 5.7 EXTENDED TOOL SELECTION

### Overview

In lathe system machines, tools are changed mainly with the following two methods:

- (1) With a turret holding multiple tools, tools are changed by turning the turret (T command).
- (2) With an automatic tool changer (ATC), tools are changed by using both cartridge indexing (T command) and tool change (such as M06) commands.

To support the tool change method explained in (2) above, the following tool selection specifications apply to this function:

- <1> Tool compensation by a T command is disabled. This means that the T command performs auxiliary functions only.
- <2> Tool compensation is enabled by using a G code instead of the T command. In this case, the following types of tool compensation are enabled:
- Tool offset (compensation equivalent to that of a T command in the case of turret rotation type)

### Format

|                 |                             |
|-----------------|-----------------------------|
| <b>M06 T_ ;</b> | Change tool                 |
| :               |                             |
| <b>Gxx D_ ;</b> | Tool compensation start     |
| :               |                             |
| :               |                             |
| <b>G49 ;</b>    | Tool compensation cancel    |
|                 |                             |
| Gxx             | : Type of tool compensation |
| G43.7           | : Tool offset               |
| D_              | : Tool compensation number  |

### Explanation

#### - Selecting a tool change method

Bit 3 (TCT) of parameter No. 5040 selects a tool change method.

This changes the way for specifying tool compensation.

This parameter setting has influence on the following range (Table 5.7 (a)):

Table 5.7 (a)

|   | Bit 3 (TCT) of parameter No. 5040 =<br>0 (Turret type) | Bit 3 (TCT) of parameter No. 5040 =<br>1 (ATC type) |
|---|--|---|
| Operation of T command                            | Auxiliary function (tool change) and tool offset       | Auxiliary function (tool indexing) only             |
| Tool compensation                                 | Specified with T code                                  | Specified with G43.7 D_                             |
| Compensation No. of tool compensation             | Specified with T code                                  | Specified with D code                               |
| Compensation No. of tool nose radius compensation | Specified with T code                                  | Specified with D code                               |
| Command such as G43                               | Disabled (alarm)                                       | Enabled   |
| Compensation No. of G43, etc.                     | -  | Specified with D code                               |

**- T command operation**

- (1) When bit 3 (TCT) of parameter No.5040 is 0  
The T command performs an auxiliary function and tool offset.  
The code signal issued to the machine is the T command value except the last 1 to 3 digits.  
For example, suppose that the following command is issued when 2 is set in parameter No. 5028 (the number of digits comprising the offset number in the T code command):  
T0313 ;  
The T code signal sent to the machine indicates 03.  
The tool compensation number, indicated by the lowest 2 digits, is 13.
- (2) When bit 3 (TCT) of parameter No. 5040 is 1  
The T command performs an auxiliary function only.  
In this case, the code signal issued to the machine is the T command value.  
For example, suppose that the following is specified:  
T0313 ;  
The T code signal issued to the machine is 0313. The T code signal is not affected by the setting of parameter No. 5028 (the number of digits comprising the offset number in the T code command).  
The tool compensation number is not affected by this command.

**- Tool offset**

- (1) When bit 3 (TCT) of parameter No.5040 is 0  
The T command performs tool offset.
- (2) When bit 3 (TCT) of parameter No.5040 is 1  
The T command does not perform tool offset.  
To provide tool offset, specify G43.7 D\_\_.  
Tool offset is performed in the same way as with the T command when bit 3 of parameter No. 5040 is 0.

**- Compensation number of tool offset**

- (1) When bit 3 (TCT) of parameter No.5040 is 0  
The lowest 1 to 3 digits of the T command are used. The number of digits is set in parameter No. 5028.  
When the tool geometry/wear offset is enabled (bit 6 (NGW) of parameter No.8136 is 0), tool geometry offset and wear offset may also be assigned different compensation values by setting bit 1 (LGN) of parameter No. 5002.  
For details, refer to the description of the tool selection function in the Operator's Manual (Common to Lath System/Machining Center System).
- (2) When bit 3 (TCT) of parameter No.5040 is 1  
Except that a compensation number is specified with a D command, the same operation as (1) above is performed.

**- Compensation number of tool nose radius compensation**

Same as for tool offset described above.

**- Specification of G43, etc.**

- (1) When bit 3 (TCT) of parameter No.5040 is 0  
G codes of group 23 such as G43 cannot be specified.  
Specifying such a G code results in an alarm PS0366.



- (2) When bit 3 (TCT) of parameter No.5040 is 1  
 G codes of group 23 such as G43 can be specified. The following G codes can be specified:  
 G43.7: Tool offset  
 Specify a compensation number with D\_. The D code is specified in the same way as for tool offset and tool nose radius compensation.

The reverse meanings can be set for G43/G44 and G43.7 by setting bit 4 (TLG) of parameter No. 5040.

#### - Tool compensation memory

As the compensation amount used by the functions listed below, only the value set in Z on the tool compensation memory screen is used, Values such as values set for the X, R, and Y-axis offsets are ignored.

As the compensation amount used in the following function, the values set for the X, Z, and Y-axis offsets on the tool compensation memory screen are used:

G43.7: Tool offset

### Limitation

#### - Multiple repetitive canned cycle

When a multiple repetitive canned cycle is executed with bit 3 (TCT) of parameter No. 5040 set to 1, note the following:

#### CAUTION

- 1 When a G71 to G76 command is specified in the Series 10/11 program format, a value such as the depth of cut is specified with a D code. In this case, a D command specified after G71 to G76 is assumed to be the depth of cut. For example, suppose that the command shown below is specified. In this case, the D command <1> is assumed to be the tool compensation number, and the D command <2> is assumed to be the depth of cut.

Example:

```
D10 G71 P_Q_ U_ W_ D7000 F_ S_;
<1>                <2>
```

- 2 In the operation of G71 to G73, a G code such as G43 and a D command specified in the finish figure blocks (the portion enclosed by the sequence numbers specified with P\_ and Q\_) are ignored, and the compensation amount set when the G71 to G73 block is specified becomes valid.

#### - Modifying the setting of bit 3 (TCT) of parameter No. 5040

#### WARNING

Before modifying the setting of this parameter, ensure that the offset is canceled. If the setting is modified with the offset applied, offset operation may be performed incorrectly after that, or alarm PS0368 may be issued.

## 5.8 AUTOMATIC TOOL OFFSET (G36, G37)

When a tool is moved to the measurement position by execution of a command given to the CNC, the CNC automatically measures the difference between the current coordinate value and the coordinate value of the command measurement position and uses it as the offset value for the tool. When the tool has been already offset, it is moved to the measurement position with that offset value. If the CNC judges that further offset is needed after calculating the difference between the coordinate values of the measurement position and the commanded coordinate values, the current offset value is further offset. Refer to the instruction manuals of the machine tool builder for details.

### NOTE

When bit 7 (IGA) of parameter No.6240 is 0, this function can be used.

### Format

|                             |   |
|-----------------------------|---|
| <b>Txx ;</b>                | Specifies an offset number for tool position compensation.  |
| <b>G36 X_ ; or G37 Z_ ;</b> | Automatic tool offset. Absolute programming.<br>G36 and G37 are valid only in the block in which it is specified. |

### Explanation

#### - Coordinate system

When moving the tool to a position for measurement, the coordinate system must be set in advance. (The workpiece coordinate system for programming is used in common.)

#### - Movement to measurement position

A movement to a measurement position is performed by specifying as follows in the MDI, or MEM mode :

G36 Xxa ; or G37 Zza ;

(In the case of setting bit 3 (G36) of parameter No.3405 to 1, G37.1 Xxa ; or G37.2 Zza ;)

In this case, the measurement position should be xa or za (absolute programming).

Execution of this command moves the tool at the rapid traverse rate toward the measurement position, lowers the feedrate halfway, then continues to move it until the approach end signal from the measuring instrument is issued.

When the tool tip reaches the measurement position, the measuring instrument outputs the measurement position reach signal to the CNC which stops the tool.

#### - Offset

The current tool offset value is further offset by the difference between the coordinate value ( $\alpha$  or  $\beta$ ) when the tool has reached the measurement position and the value of xa or za specified in G36Xxa or G37Zza.

Offset value x = Current offset value x + ( $\alpha$  - xa)

Offset value z = Current offset value z + ( $\beta$  - za)

xa : Programmed X-axis measurement point

za : Programmed Z-axis measurement point

These offset values can also be altered from the MDI keyboard.

#### - Feedrate toward the measurement position and alarm

The tool, when moving from the starting position toward the measurement position predicted by xa or za in G36 or G37, is feed at the rapid traverse rate across area A. Then the tool stops at point T (xa- $\gamma$  or za- $\gamma$ ) and moves at the measurement feedrate set by parameter No. 6241 across areas B, C, and D. If the

approach end signal turns on during movement across area B, alarm is generated. If the approach end signal does not turn on before point V, and tool stops at point V and alarm PS0080 is generated.

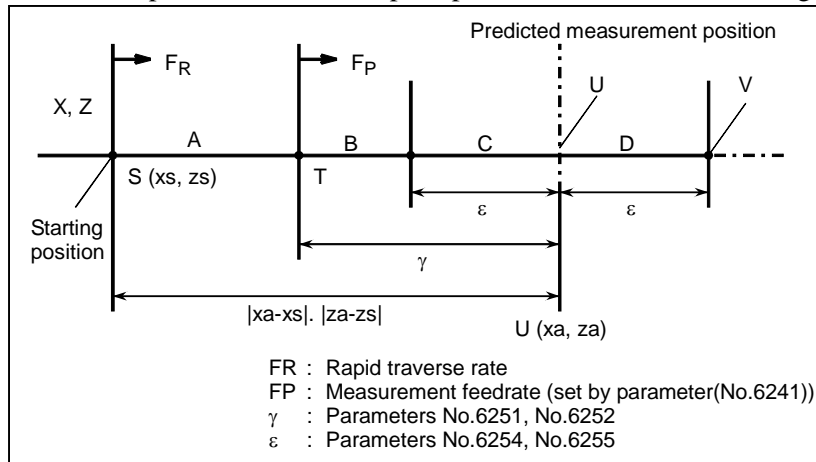

Fig. 5.8 (a) Feedrate and alarm

**- G code**

If bit 3 (G36) of parameter No. 3405 has been set to 1, G37.1 and G37.2 are used as the G codes for automatic tool compensation for the X- and Z-axes, respectively.

**Example**

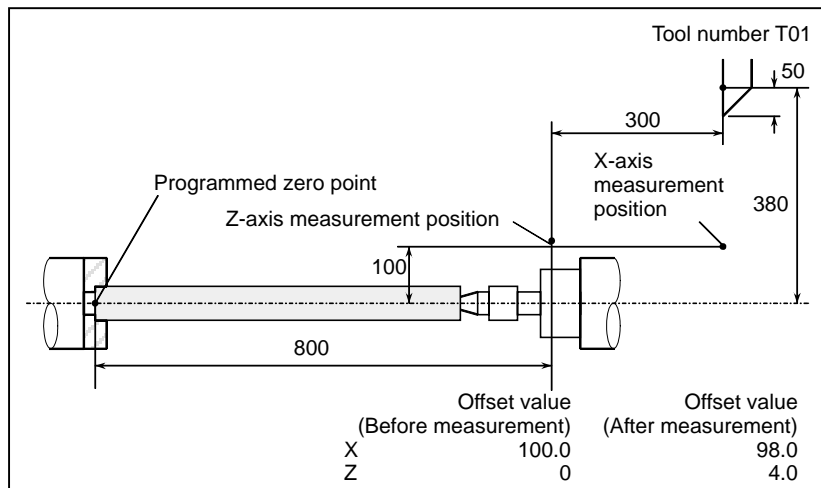
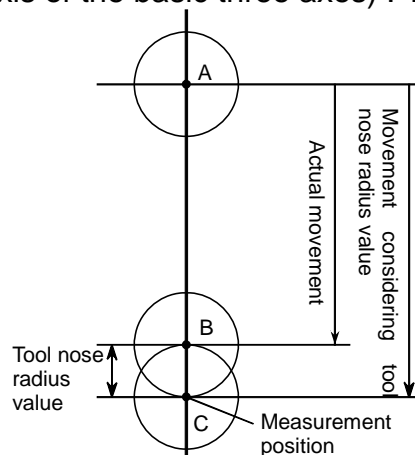

Fig. 5.8 (b)

```
G50 X760.0 Z1100.0 ; Programming of absolute zero point (Coordinate system setting)
S01 M03 T0101 ; Specifies tool T1, offset number 1, and spindle revolution
G36 X200.0 ; Moves to the X-axis measurement position
If the tool has reached the measurement position at X198.0 since the correct measurement position is 200.0mm, the offset value is altered by 198.0-200.0=-2.0mm.
G00 X204.0 ; Retracts a little along the X axis.
G37 Z800.0 ; Moves to the Z-axis measurement position.
If the tool has reached the measurement position at Z804.0 since the correct measurement position is 800.0mm, the offset value is altered by 804.0-800.0=4.0mm.
T0101 ; The new offset value becomes valid when the T code is specified again.
```

**⚠ WARNING**

- 1 Measurement speed( $F_p$ ),  $\gamma$ , and  $\varepsilon$  are set as parameters ( $F_p$  : No.6241,  $\gamma$  : No.6251,  $\varepsilon$  : No.6254) by machine tool builder.  $\varepsilon$  must be positive numbers so that  $\gamma > \varepsilon$ .
- 2 Cancel the tool nose radius compensation before G36, G37.
- 3 A delay or variation in detection of the measurement position arrival signal is 0 to 2 msec on the CNC side excluding the PMC side. Therefore, the measurement error is the sum of 2 msec and a delay or variation (including a delay or variation on the receiver side) in propagation of the measurement position arrival signal on the PMC side, multiplied by the feedrate set in parameter No. 6241.
- 4 A delay or variation in time after detection of the measurement position arrival signal until a feed stops is 0 to 8 msec. To calculate the amount of overrun, further consider a delay in acceleration/deceleration, servo delay, and delay on the PMC side.
- 5 When a manual movement is inserted into a movement at a measurement feedrate, return the tool to the position before the inserted manual movement for restart.
- 6 When tool nose radius compensation is enabled (bit 7 (NCR) of parameter No. 8136 is set to 0), the tool offset amount is determined considering the value of tool nose R. Make sure that tool nose radius value is set correctly.  
(Condition under which the tool-nose radius compensation is considered)  
For the X-axis (first axis of the basic three axes) : TIP=0/5/7  
For the Z-axis (third axis of the basic three axes) : TIP=0/6/8  
For the Y-axis (second axis of the basic three axes) : TIP=0



The tool actually moves from point A to point B, but the tool offset value is determined assuming that the tool moves to point C considering the tool nose radius value.

**NOTE**

- 1 When there is no T code command before G36 or G37, alarm PS0081, "G37 OFFSET NO. UNASSIGNED" is generated.
- 2 When a T code is specified in the same block as G36 or G37, alarm PS0082, "G37 SPECIFIED WITH T CODE" is generated.

# 6 MEMORY OPERATION USING Series 10/11 FORMAT

By setting the setting-related parameter (bit 1 of parameter No. 0001), a program created in the Series 10/11 program format can be registered in memory for memory operation. Registration to memory and memory operation are possible for the functions which use the same program format as that for the Series 10/11 as well as for the following functions which use a different program format:

- Subprogram calling
- Canned cycle
- Multiple repetitive canned cycle
- Canned cycle for drilling

This function is optional.

## NOTE

- 1 Registration to memory and memory operation are possible only for the functions available in Series *0i*.
- 2 Do not change the setting of this parameter (bit 1 (FCV) of parameter No. 0001) during memory operation. Change the setting of this parameter in the reset state.

Chapter 6, "MEMORY OPERATION USING Series 10/11 FORMAT", consists of the following sections:

|   |     |
|---|-----|
| 6.1 ADDRESSES AND SPECIFIED RANGE FOR SERIES 10/11 PROGRAM FORMAT ..... | 231 |
| 6.2 SUBPROGRAM CALLING.....   | 231 |
| 6.3 CANNED CYCLE.....   | 232 |
| 6.4 MULTIPLE REPETITIVE CANNED CYCLE.....                               | 249 |
| 6.5 CANNED CYCLE FOR DRILLING .....                                     | 283 |

## 6.1 ADDRESSES AND SPECIFIED RANGE FOR Series 10/11 PROGRAM FORMAT

Some addresses which cannot be used for the Series *0i* can be used in the Series 10/11 program format. The specifiable value range for the Series 10/11 program format is basically the same as that for the Series *0i*. The addresses with a different specifiable value range are described as follows. If a value out of the specified range is specified, an alarm is issued.

## 6.2 SUBPROGRAM CALLING

### Format

**M98 Pxxxx Lyyyy ;**

P : Subprogram number

L : Repetition count

---

**Explanation****- Address**

Address L cannot be used in Series *0i* program format but can be used in the Series 10/11 format. (When the custom macro is enabled (bit 6(NCV) of parameter No. 8135 is 0), address L can be used regardless of whether the format is Series 10/11 or not, however.)

**- Subprogram number**

The specifiable value range is the same as that for Series *0i* (1 to 9999).

If a value of more than five digits is specified, the last four digits are assumed as the subprogram number.

**- Repetition count**

The repetition count L can be specified in the range from 1 to 9999. If no repetition count is specified, 1 is assumed.

---

## 6.3 CANNED CYCLE

---

**Explanation**

There are three canned cycles: the outer diameter/internal diameter cutting canned cycle (G90), the threading canned cycle (G92), and the end face turning canned cycle (G94).

**NOTE**

- 1 Explanatory figures in this section use the ZX plane as the selected plane, diameter programming for the X-axis, and radius programming for the Z-axis. When radius programming is used for the X-axis, change U/2 to U and X/2 to X.
- 2 A canned cycle can be performed on any plane (including parallel axes for plane definition). When G code system A is used, however, U, V, and W cannot be set as a parallel axis.
- 3 The direction of the length means the direction of the first axis on the plane as follows:  
ZX plane: Z-axis direction  
YZ plane: Y-axis direction  
XY plane: X-axis direction
- 4 The direction of the end face means the direction of the second axis on the plane as follows:  
ZX plane: X-axis direction  
YZ plane: Z-axis direction  
XY plane: Y-axis direction

## 6.3.1 Outer Diameter/Internal Diameter Cutting Cycle (G90)

This cycle performs straight or taper cutting in the direction of the length.

### 6.3.1.1 Straight cutting cycle

#### Format

**G90X(U)\_Z(W)\_F\_;**

- X\_,Z\_ : Coordinates of the cutting end point (point A' in the Fig. 6.3.1.1 (a)) in the direction of the length
- U\_,W\_ : Travel distance to the cutting end point (point A' in the Fig. 6.3.1.1 (a)) in the direction of the length
- F\_ : Cutting feedrate

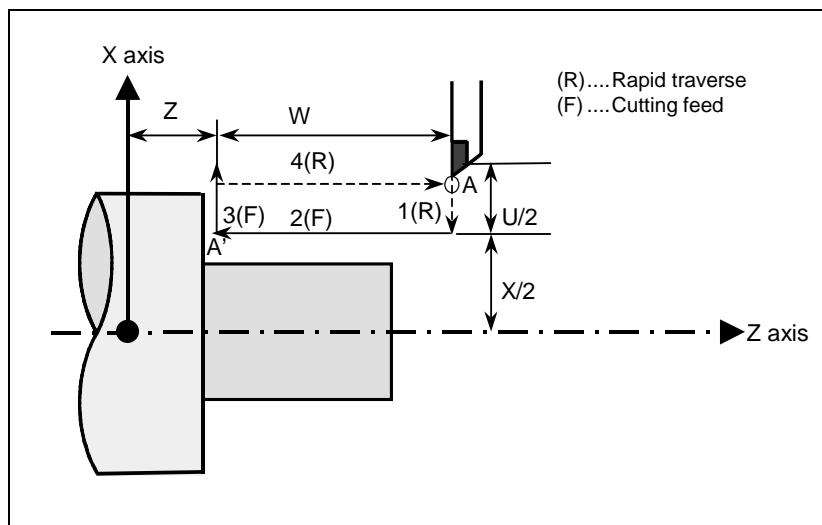

Fig. 6.3.1.1 (a) Straight cutting cycle

#### Explanation

##### - Operations

A straight cutting cycle performs four operations:

- (1) Operation 1 moves the tool from the start point (A) to the specified coordinate of the second axis on the plane (specified X-coordinate for the ZX plane) in rapid traverse.
- (2) Operation 2 moves the tool to the specified coordinate of the first axis on the plane (specified Z-coordinate for the ZX plane) in cutting feed. (The tool is moved to the cutting end point (A') in the direction of the length.)
- (3) Operation 3 moves the tool to the start coordinate of the second axis on the plane (start X-coordinate for the ZX plane) in cutting feed.
- (4) Operation 4 moves the tool to the start coordinate of the first axis on the plane (start Z-coordinate for the ZX plane) in rapid traverse. (The tool returns to the start point (A).)

#### NOTE

In single block mode, operations 1, 2, 3 and 4 are performed by pressing the cycle start button once.

##### - Canceling the mode

To cancel the canned cycle mode, specify a group 01 G code other than G90, G92, or G94.

### 6.3.1.2 Taper cutting cycle

#### Format

ZpXp-plane

**G90 X(U)\_ Z(W)\_ I\_ F\_ ;**

YpZp-plane

**G90 Y(V)\_ Z(W)\_ K\_ F\_ ;**

XpYp-plane

**G90 X(U)\_ Y(V)\_ J\_ F\_ ;**

X\_,Y\_,Z\_ : Coordinates of the cutting end point (point A' in the Fig. 6.3.1.2 (a)) in the direction of the length

U\_,V\_,W\_ : Travel distance to the cutting end point (point A' in the Fig. 6.3.1.2 (a)) in the direction of the length

I\_,J\_,K\_ : Taper amount (I in the figure below)

F\_ : Cutting feedrate

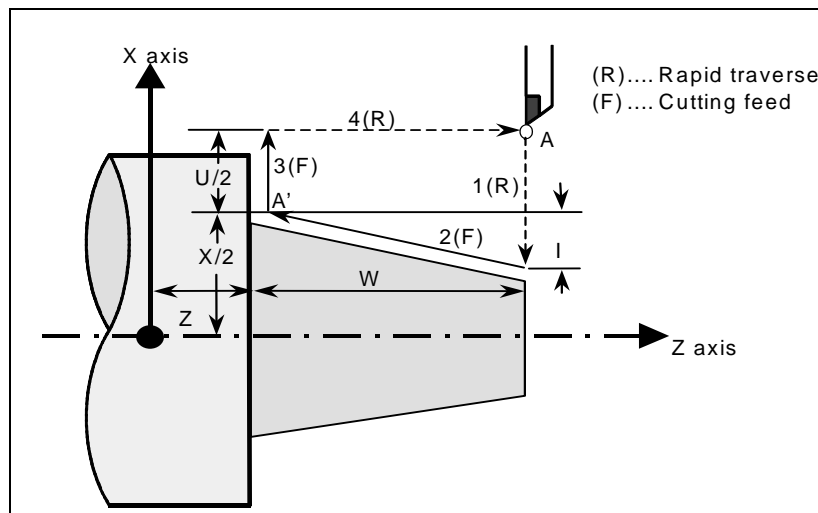

Fig. 6.3.1.2 (a) Taper cutting cycle

#### Explanation

Address I, J, or K for specifying a taper varies with the plane selected.

The figure of a taper is determined by the coordinates of the cutting end point (A') in the direction of the length and the sign of the taper amount (address I, J, or K). For the cycle in the figure above, a minus sign is added to the taper amount.

#### NOTE

The increment system of address I, J, or K for specifying a taper depends on the increment system for the reference axis. Specify a radius value at I, J, or K.

#### - Operations

A taper cutting cycle performs the same four operations as a straight cutting cycle.

However, operation 1 moves the tool from the start point (A) to the position obtained by adding the taper amount to the specified coordinate of the second axis on the plane (specified X-coordinate for the ZX plane) in rapid traverse.

Operations 2, 3, and 4 after operation 1 are the same as for a straight cutting cycle.



**NOTE**

In single block mode, operations 1, 2, 3, and 4 are performed by pressing the cycle start button once.

**- Relationship between the sign of the taper amount and tool path**

The tool path is determined according to the relationship between the sign of the taper amount (address I, J, or K) and the cutting end point in the direction of the length in the absolute or incremental programming as Table 6.3.1.2 (a).

Table 6.3.1.2 (a)

| Outer diameter machining<br>1. $U < 0, W < 0, I < 0$ | Internal diameter machining<br>2. $U > 0, W < 0, I > 0$ |
|--|---|
|  |   |
| 3. $U < 0, W < 0, I > 0$<br>at $ I  \leq  U/2 $      | 4. $U > 0, W < 0, I < 0$<br>at $ I  \leq  U/2 $         |
|  |   |

**- Canceling the mode**

To cancel the canned cycle mode, specify a group 01 G code other than G90, G92, or G94.

**6.3.2 Threading Cycle (G92)**

**6.3.2.1 Straight threading cycle**

**Format**

**G92 X(U)\_Z(W)\_F\_Q\_;**

- X\_,Z\_ : Coordinates of the cutting end point (point A' in the Fig. 6.3.2.1 (a)) in the direction of the length
- U\_,W\_ : Travel distance to the cutting end point (point A' in the Fig. 6.3.2.1 (a)) in the direction of the length
- Q\_ : Angle for shifting the threading start angle  
(Increment: 0.001 degrees, Valid setting range: 0 to 360 degrees)
- F\_ : Thread lead (L in the Fig. 6.3.2.1 (a))

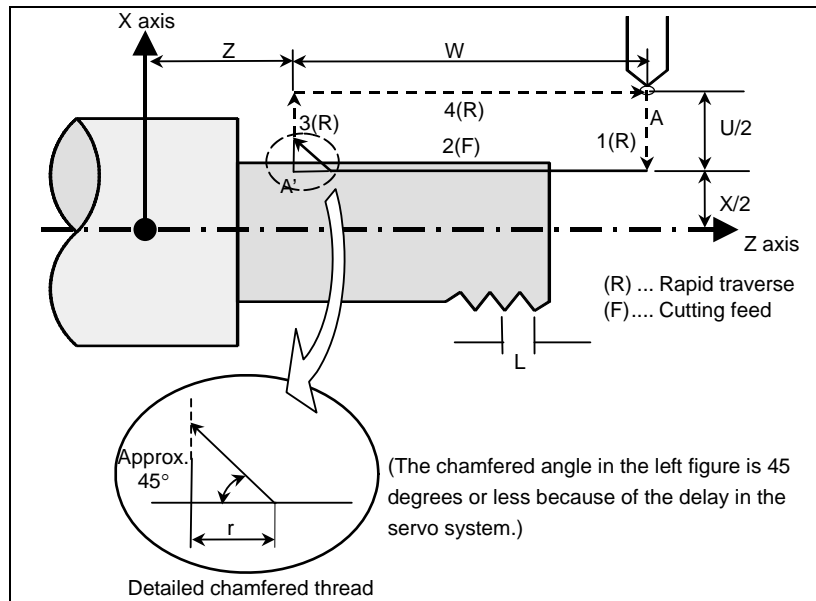

Fig. 6.3.2.1 (a) Straight threading cycle

## Explanation

The ranges of thread leads and restrictions related to the spindle speed are the same as for threading with G32.

### - Operations

A straight threading cycle performs four operations:

- (1) Operation 1 moves the tool from the start point (A) to the specified coordinate of the second axis on the plane (specified X-coordinate for the ZX plane) in rapid traverse.
- (2) Operation 2 moves the tool to the specified coordinate of the first axis on the plane (specified Z-coordinate for the ZX plane) in cutting feed. At this time, thread chamfering is performed.
- (3) Operation 3 moves the tool to the start coordinate of the second axis on the plane (start X-coordinate for the ZX plane) in rapid traverse. (Retraction after chamfering)
- (4) Operation 4 moves the tool to the start coordinate of the first axis on the plane (start Z-coordinate for the ZX plane) in rapid traverse. (The tool returns to the start point (A).)

### ⚠ CAUTION

Notes on this threading are the same as in threading in G32.  
However, a stop by feed hold is as follows; Stop after completion of path 3 of threading cycle.

### NOTE

In the single block mode, operations 1, 2, 3, and 4 are performed by pressing cycle start button once.

### - Canceling the mode

To cancel the canned cycle mode, specify a group 01 G code other than G90, G92, or G94.

### - Acceleration/deceleration for threading after interpolation

Acceleration/deceleration for threading after interpolation is acceleration/deceleration of exponential interpolation type. By setting bit 5 (THLx) of parameter No. 1610, the same acceleration/deceleration as for cutting feed can be selected. (The settings of bits 1 (CTBx) and 0 (CTLx) of parameter No. 1610 are followed.) However, as a time constant and FL feedrate, the settings of parameter No. 1626 and No. 1627 for the threading cycle are used.

### - Time constant and FL feedrate for threading

The time constant for acceleration/deceleration after interpolation for threading specified in parameter No. 1626 and the FL feedrate specified in parameter No. 1627 are used.

The FL feedrate is valid only for exponential acceleration/deceleration after interpolation.

### - Thread chamfering

Thread chamfering can be performed. A signal from the machine tool, initiates thread chamfering. The chamfering distance  $r$  is specified in a range from  $0.1L$  to  $12.7L$  in  $0.1L$  increments by parameter No. 5130. (In the above expression,  $L$  is the thread lead.)

A thread chamfering angle between 1 to 89 degrees can be specified in parameter No. 5131. When a value of 0 is specified in the parameter, an angle of 45 degrees is assumed.

For thread chamfering, the same type of acceleration/deceleration after interpolation, time constant for acceleration/deceleration after interpolation, and FL feedrate as for threading are used.

#### NOTE

Common parameters for specifying the amount and angle of thread chamfering are used for this cycle and threading cycle with G76.

### - Retraction after chamfering

The Table 6.3.2.1 (a) lists the feedrate, type of acceleration/deceleration after interpolation, and time constant of retraction after chamfering.

Table 6.3.2.1 (a)

| Bit 3 (CFR) of parameter No. 1611 | Parameter No. 1466 | Description  |
|-----------------------------------|--------------------|--|
| 0                                 | Other than 0       | Uses the type of acceleration/deceleration after interpolation for threading, time constant for threading (parameter No. 1626), FL feedrate (parameter No. 1627), and retraction feedrate specified in parameter No. 1466.   |
| 0                                 | 0                  | Uses the type of acceleration/deceleration after interpolation for threading, time constant for threading (parameter No. 1626), FL feedrate (parameter No. 1627), and rapid traverse rate specified in parameter No. 1420.   |
| 1                                 |                    | Before retraction a check is made to see that the specified feedrate has become 0 (delay in acceleration/deceleration is 0), and the type of acceleration/deceleration after interpolation for rapid traverse is used together with the rapid traverse time constant and the rapid traverse rate (parameter No. 1420). |

By setting bit 4 (ROC) of parameter No. 1403 to 1, rapid traverse override can be disabled for the feedrate of retraction after chamfering.

#### NOTE

During retraction, the machine does not stop with an override of 0% for the cutting feedrate regardless of the setting of bit 4 (RF0) of parameter No. 1401.

### - Shifting the start angle

Address Q can be used to shift the threading start angle.

The start angle (Q) increment is 0.001 degrees and the valid setting range is between 0 and 360 degrees. No decimal point can be specified.

### - Feed hold in a threading cycle (Threading cycle retract)

When feed hold is applied during threading (operation 2), the tool immediately retracts with chamfering and returns to the start point on the second axis (X-axis), then the first axis (Z-axis) on the plane.

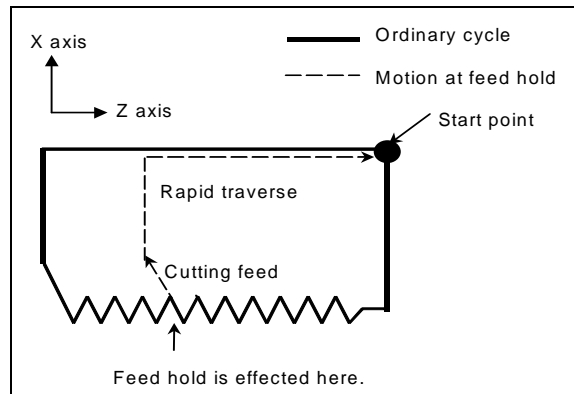

The chamfered angle is the same as that at the end point.

**⚠ CAUTION**

Another feed hold cannot be made during retraction.

**- Inch threading**

Inch threading specified with address E is allowed.

### 6.3.2.2 Taper threading cycle

#### Format

ZpXp-plane

**G92 X(U)\_ Z(W)\_ I\_ F\_ Q\_ ;**

YpZp-plane

**G92 Y(V)\_ Z(W)\_ K\_ F\_ Q\_ ;**

XpYp-plane

**G92 X(U)\_ Y(V)\_ J\_ F\_ Q\_ ;**

X\_,Y\_,Z\_ : Coordinates of the cutting end point (point A' in the Fig. 6.3.2.2 (a)) in the direction of the length

U\_,V\_,W\_ : Travel distance to the cutting end point (point A' in the Fig. 6.3.2.2 (a)) in the direction of the length

Q\_ : Angle for shifting the threading start angle  
(Increment: 0.001 degrees, Valid setting range: 0 to 360 degrees)

I\_,J\_,K : Taper amount (I in the figure below)

F\_ : Thread lead (L in the Fig. 6.3.2.2 (a))

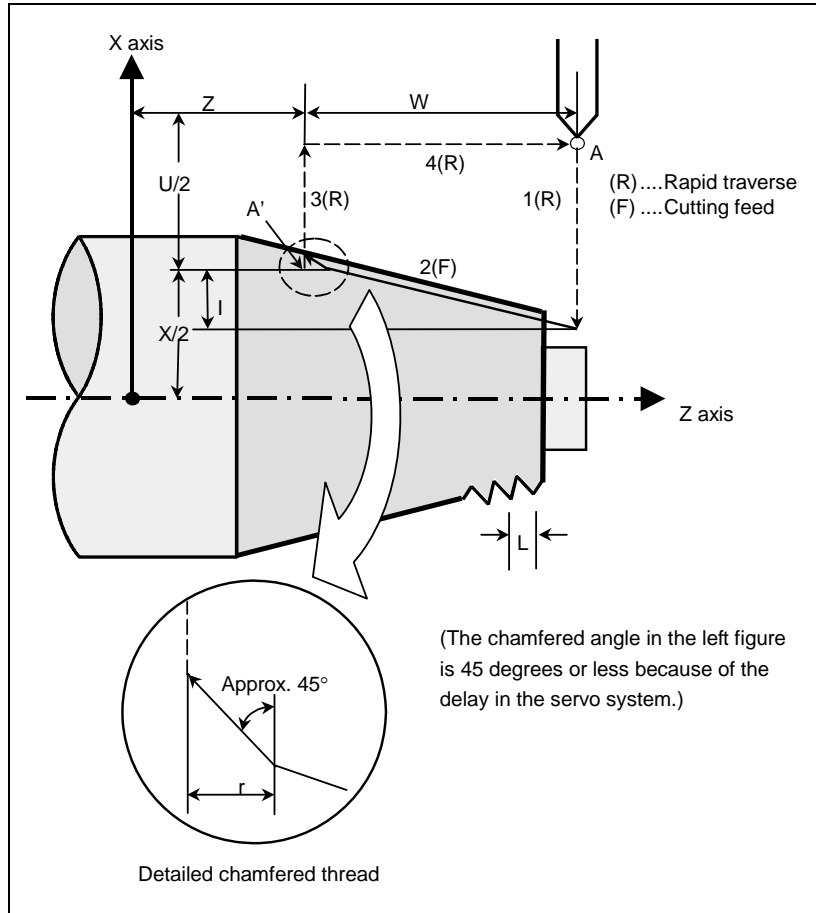

Fig. 6.3.2.2 (a) Taper threading cycle

## Explanation

The ranges of thread leads and restrictions related to the spindle speed are the same as for threading with G32.

The figure of a taper is determined by the coordinates of the cutting end point (A') in the direction of the length and the sign of the taper amount (address I, J, or K). For the cycle in the figure above, a minus sign is added to the taper amount.

### NOTE

The increment system of address I, J, or K for specifying a taper depends on the increment system for the reference axis. Specify a radius value at I, J, or K.

### - Operations

A taper threading cycle performs the same four operations as a straight threading cycle.

However, operation 1 moves the tool from the start point (A) to the position obtained by adding the taper amount to the specified coordinate of the second axis on the plane (specified X-coordinate for the ZX plane) in rapid traverse.

Operations 2, 3, and 4 after operation 1 are the same as for a straight threading cycle.

### ⚠ CAUTION

Notes on this threading are the same as in threading in G32.

However, a stop by feed hold is as follows; Stop after completion of path 3 of threading cycle.

## 6. MEMORY OPERATION

USING Series 10/11 FORMAT PROGRAMMING

B-64604EN-1/01

### NOTE

In the single block mode, operations 1, 2, 3, and 4 are performed by pressing cycle start button once.

### - Relationship between the sign of the taper amount and tool path

The tool path is determined according to the relationship between the sign of the taper amount (address I, J, or K) and the cutting end point in the direction of the length in the absolute or incremental programming as Table 6.3.2.2 (a).

Table 6.3.2.2 (a)

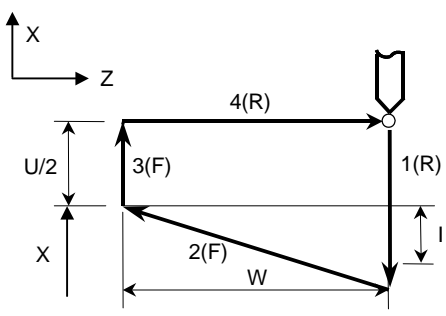
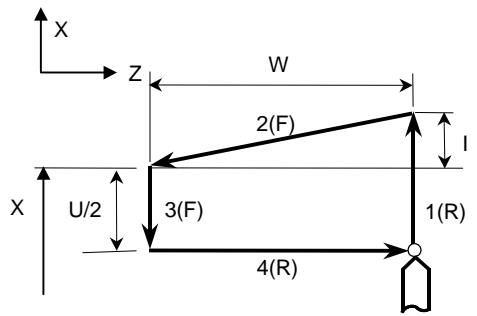
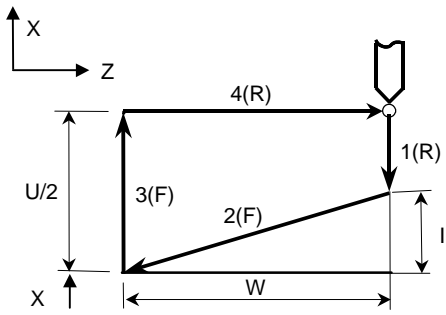
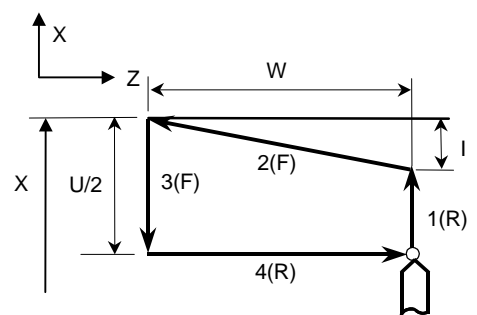
| Outer diameter machining   | Internal diameter machining   |
|--|---|
| <p>1. <math>U &lt; 0, W &lt; 0, I &lt; 0</math></p>                                       | <p>2. <math>U &gt; 0, W &lt; 0, I &gt; 0</math></p>                                       |
| <p>3. <math>U &lt; 0, W &lt; 0, I &gt; 0</math><br/>at <math> I  \leq  U/2 </math></p>  | <p>4. <math>U &gt; 0, W &lt; 0, I &lt; 0</math><br/>at <math> I  \leq  U/2 </math></p>  |

### - Canceling the mode

To cancel the canned cycle mode, specify a group 01 G code other than G90, G92, or G94.

- Acceleration/deceleration for threading after interpolation
- Time constant and FL feedrate for threading
- Thread chamfering
- Retraction after chamfering
- Shifting the start angle
- Threading cycle retract
- Inch threading

See the pages on which a straight threading cycle is explained.

## 6.3.3 End Face Turning Cycle (G94)

### 6.3.3.1 Face cutting cycle

#### Format

**G94 X(U)\_Z(W)\_F\_;**

- X\_,Z\_ : Coordinates of the cutting end point (point A' in the Fig. 6.3.3.1 (a)) in the direction of the end face  
 U\_,W\_ : Travel distance to the cutting end point (point A' in the Fig. 6.3.3.1 (a)) in the direction of the end face  
 F\_ : Cutting feedrate

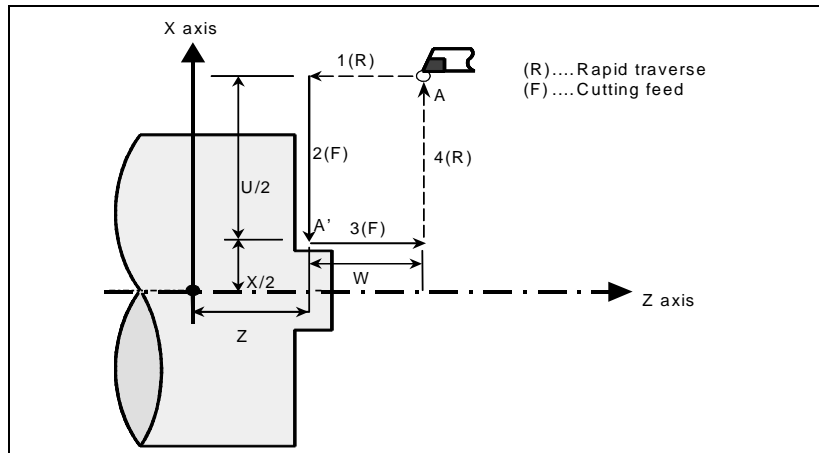

Fig. 6.3.3.1 (a) Face cutting cycle

#### Explanation

##### - Operations

A face cutting cycle performs four operations:

- (1) Operation 1 moves the tool from the start point (A) to the specified coordinate of the first axis on the plane (specified Z-coordinate for the ZX plane) in rapid traverse.
- (2) Operation 2 moves the tool to the specified coordinate of the second axis on the plane (specified X-coordinate for the ZX plane) in cutting feed. (The tool is moved to the cutting end point (A') in the direction of the end face.)
- (3) Operation 3 moves the tool to the start coordinate of the first axis on the plane (start Z-coordinate for the ZX plane) in cutting feed.
- (4) Operation 4 moves the tool to the start coordinate of the second axis on the plane (start X-coordinate for the ZX plane) in rapid traverse. (The tool returns to the start point (A).)

#### NOTE

In single block mode, operations 1, 2, 3, and 4 are performed by pressing the cycle start button once.

##### - Canceling the mode

To cancel the canned cycle mode, specify a group 01 G code other than G90, G92, or G94.

### 6.3.3.2 Taper cutting cycle

#### Format

ZpXp-plane

**G94 X(U)\_ Z(W)\_ K \_ F\_ ;**

YpZp-plane

**G94 Y(V)\_ Z(W)\_ J \_ F\_ ;**

XpYp-plane

**G94 X(U)\_ Y(V)\_ I \_ F\_ ;**

X\_,Y\_,Z\_ : Coordinates of the cutting end point (point A' in the Fig. 6.3.3.2 (a)) in the direction of the end face

U\_,V\_,W\_ : Travel distance to the cutting end point (point A' in the Fig. 6.3.3.2 (a)) in the direction of the end face

I\_,J\_,K\_ : Taper amount (K in the Fig. 6.3.3.2 (a))

F\_ : Cutting feedrate

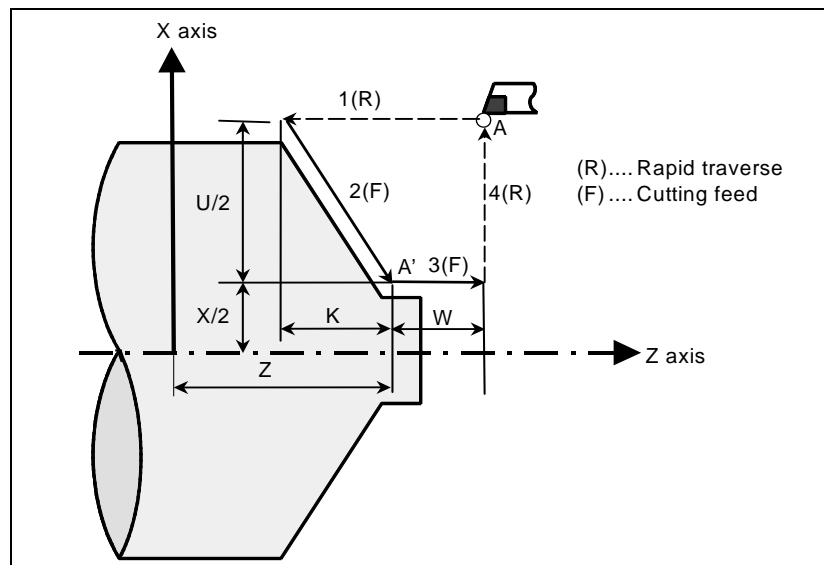

Fig. 6.3.3.2 (a) Taper cutting cycle

#### Explanation

The figure of a taper is determined by the coordinates of the cutting end point (A') in the direction of the end face and the sign of the taper amount (address I, J, or K). For the cycle in the figure above, a minus sign is added to the taper amount.

#### NOTE

The increment system of address I, J, or K for specifying a taper depends on the increment system for the reference axis. Specify a radius value at I, J, or K.

#### - Operations

A taper cutting cycle performs the same four operations as a face cutting cycle.

However, operation 1 moves the tool from the start point (A) to the position obtained by adding the taper amount to the specified coordinate of the first axis on the plane (specified Z-coordinate for the ZX plane) in rapid traverse.

Operations 2, 3, and 4 after operation 1 are the same as for a face cutting cycle.



**NOTE**

In single block mode, operations 1, 2, 3, and 4 are performed by pressing the cycle start button once.

**- Relationship between the sign of the taper amount and tool path**

The tool path is determined according to the relationship between the sign of the taper amount (address I, J, or K) and the cutting end point in the direction of the end face in the absolute or incremental programming as Table 6.3.3.2 (a).

Table 6.3.3.2 (a)

| Outer diameter machining<br>1. $U < 0, W < 0, K < 0$ | Internal diameter machining<br>2. $U > 0, W < 0, K > 0$ |
|--|---|
|  |   |
| 3. $U < 0, W < 0, K > 0$<br>at $ K  \leq  W $        | 4. $U > 0, W < 0, K < 0$<br>at $ K  \leq  W $           |
|  |   |

**- Canceling the mode**

To cancel the canned cycle mode, specify a group 01 G code other than G90, G92, or G94.

## 6.3.4 How to Use Canned Cycles

An appropriate canned cycle is selected according to the shape of the material and the shape of the product.

- **Straight cutting cycle (G90)**

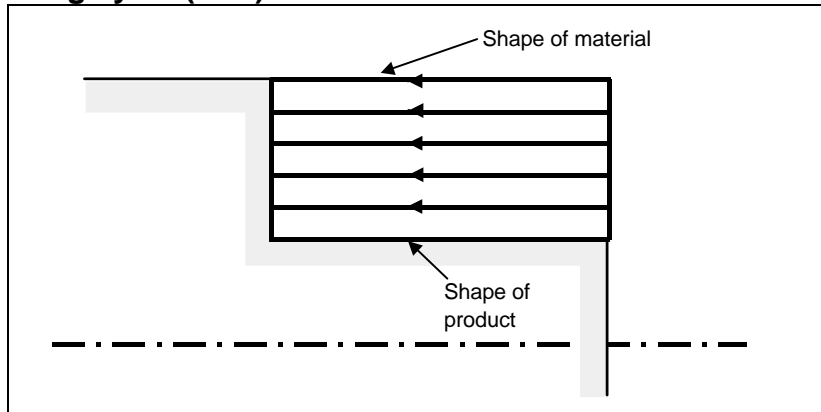

- **Taper cutting cycle (G90)**

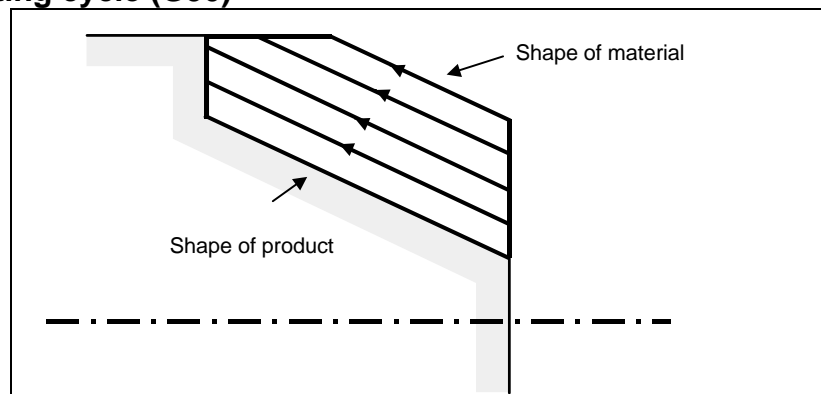

- **Face cutting cycle (G94)**

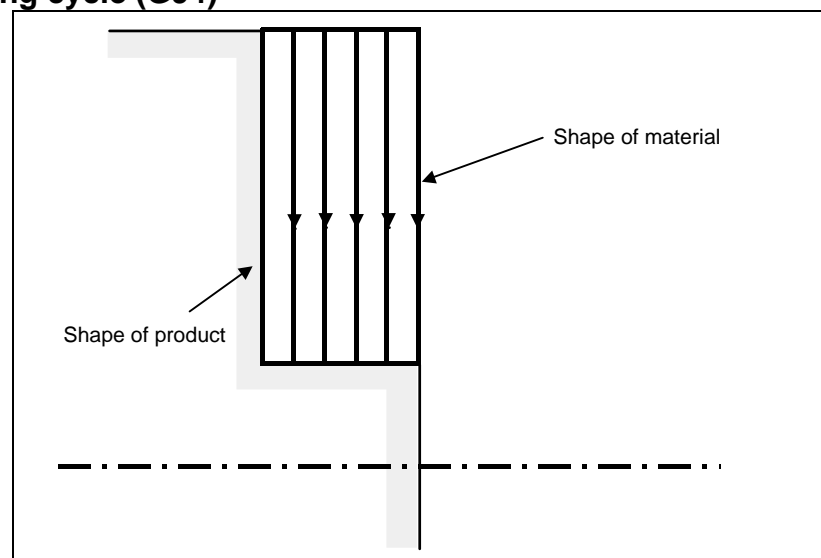

- Face taper cutting cycle (G94)

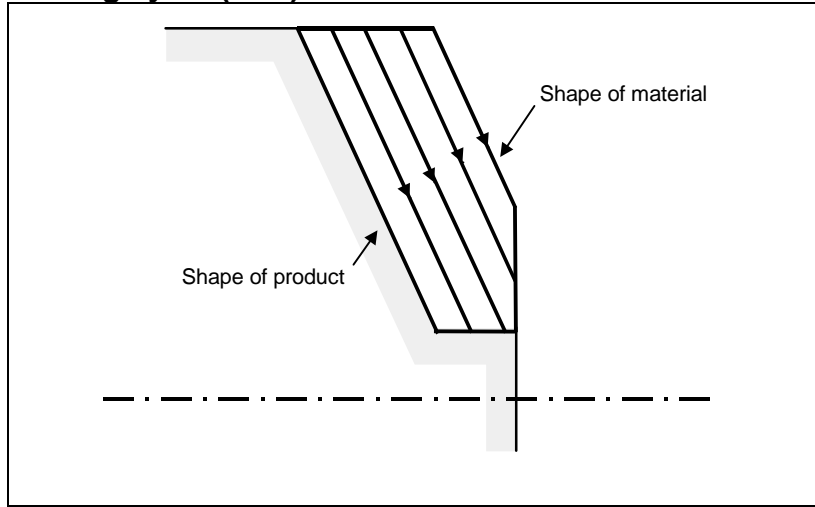

### 6.3.5 Canned Cycle and Tool Nose Radius Compensation

When tool nose radius compensation is applied, the tool nose center path and offset direction are as shown below. At the start point of a cycle, the offset vector is canceled. Offset start-up is performed for the movement from the start point of the cycle. The offset vector is temporarily canceled again at the return to the cycle start point and offset is applied again according to the next move command. The offset direction is determined depending of the cutting pattern regardless of the G41 or G42 mode.

#### Outer diameter/internal diameter cutting cycle (G90)

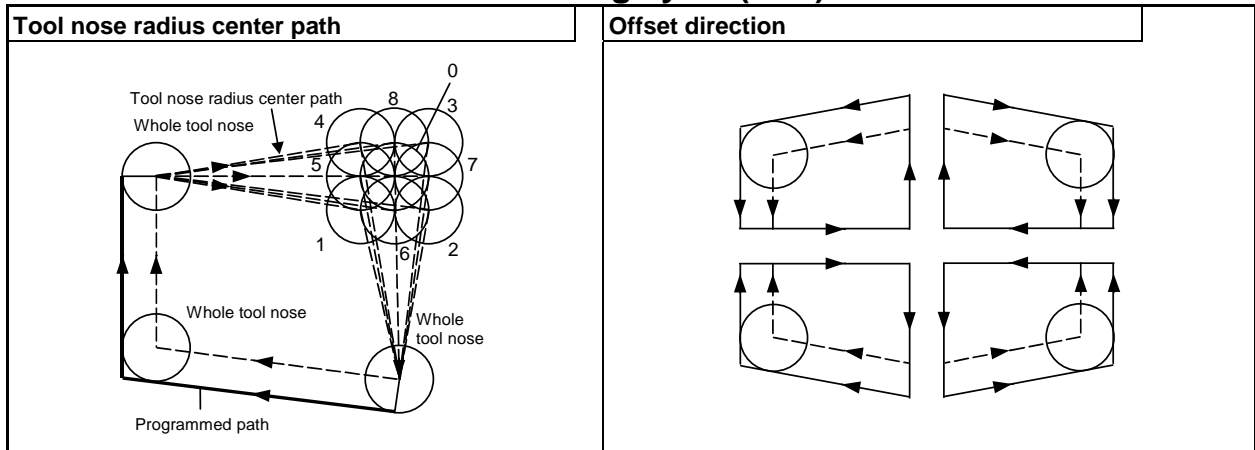

#### End face cutting cycle (G94)

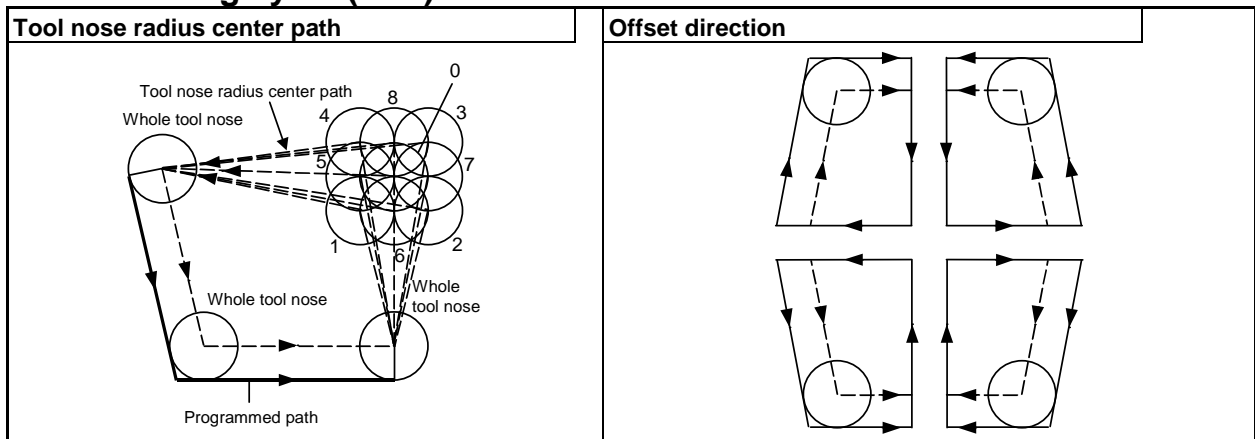

## Threading cycle (G92)

Tool nose radius compensation cannot be applied.

## Differences between Series 0i-F and the Series 0i-C

### NOTE

Series 0i-F is the same as the Series 0i-C in the offset direction, but differs from the series in the tool nose radius center path.

- For Series 0i-F

Cycle operations of a canned cycle are replaced with G00 or G01. In the first block to move the tool from the start point, start-up is performed. In the last block to return the tool to the start point, offset is canceled.

- For the Series 0i-C

This series differs from Series 0i-F in operations in the block to move the tool from the start point and the last block to return it to the start point. For details, refer to "Series 0i-C Operator's Manual."

## How compensation is applied for the Series 0i-C

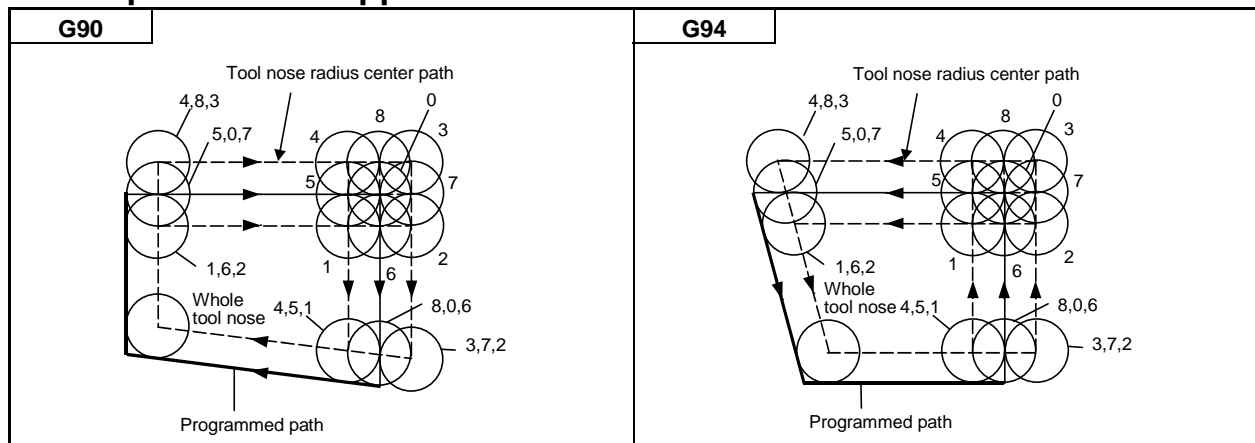

## 6.3.6 Restrictions on Canned Cycles

### Limitation

- **Modal**

Since data items X (U), Z (W), and R in a canned cycle are modal values common to G90, G92, and G94. For this reason, if a new X (U), Z (W), or R value is not specified, the previously specified value is effective.

Thus, when the travel distance along the Z-axis does not vary as shown in the program example below, a canned cycle can be repeated only by specifying the travel distance along the X-axis.

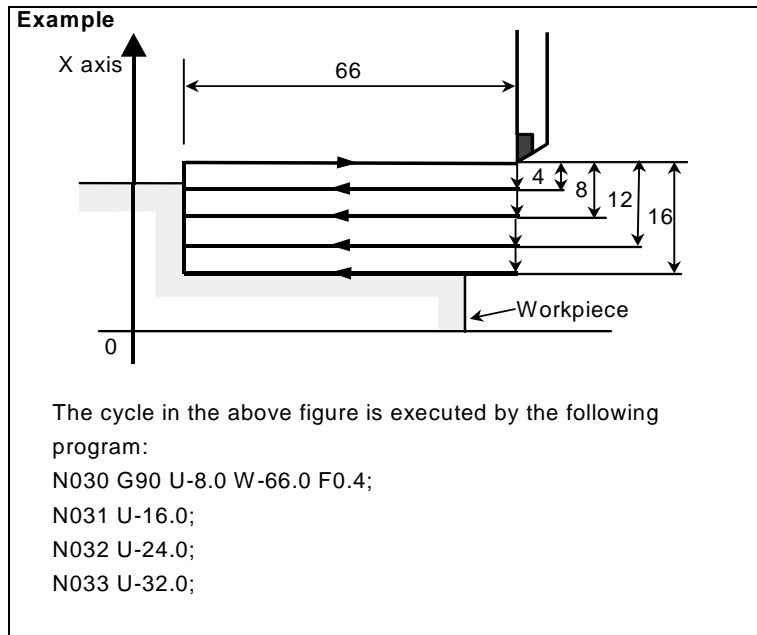

The modal values common to canned cycles are cleared when a one-shot G code other than G04 is specified.

Since the canned cycle mode is not canceled by specifying a one-shot G code, a canned cycle can be performed again by specifying modal values. If no modal values are specified, no cycle operations are performed.

When G04 is specified, G04 is executed and no canned cycle is performed.

#### - Block in which no move command is specified

In a block in which no move command is specified in the canned cycle mode, a canned cycle is also performed. For example, a block containing only EOB or a block in which none of the M, S, and T codes, and move commands are specified is of this type of block. When an M, S, or T code is specified in the canned cycle mode, the corresponding M, S, or T function is executed together with the canned cycle. If this is inconvenient, specify a group 01 G code (G00 or G01) other than G90, G92, or G94 to cancel the canned cycle mode, and specify an M, S, or T code, as in the program example below. After the corresponding M, S, or T function has been executed, specify the canned cycle again.

#### Example

```

N003 T0101;
:
:
N010 G90 X20.0 Z10.0 F0.2;
N011 G00 T0202;           ← Cancels the canned cycle mode.
N012 G90 X20.5 Z10.0;

```

#### - Plane selection command

Specify a plane selection command (G17, G18, or G19) before setting a canned cycle or specify it in the block in which the first canned cycle is specified.

If a plane selection command is specified in the canned cycle mode, the command is executed, but the modal values common to canned cycles are cleared.

If an axis which is not on the selected plane is specified, alarm PS0330 is issued.

#### - Parallel axis

When G code system A is used, U, V, and W cannot be specified as a parallel axis.

### - Reset

If a reset operation is performed during execution of a canned cycle when any of the following states for holding a modal G code of group 01 is set, the modal G code of group 01 is replaced with the G01 mode:

- Reset state (bit 6 (CLR) of parameter No. 3402 = 0)
- Cleared state (bit 6 (CLR) of parameter No. 3402 = 1) and state where the modal G code of group 01 is held at reset time (bit 1 (C01) of parameter No. 3406 = 1)

Example of operation)

If a reset is made during execution of a canned cycle (X0 block) and the X20.Z1. command is executed, linear interpolation (G01) is performed instead of the canned cycle.

### - Manual intervention

After manual intervention is performed with the manual absolute on command before the execution of a canned cycle or after the stop of the execution, when a cycle operation starts, the manual intervention amount is canceled even with an incremental cycle start command.

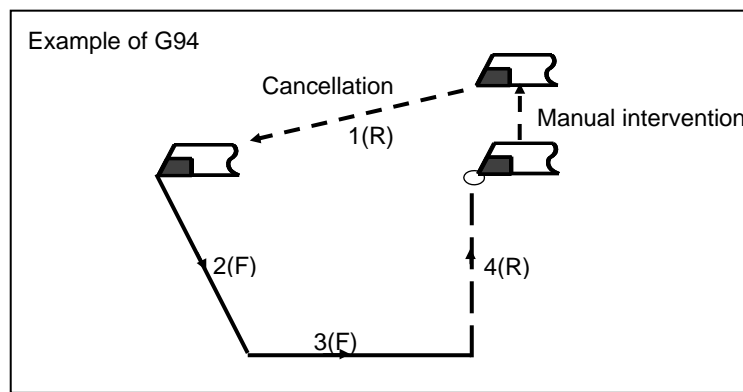

## 6.4 MULTIPLE REPETITIVE CANNED CYCLE

---

The multiple repetitive canned cycle is canned cycles to make CNC programming easy. For instance, the data of the finish workpiece shape describes the tool path for rough machining. And also, a canned cycles for the threading is available.

### NOTE

- 1 When bit 3 (NMR) of parameter No.8137 is 0, "Multiple repetitive canned cycle" can be used.  
Though, a canned grinding cycle and multiple repetitive canned cycle cannot be used simultaneously. When the canned grinding cycle (the option, "Grinding function A" or "Grinding function B") is enabled, the multiple repetitive canned cycle is disabled.
- 2 Explanatory figures in this section use the ZX plane as the selected plane, diameter programming for the X-axis, and radius programming for the Z-axis. When radius programming is used for the X-axis, change U/2 to U and X/2 to X.
- 3 A multiple repetitive canned cycle can be performed on any plane (including parallel axes for plane definition). When G code system A is used, however, U, V, and W cannot be set as a parallel axis.

## 6.4.1 Stock Removal in Turning (G71)

There are two types of stock removal in turning : Type I and II.

### Format

ZpXp plane

**G71 P(ns) Q(nf) U( $\Delta u$ ) W( $\Delta w$ ) I( $\Delta i$ ) K( $\Delta k$ ) D( $\Delta d$ ) F(f) S(s) T(t) ;**

**N (ns) ;**

...

**N (nf) ;**

The move command between A and B is specified in the blocks from sequence number ns to nf.

YpZp plane

**G71 P(ns) Q(nf) V( $\Delta w$ ) W( $\Delta u$ ) J( $\Delta k$ ) K( $\Delta i$ ) D( $\Delta d$ ) F(f) S(s) T(t) ;**

**N (ns) ;**

...

**N (nf) ;**

XpYp plane

**G71 P(ns) Q(nf) U( $\Delta w$ ) V( $\Delta u$ ) I( $\Delta k$ ) J( $\Delta i$ ) D( $\Delta d$ ) F(f) S(s) T(t) ;**

**N (ns) ;**

...

**N (nf) ;**

$\Delta d$  : Depth of cut

The cutting direction depends on the direction AA'.

ns : Sequence number of the first block for the program of finishing shape.

nf : Sequence number of the last block for the program of finishing shape.

$\Delta u$  : Distance of the finishing allowance in the direction of the second axis on the plane (X-axis for the ZX plane)

$\Delta w$  : Distance of the finishing allowance in the direction of the first axis on the plane (Z-axis for the ZX plane)

$\Delta i$  : Distance of the finishing allowance of the roughing in the direction of the second axis on the plane (X-axis for the ZX plane)

$\Delta k$  : Distance of the finishing allowance of the roughing in the direction of the first axis on the plane (Z-axis for the ZX plane)

f,s,t : Any F, S, or T function contained in blocks ns to nf in the cycle is ignored, and the F, S, or T function in this G71 block is effective.

### NOTE

Even if pocket calculator type decimal point programming is specified (bit 0 (DPI) of parameter No. 3401 = 1), the unit of address D is least input increment. In addition, when a decimal point is input in address D, the alarm PS0007 is issued.

|            | Unit  | Diameter/radius programming  | Sign         | Decimal point input |
|------------|---|--|--------------|---------------------|
| $\Delta d$ | Depends on the increment system for the reference axis. | Radius programming   | Not required | Not allowed         |
| $\Delta u$ | Depends on the increment system for the reference axis. | Depends on diameter/radius programming for the second axis on the plane. | Required     | Allowed             |



|            | Unit  | Diameter/radius programming   | Sign         | Decimal point input |
|------------|---|---|--------------|---------------------|
| $\Delta w$ | Depends on the increment system for the reference axis. | Depends on diameter/radius programming for the first axis on the plane. | Required     | Allowed             |
| $\Delta i$ | Depends on the increment system for the reference axis. | Radius programming  | Not required | Allowed             |
| $\Delta k$ | Depends on the increment system for the reference axis. | Radius programming  | Not required | Allowed             |

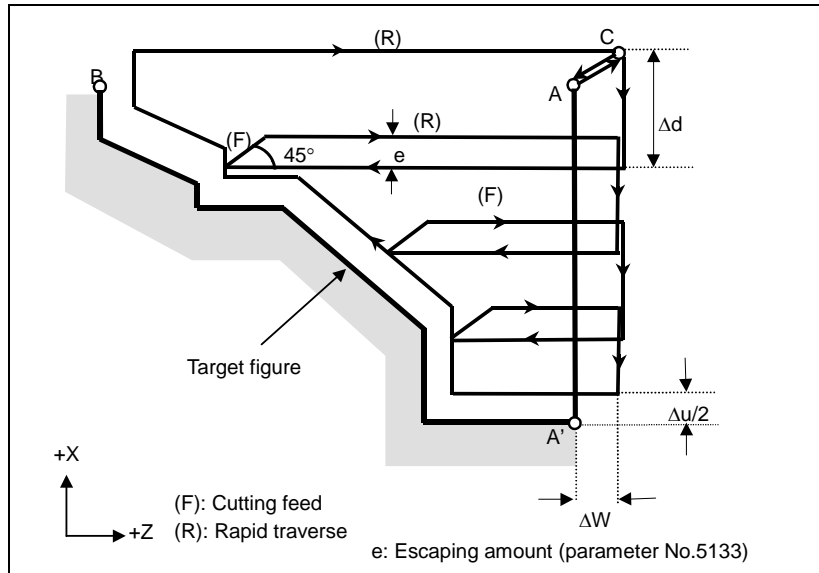

**Fig. 6.4.1 (a) Cutting path of an outer surface rough cutting cycle without rough cutting finishing allowance (type I)**

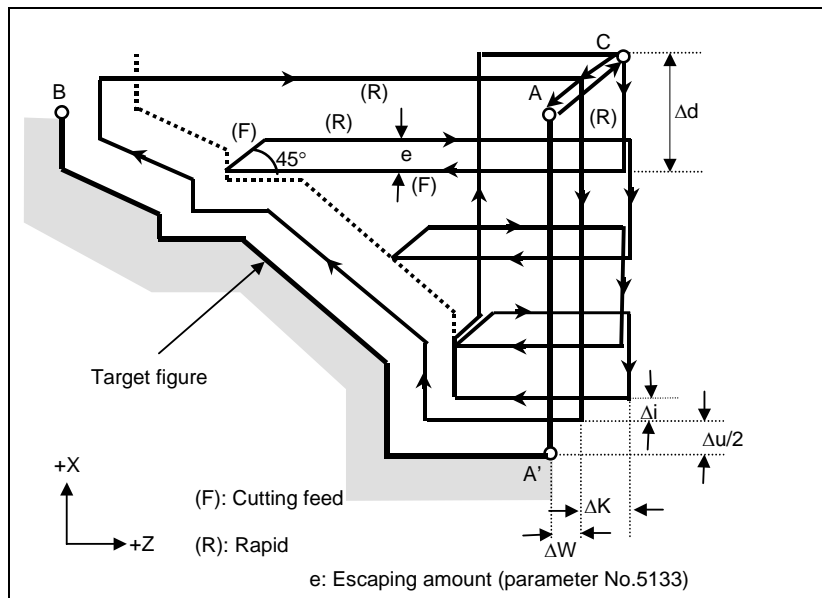

**Fig. 6.4.1 (b) Cutting path of an outer surface rough cutting cycle with rough cutting finishing allowance (type I)**

**Explanation**

**- Operations**

If a target figure passing through A, A', and B in this order is given by the program, a workpiece is cut away by depth of cut  $\Delta d$  at a time. The machining path varies as follows depending on whether the rough machining finishing allowance is specified.

## 6. MEMORY OPERATION

- (1) When the rough cutting finishing allowance is not specified  
Cutting is performed by depth of cut  $\Delta d$  with finishing allowances  $\Delta u/2$  and  $\Delta w$  left, and rough cutting as finishing is performed according to the target figure program after the last machining.
  - (2) When the rough cutting finishing allowance is specified  
Cutting is performed by depth of cut  $\Delta d$  with cutting allowances  $\Delta u/2 + \Delta i$  and  $\Delta w + \Delta k$  left, and the tool returns to the start point (A) after the last cutting is performed. Then, rough machining as finishing is performed along the target figure to remove cutting allowances  $\Delta i$  and  $\Delta k$ .
- Upon completion of rough machining as finishing, the block next to the sequence block specified by Q is executed.

### NOTE

- 1 F, S, and T functions which are specified in the move command between points A and B are ineffective and those specified in G71 block or the previous block are effective. M and second auxiliary functions are treated in the same way as F, S, and T functions.
- 2 When a constant surface speed control is enabled (bit 0 (SSC) of parameter No. 8133 is set to 1), G96 or G97 command specified in the move command between points A and B are ineffective, and that specified in G71 block or the previous block is effective.

### - Escaping amount (e)

The escaping amount (e) is set in parameter No. 5133.

| No.  | Unit  | Diameter/radius programming | Sign         |
|------|---|-----------------------------|--------------|
| 5133 | Depends on the increment system for the reference axis. | Radius programming          | Not required |

### - Target figure Patterns

The following four cutting patterns are considered. All of these cutting cycles cut the workpiece with moving the tool in parallel to the first axis on the plane (Z-axis for the ZX plane). At this time, the signs of the finishing allowances of  $\Delta u$  and  $\Delta w$  are as follows:

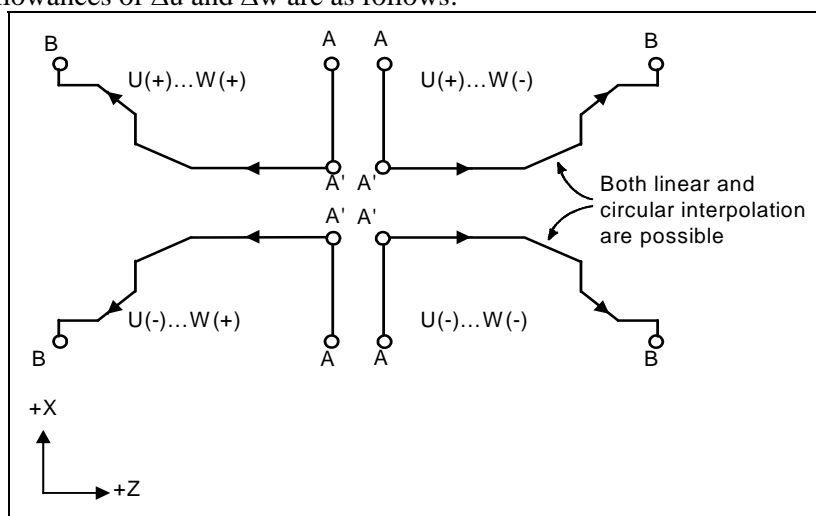

Fig. 6.4.1 (c) Four target figure patterns

### Limitation

- (1) For U(+), a figure for which a position higher than the cycle start point is specified cannot be machined.

For U(-), a figure for which a position lower than the cycle start point is specified cannot be machined.

- (2) For type I, the figure must show monotone increase or decrease along the first and second axes on the plane.
- (3) For type II, the figure must show monotone increase or decrease along the first axis on the plane.

### Start block

In the start block in the program for a target figure (block with sequence number ns in which the path between A and A' is specified), G00 or G01 must be specified. If it is not specified, alarm PS0065 is issued.

When G00 is specified, positioning is performed along A-A'. When G01 is specified, linear interpolation is performed with cutting feed along A-A'.

In this start block, also select type I or II.

If X-axis does not move at start block, alarm PS0325 "UNAVAILABLE COMMAND IS IN SHAPE PROGRAM" is issued.

### Check functions

During cycle operation, whether the target figure shows monotone increase or decrease is always checked.

#### NOTE

When tool nose radius compensation is applied, the target figure to which compensation is applied is checked.

The following checks can also be made.

| Check  | Related parameter   |
|--|---|
| Checks that a block with the sequence number specified at address Q is contained in the program before cycle operation.                      | Enabled when bit 2 (QSR) of parameter No. 5102 is set to 1. |
| Checks the target figure before cycle operation.<br>(Also checks that a block with the sequence number specified at address Q is contained.) | Enabled when bit 2 (FCK) of parameter No. 5104 is set to 1. |

### - Types I and II

#### Selection of type I or II

For G71, there are types I and II.

When the target figure has pockets, be sure to use type II.

Escaping operation after rough cutting in the direction of the first axis on the plane (Z-axis for the ZX plane) differs between types I and II. With type I, the tool escapes to the direction of 45 degrees. With type II, the tool cuts the workpiece along the target figure. When the target figure has no pockets, determine the desired escaping operation and select type I or II.

#### Selecting type I or II

In the start block for the target figure (sequence number ns), select type I or II.

- (1) When type I is selected  
Specify the second axis on the plane (X-axis for the ZX plane). Do not specify the first axis on the plane (Z-axis for the ZX plane).
- (2) When type II is selected  
Specify the second axis on the plane (X-axis for the ZX plane) and first axis on the plane (Z-axis for the ZX plane).  
When you want to use type II without moving the tool along the first axis on the plane (Z-axis for the ZX plane), specify the incremental programming with travel distance 0 (W0 for the ZX plane).

- **Type I**

- (1) In the block with sequence number ns, only the second axis on the plane (X-axis (U-axis) for the ZX plane) must be specified.

**Example**

```
ZX plane  
G71 V10.0 R5.0 ;  
G71 P100 Q200...;  
N100 X(U)_ ;      (Specifies only the second axis on the plane.)  
      : ;  
      : ;  
      : ;  
      : ;  
N200.....;
```

- (2) The figure along path A'-B must show monotone increase or decrease in the directions of both axes forming the plane (Z- and X-axes for the ZX plane). It must not have any pocket as shown in the Fig. 6.4.1 (d).

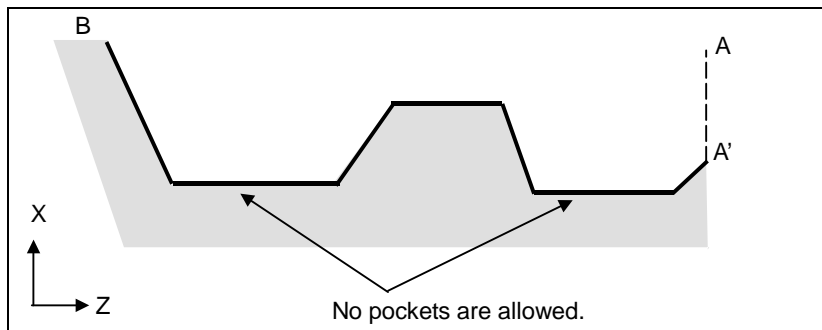

Fig. 6.4.1 (d) Figure which does not show monotone increase or decrease (type I)

**CAUTION**

If a figure does not show monotone change along the first or second axis on the plane, alarm PS0064 or 0329 is issued. If the movement does not show monotone change, but is very small, and it can be determined that the movement is not dangerous, however, the permissible amount can be specified in parameters Nos. 5145 and 5146 to specify that the alarm is not issued in this case.

- (3) The tool escapes to the direction of 45 degrees in cutting feed after rough cutting.

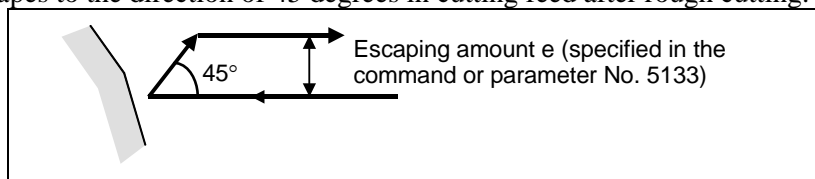

Fig. 6.4.1 (e) Cutting in the direction of 45 degrees (type I)

- (4) Immediately after the last cutting, rough cutting is performed as finishing along the target figure. Bit 1 (RF1) of parameter No. 5105 can be set to 1 so that rough cutting as finishing is not performed. When the rough cutting finishing allowance is specified, however, rough cutting as finishing is performed.

## - Type II

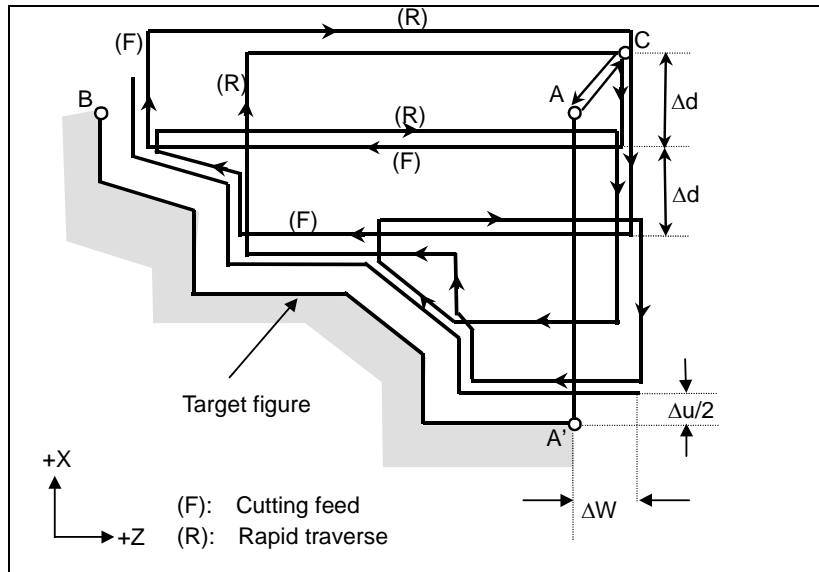

Fig. 6.4.1 (f) Cutting path in stock removal in turning (type II)

When the figure program for instructing a target figure passing through A, A', and B in this order is specified, a workpiece is cut away by depth of cut  $\Delta d$  at a time. In type II, cutting is performed along the figure after rough cutting in the direction of the plane first axis (z-axis for the ZX plane).

The machining path varies as follows depending on whether the rough machining finishing allowance is specified.

- (1) When the rough cutting finishing allowance is not specified

Cutting is performed by depth of cut  $\Delta d$  with finishing allowances  $\Delta u/2$  and  $\Delta w$  left, and the tool returns to the start point (A) after the last cutting is performed (one pocket is assumed because  $P_n \rightarrow P_m$  is parallel to the z-axis in the Fig. 6.4.1 (f), and the zone is cut). Then, rough machining as finishing is performed according to the finishing figure program with finishing allowances  $\Delta u/2$  and  $\Delta w$  left.

- (2) When the rough cutting finishing allowance is specified

Cutting is performed by depth of cut  $\Delta d$  with cutting allowances  $\Delta u/2 + \Delta i$  and  $\Delta w + \Delta k$  left, and the tool returns to the start point (A) after the last cutting is performed. Then, rough machining as finishing is performed along the target figure to remove cutting allowances  $\Delta i$  and  $\Delta k$ .

Upon completion of rough machining as finishing, the block next to the sequence block specified by Q is executed.

Type II differs from type I in the following points:

- (1) In the block with sequence number ns, the two axes forming the plane (X-axis (U-axis) and Z-axis (W-axis) for the ZX plane) must be specified. When you want to use type II without moving the tool along the Z-axis on the ZX plane in the first block, specify W0.

**Example**

```
ZX plane
G71 V10.0 R5.0;
G71 P100 Q200.....;
N100 X(U)_ Z(W)_ ;   (Specifies the two axes forming the plane.)
      :
      :
      :
N200.....;
```

- (2) The figure need not show monotone increase or decrease in the direction of the second axis on the plane (X-axis for the ZX plane) and it may have concaves (pockets).

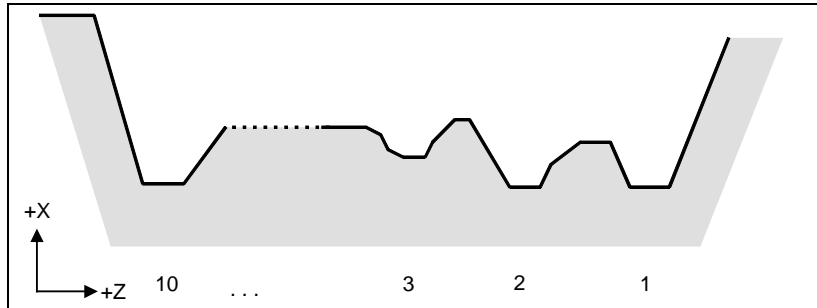

Fig. 6.4.1 (g) Figure having pockets (type II)

The figure must show monotone change in the direction of the first axis on the plane (Z-axis for the ZX plane), however. The following figure cannot be machined.

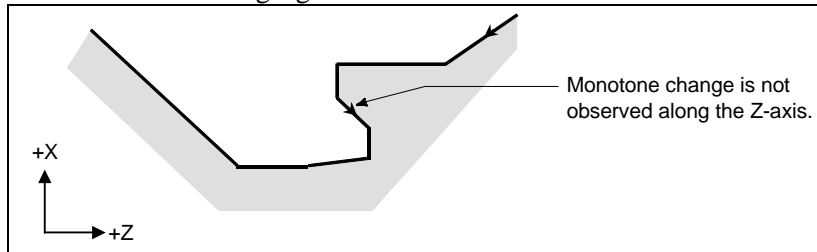

Fig. 6.4.1 (h) Figure which cannot be machined (type II)

**CAUTION**

For a figure along which the tool moves backward along the first axis on the plane during cutting operation (including a vertex in an arc command), the cutting tool may contact the workpiece. For this reason, for a figure which does not show monotone change, alarm PS0064 or PS0329 is issued. If the movement does not show monotone change, but is very small, and it can be determined that the movement is not dangerous, however, the permissible amount can be specified in parameter No. 5145 to specify that the alarm is not issued in this case.

The first cut portion need not be vertical. Any figure is permitted if monotone change is shown in the direction of the first axis on the plane (Z-axis for the ZX plane).

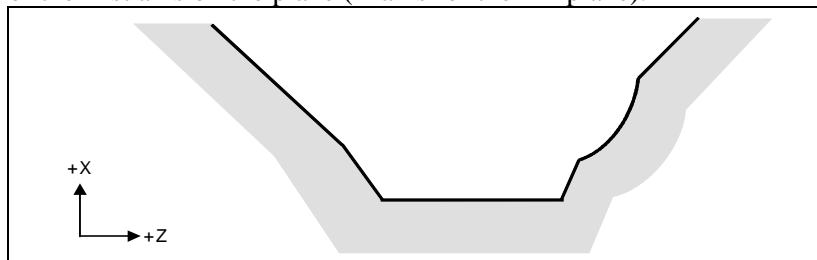

Fig. 6.4.1 (i) Figure which can be machined (type II)

- (3) After turning, the tool cuts the workpiece along its figure and escapes in cutting feed.

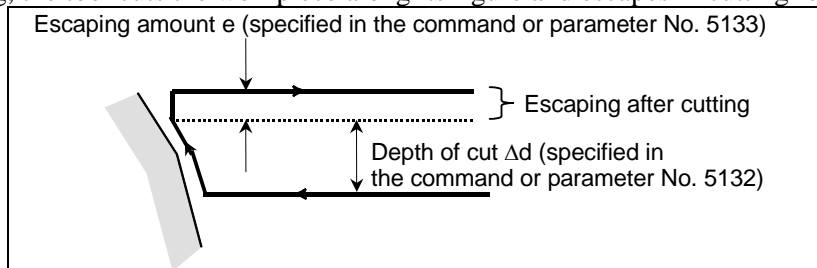

Fig. 6.4.1 (j) Cutting along the workpiece figure (type II)

The escaping amount  $e$  after cutting is set in parameter No. 5133.  
When moving from the bottom, however, the tool escapes to the direction of 45 degrees.

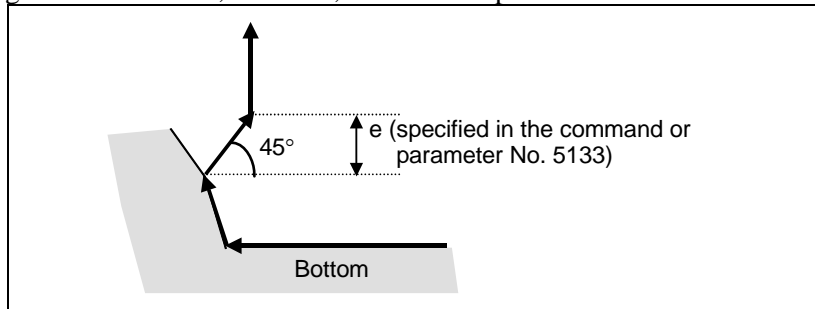

Fig. 6.4.1 (k) Escaping from the bottom to the direction of 45 degrees

- (4) When a position parallel to the first axis on the plane (Z-axis for the ZX plane) is specified in a block in the program for the target figure, it is assumed to be at the bottom of a pocket.
- (5) After all rough cutting terminates along the first axis on the plane (Z-axis for the ZX plane), the tool temporarily returns to the cycle start point. At this time, when there is a position whose height equals to that at the start point, the tool passes through the point in the position obtained by adding depth of cut  $\Delta d$  to the position of the figure and returns to the start point.

Then, rough cutting is performed as finishing along the target figure. At this time, the tool passes through the point in the obtained position (to which depth of cut  $\Delta d$  is added) when returning to the start point.

Bit 2 (RF2) of parameter No. 5105 can be set to 1 so that rough cutting as finishing is not performed.

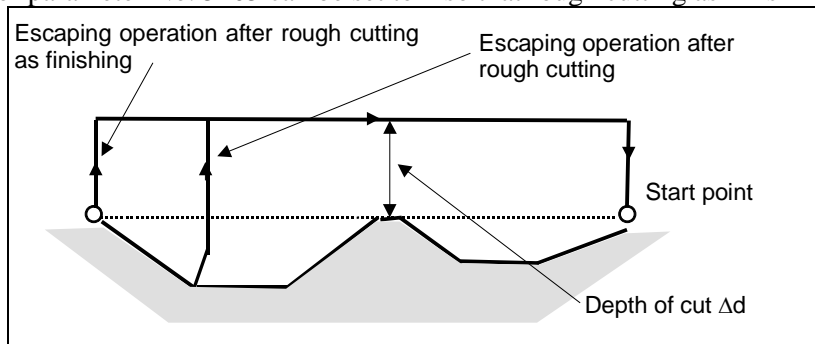

Fig. 6.4.1 (l) Escaping operation when the tool returns to the start point (type II)

- (6) Order and path for rough cutting of pockets  
Rough cutting is performed in the following order.

- (a) When the figure shows monotone decrease along the first axis on the plane (Z-axis for the ZX plane)

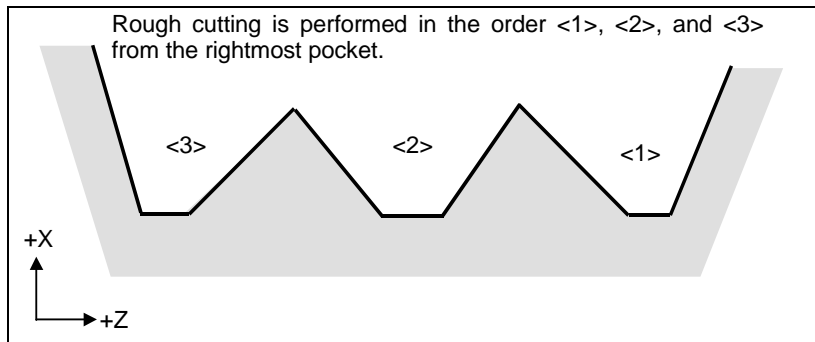

Fig. 6.4.1 (m) Rough cutting order in the case of monotone decrease (type II)

- (b) When the figure shows monotone increase along the first axis on the plane (Z-axis for the ZX plane)

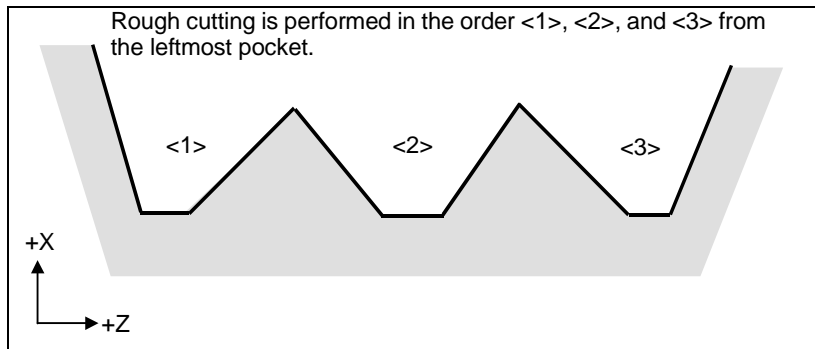

Fig. 6.4.1 (n) Rough cutting order in the case of monotone increase (type II)

The path in rough cutting is as shown Fig. 6.4.1 (o).

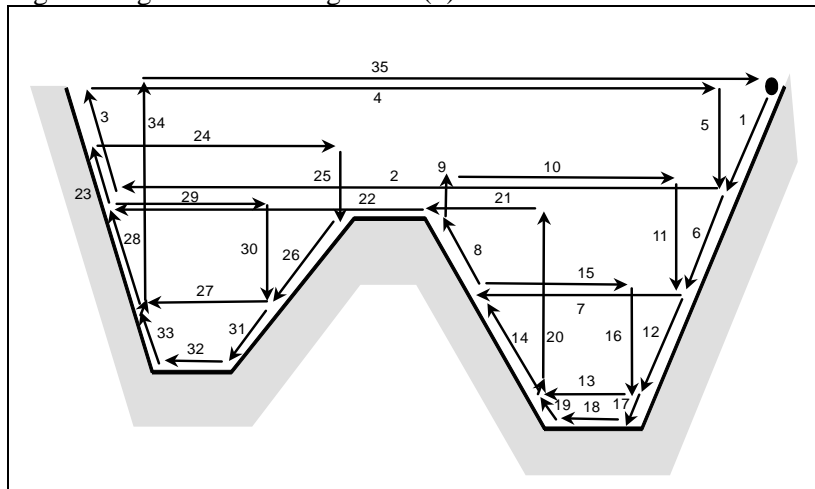

Fig. 6.4.1 (o) Cutting path for multiple pockets (type II)

The Fig. 6.4.1 (p) shows how the tool moves after rough cutting for a pocket in detail.

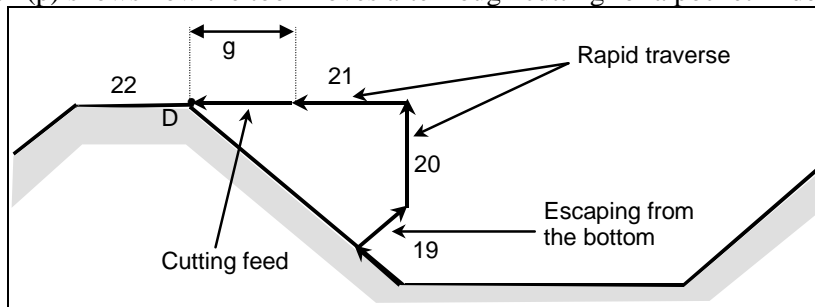

Fig. 6.4.1 (p) Details of motion after cutting for a pocket (type II)

Cuts the workpiece at the cutting feedrate and escapes to the direction of 45 degrees. (Operation 19)

Then, moves to the height of point D in rapid traverse. (Operation 20)

Then, moves to the position the amount of g before point D. (Operation 21)

Finally, moves to point D in cutting feed.

The clearance g to the cutting feed start position is set in parameter No. 5134.

For the last pocket, after cutting the bottom, the tool escapes to the direction of 45 degrees and returns to the start point in rapid traverse. (Operations 34 and 35)

**CAUTION**

- 1 This CNC differs from the Series 0i-C in cutting of a pocket.  
The tool first cuts the nearest pocket to the start point. After cutting of the pocket terminates, the tool moves to the nearest but one pocket and starts cutting.



**⚠ CAUTION**

- 2 When the figure has a pocket, generally specify a value of 0 for  $\Delta w$  (finishing allowance). Otherwise, the tool may dig into the wall on one side.
- 3 This CNC differs from the Series 0i-C in the path of cutting after turning depending on the figure of the workpiece. When the tool becomes moving only along the first axis on the plane (Z-axis for the ZX plane) according to the figure of the workpiece during cutting, it starts retraction along the second axis on the plane (X-axis for the ZX plane).

About bit 0 (R16) of parameter No. 5108, please refer to the explanations of Stock Removal in Turning (G71) in [FUNCTIONS TO SIMPLIFY PROGRAMMING].

**- Tool nose radius compensation**

Please refer to the explanations of Stock Removal in Turning (G71) in [FUNCTIONS TO SIMPLIFY PROGRAMMING].

**- Reducing the cycle time**

Please refer to the explanations of Stock Removal in Turning (G71) in [FUNCTIONS TO SIMPLIFY PROGRAMMING].

## 6.4.2 Stock Removal in Facing (G72)

This cycle is the same as G71 except that cutting is performed by an operation parallel to the second axis on the plane (X-axis for the ZX plane).

### Format

ZpXp plane

**G72 P(ns) Q(nf) U(Du) W(Dw) I(Di) K(Dk) D(Dd) F(f) S(s) T(t);**

**N (ns) ;**

...

**N (nf) ;**

} The move command between A and B is specified in the blocks from sequence number ns to nf.

YpZp plane

**G72 P(ns) Q(nf) V( $\Delta w$ ) W( $\Delta u$ ) J( $\Delta k$ ) K( $\Delta i$ ) D( $\Delta d$ ) F(f) S(s) T(t);**

**N (ns) ;**

...

**N (nf) ;**

XpYp plane

**G72 P(ns) Q(nf) U( $\Delta w$ ) V( $\Delta u$ ) I( $\Delta k$ ) J( $\Delta i$ ) D( $\Delta d$ ) F(f) S(s) T(t);**

**N (ns) ;**

...

**N (nf) ;**

$\Delta d$  : Depth of cut

The cutting direction depends on the direction AA'.

ns : Sequence number of the first block for the program of finishing shape.

nf : Sequence number of the last block for the program of finishing shape.

$\Delta u$  : Distance of the finishing allowance in the direction of the second axis on the plane (X-axis for the ZX plane)

$\Delta w$  : Distance of the finishing allowance in the direction of the first axis on the plane (Z-axis for the ZX plane)

$\Delta i$  : Distance of the finishing allowance of the roughing in the direction of the second axis on the plane (X-axis for the ZX plane)

$\Delta k$  : Distance of the finishing allowance of the roughing in the direction of the first axis on the plane (Z-axis for the ZX plane)

f,s,t : Any F, S, or T function contained in blocks ns to nf in the cycle is ignored, and the F, S, or T function in this G72 block is effective.

### NOTE

Even if pocket calculator type decimal point programming is specified bit 0 (DPI) of parameter No. 3401 = 1, the unit of address D is least input increment. In addition, when a decimal point is input in address D, the alarm PS0007, "ILLEGAL USE OF DECIMAL POINT" is issued.

|            | Unit  | Diameter/radius programming  | Sign         | Decimal point input |
|------------|---|--|--------------|---------------------|
| $\Delta d$ | Depends on the increment system for the reference axis. | Radius programming   | Not required | Not allowed         |
| $\Delta u$ | Depends on the increment system for the reference axis. | Depends on diameter/radius programming for the second axis on the plane. | Required     | Allowed             |
| $\Delta w$ | Depends on the increment system for the reference axis. | Depends on diameter/radius programming for the first axis on the plane.  | Required     | Allowed             |
| $\Delta i$ | Depends on the increment system for the reference axis. | Radius programming   | Not required | Allowed             |
| $\Delta k$ | Depends on the increment system for the reference axis. | Radius programming   | Not required | Allowed             |

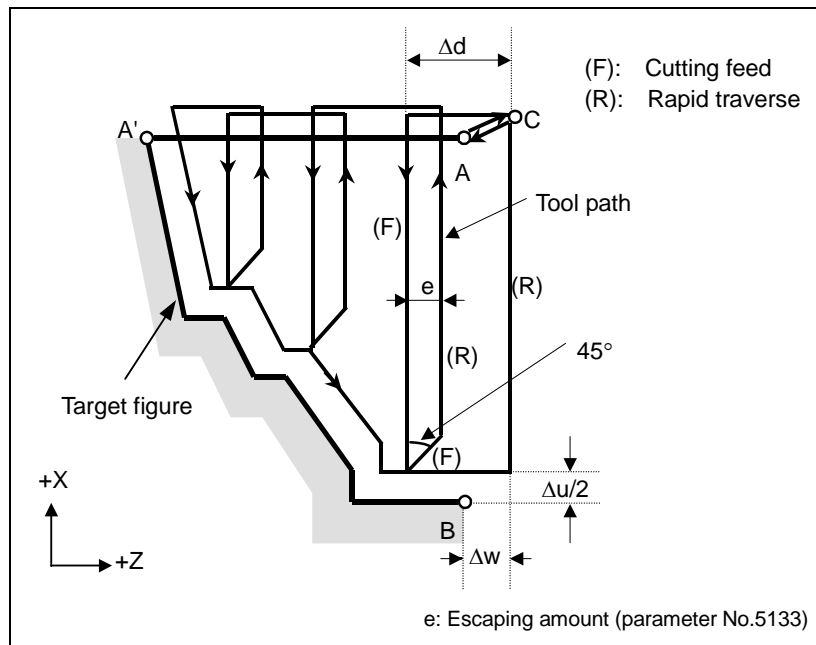

Fig. 6.4.2 (a) Cutting path in stock removal in facing (type I)

## Explanation

### - Operations

When a target figure passing through A, A', and B in this order is given by a program, the specified area is removed by  $\Delta d$  (depth of cut), with the finishing allowance specified by  $\Delta u/2$  and  $\Delta w$  left.

### NOTE

- 1 F, S, and T functions which are specified in the move command between points A and B are ineffective and those specified in G72 block or the previous block are effective. M and second auxiliary functions are treated in the same way as F, S, and T functions.
- 2 When a constant surface speed control is enabled (bit 0 (SSC) of parameter No. 8133 is set to 1), G96 or G97 command specified in the move command between points A and B are ineffective, and that specified in G72 block or the previous block is effective.

**- Escaping amount (e)**

The escaping amount (e) is set in parameter No. 5133.

| No.  | Unit  | Diameter/radius programming | Sign         |
|------|---|-----------------------------|--------------|
| 5133 | Depends on the increment system for the reference axis. | Radius programming          | Not required |

**- Target figure Patterns**

The following four cutting patterns are considered. All of these cutting cycles cut the workpiece with moving the tool in parallel to the second axis on the plane (X-axis for the ZX plane). At this time, the signs of the finishing allowances of  $\Delta u$  and  $\Delta w$  are as follows:

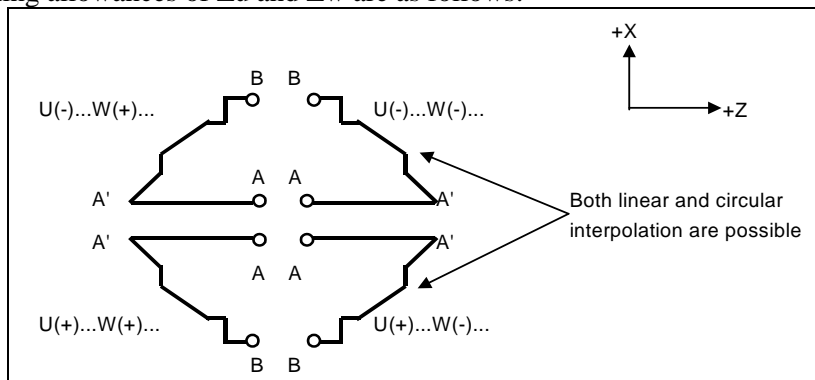

**Fig. 6.4.2 (b) Signs of the values specified at U and W in stock removal in facing**

**Limitation**

- (1) For W(+), a figure for which a position higher than the cycle start point is specified cannot be machined.  
For W(-), a figure for which a position lower than the cycle start point is specified cannot be machined.
- (2) For type I, the figure must show monotone increase or decrease along the first and second axes on the plane.
- (3) For type II, the figure must show monotone increase or decrease along the second axis on the plane.

**Start block**

In the start block in the program for a target figure (block with sequence number ns in which the path between A and A' is specified), G00 or G01 must be specified. If it is not specified, alarm PS0065, "G00/G01 IS NOT IN THE FIRST BLOCK OF SHAPE PROGRAM" is issued.

When G00 is specified, positioning is performed along A-A'. When G01 is specified, linear interpolation is performed with cutting feed along A-A'.

In this start block, also select type I or II.

If Z-axis does not move at start block, alarm PS0325 "UNAVAILABLE COMMAND IS IN SHAPE PROGRAM" is issued.

**Check functions**

During cycle operation, whether the target figure shows monotone increase or decrease is always checked.

**NOTE**

When tool nose radius compensation is applied, the target figure to which compensation is applied is checked.

The following checks can also be made.

| Check  | Related parameter   |
|--|---|
| Checks that a block with the sequence number specified at address Q is contained in the program before cycle operation.                      | Enabled when bit 2 (QSR) of parameter No. 5102 is set to 1. |
| Checks the target figure before cycle operation.<br>(Also checks that a block with the sequence number specified at address Q is contained.) | Enabled when bit 2 (FCK) of parameter No. 5104 is set to 1. |

### - Types I and II Selection of type I or II

For G72, there are types I and II.

When the target figure has pockets, be sure to use type II.

Escaping operation after rough cutting in the direction of the second axis on the plane (X-axis for the ZX plane) differs between types I and II. With type I, the tool escapes to the direction of 45 degrees. With type II, the tool cuts the workpiece along the target figure. When the target figure has no pockets, determine the desired escaping operation and select type I or II.

### Selecting type I or II

In the start block for the target figure (sequence number ns), select type I or II.

- (1) When type I is selected  
Specify the first axis on the plane (Z-axis for the ZX plane). Do not specify the second axis on the plane (X-axis for the ZX plane).
- (2) When type II is selected  
Specify the second axis on the plane (X-axis for the ZX plane) and first axis on the plane (Z-axis for the ZX plane).  
When you want to use type II without moving the tool along the second axis on the plane (X-axis for the ZX plane), specify the incremental programming with travel distance 0 (U0 for the ZX plane).

### - Type I

G72 differs from G71 in the following points:

- (1) G72 cuts the workpiece with moving the tool in parallel with the second axis on the plane (X-axis on the ZX plane).
- (2) In the start block in the program for a target figure (block with sequence number ns), only the first axis on the plane (Z-axis (W-axis) for the ZX plane) must be specified.

### - Type II

G72 differs from G71 in the following points:

- (1) G72 cuts the workpiece with moving the tool in parallel with the second axis on the plane (X-axis on the ZX plane).
- (2) The figure need not show monotone increase or decrease in the direction of the first axis on the plane (Z-axis for the ZX plane) and it may have concaves (pockets). The figure must show monotone change in the direction of the second axis on the plane (X-axis for the ZX plane), however.
- (3) When a position parallel to the second axis on the plane (X-axis for the ZX plane) is specified in a block in the program for the target figure, it is assumed to be at the bottom of a pocket.
- (4) After all rough cutting terminates along the second axis on the plane (X-axis for the ZX plane), the tool temporarily returns to the start point. Then, rough cutting as finishing is performed.

### - Tool nose radius compensation

See the pages on which G71 is explained.

### - Reducing the cycle time

See the pages on which G71 is explained.

### 6.4.3 Pattern Repeating (G73)

This function permits cutting a fixed pattern repeatedly, with a pattern being displaced bit by bit. By this cutting cycle, it is possible to efficiently cut workpiece whose rough shape has already been made by a rough machining, forging or casting method, etc.

#### Format

ZpXp plane

**G73 P(ns) Q(nf) U(Du) W(Dw) I(Di) K(Dk) D(d) F(f) S(s) T(t) ;**

**N (ns) ;** }

...

**N (nf) ;** }

The move command between A and B is specified in the blocks from sequence number ns to nf.

YpZp plane

**G73 P(ns) Q(nf) V( $\Delta w$ ) W( $\Delta u$ ) J( $\Delta k$ ) K( $\Delta i$ ) D(d) F(f) S(s) T(t) ;**

**N (ns) ;**

...

**N (nf) ;**

XpYp plane

**G73 P(ns) Q(nf) U( $\Delta w$ ) V( $\Delta u$ ) I( $\Delta k$ ) J( $\Delta i$ ) D(d) F(f) S(s) T(t) ;**

**N (ns) ;**

...

**N (nf) ;**

$\Delta i$  : Distance of escape in the direction of the second axis on the plane (X-axis for the ZX plane)

$\Delta k$  : Distance of escape in the direction of the first axis on the plane (Z-axis for the ZX plane)

d : The number of division

This value is the same as the repetitive count for rough cutting.

ns : Sequence number of the first block for the program of finishing shape.

nf : Sequence number of the last block for the program of finishing shape.

$\Delta u$  : Distance of the finishing allowance in the direction of the second axis on the plane (X-axis for the ZX plane)

$\Delta w$  : Distance of the finishing allowance in the direction of the first axis on the plane (Z-axis for the ZX plane)

f, s, t : Any F, S, and T function contained in the blocks between sequence number "ns" and "nf" are ignored, and the F, S, and T functions in this G73 block are effective.

#### NOTE

Even if pocket calculator type decimal point programming is specified (bit 0 (DPI) of parameter No. 3401 = 1), the unit of address D is the least input increment. In addition, when a decimal point is input in address D, alarm PS0007 is issued.

|            | Unit  | Diameter/radius programming  | Sign     | Decimal point input |
|------------|---|--|----------|---------------------|
| $\Delta i$ | Depends on the increment system for the reference axis. | Radius programming   | Required | Allowed             |
| $\Delta k$ | Depends on the increment system for the reference axis. | Radius programming   | Required | Allowed             |
| $\Delta u$ | Depends on the increment system for the reference axis. | Depends on diameter/radius programming for the second axis on the plane. | Required | Allowed             |
| $\Delta w$ | Depends on the increment system for the reference axis. | Depends on diameter/radius programming for the first axis on the plane.  | Required | Allowed             |

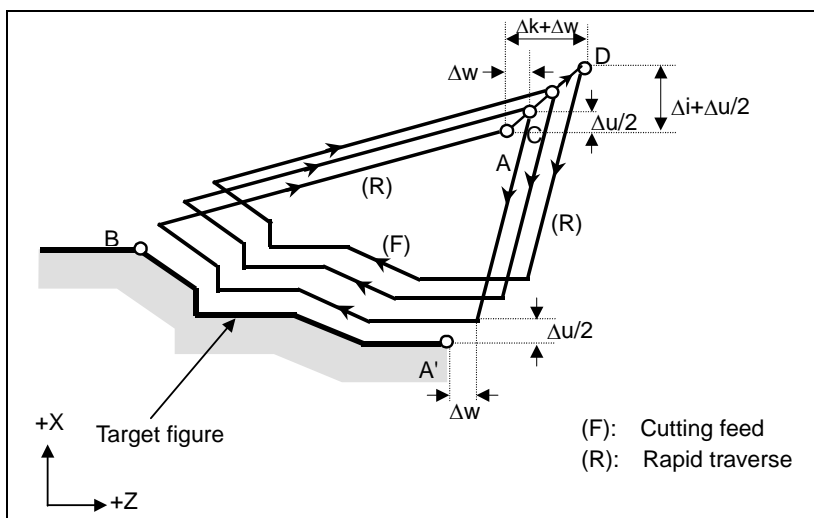

Fig. 6.4.3 (c) Cutting path in pattern repeating

## Explanation

### - Operations

When a target figure passing through A, A', and B in this order is given by a program, rough cutting is performed the specified number of times, with the finishing allowance specified by  $\Delta u/2$  and  $\Delta w$  left.

### NOTE

- 1 After cycle operation terminates, the tool returns to point A.
- 2 F, S, and T functions which are specified in the move command between points A and B are ineffective and those specified in G73 block or the previous block are effective. M and second auxiliary functions are treated in the same way as F, S, and T functions.

### - Target figure Patterns

As in the case of G71, there are four target figure patterns. Be careful about signs of  $\Delta u$ ,  $\Delta w$ ,  $\Delta i$ , and  $\Delta k$  when programming this cycle.

### Start block

In the start block in the program for the target figure (block with sequence number  $n_s$  in which the path between A and A' is specified), G00 or G01 must be specified. If it is not specified, alarm PS0065 is issued.

When G00 is specified, positioning is performed along A-A'. When G01 is specified, linear interpolation is performed with cutting feed along A-A'.

**Check function**

The following check can be made.

| <b>Check</b>  | <b>Related parameter</b>                                    |
|---|---|
| Checks that a block with the sequence number specified at address Q is contained in the program before cycle operation. | Enabled when bit 2 (QSR) of parameter No. 5102 is set to 1. |

**- Tool nose radius compensation**

Like G71, this cycle operation is performed according to the figure determined by the tool nose radius compensation path when the offset vector is 0 at start point A and start-up is performed in a block between path A-A'.



## 6.4.4 Finishing Cycle (G70)

After rough cutting by G71, G72 or G73, the following command permits finishing.

### Format

**G70 P(ns) Q(nf) ;**

ns : Sequence number of the first block for the program of finishing shape.

nf : Sequence number of the last block for the program of finishing shape.

### Explanation

#### - Operations

The blocks with sequence numbers ns to nf in the program for a target figure are executed for finishing. The F, S, T, M, and second auxiliary functions specified in the G71, G72, or G73 block are ignored and the F, S, T, M, and second auxiliary functions specified in the blocks with sequence numbers ns to nf are effective.

When cycle operation terminates, the tool is returned to the start point in rapid traverse and the next G70 cycle block is read.

#### - Target figure

##### Check function

The following check can be made.

| Check   | Related parameter   |
|---|---|
| Checks that a block with the sequence number specified at address Q is contained in the program before cycle operation. | Enabled when bit 2 (QSR) of parameter No. 5102 is set to 1. |

#### - Storing P and Q blocks

When rough cutting is executed by G71, G72, or G73, up to three memory addresses of P and Q blocks are stored. By this, the blocks indicated by P and Q are immediately found at execution of G70 without searching memory from the beginning for them. After some G71, G72, and G73 rough cutting cycles are executed, finishing cycles can be performed by G70 at a time. At this time, for the fourth and subsequent rough cutting cycles, the cycle time is longer because memory is searched for P and Q blocks.

### Example

G71 P100 Q200 ...;

N100 ...;

...;

...;

N200 ...;

G71 P300 Q400 ...;

N300 ...;

...;

...;

N400 ...;

...;

...;

G70 P100 Q200 ; (Executed without a search for the first to third cycles)

G70 P300 Q400 ; (Executed after a search for the fourth and subsequent cycles)

**NOTE**

The memory addresses of P and Q blocks stored during rough cutting cycles by G71, G72, and G73 are erased after execution of G70.

All stored memory addresses of P and Q blocks are also erased by a reset.

**- Return to the cycle start point**

In a finishing cycle, after the tool cuts the workpiece to the end point of the target figure, it returns to the cycle start point in rapid traverse.

**NOTE**

The tool returns to the cycle start point always in the nonlinear positioning mode regardless of the setting of bit 1 (LRP) of parameter No. 1401.

Before executing a finishing cycle for a target figure with a pocket cut by G71 or G72, check that the tool does not interfere with the workpiece when returning from the end point of the target figure to the cycle start point.

**- Tool nose radius compensation**

When using tool nose radius compensation, specify a tool nose radius compensation command (G41 or G42) before a multiple repetitive canned cycle command (G70) and specify the cancel command (G40) after the multiple repetitive canned cycle command (G70).

Program example

G42;.....Specify this command before a multiple repetitive canned cycle command.

G70P10Q20;

G40;.....Specify this command after a multiple repetitive canned cycle command.

Like G71, this cycle operation is performed according to the figure determined by the tool nose radius compensation path when the offset vector is 0 at start point A and start-up is performed in a block between path A-A'.

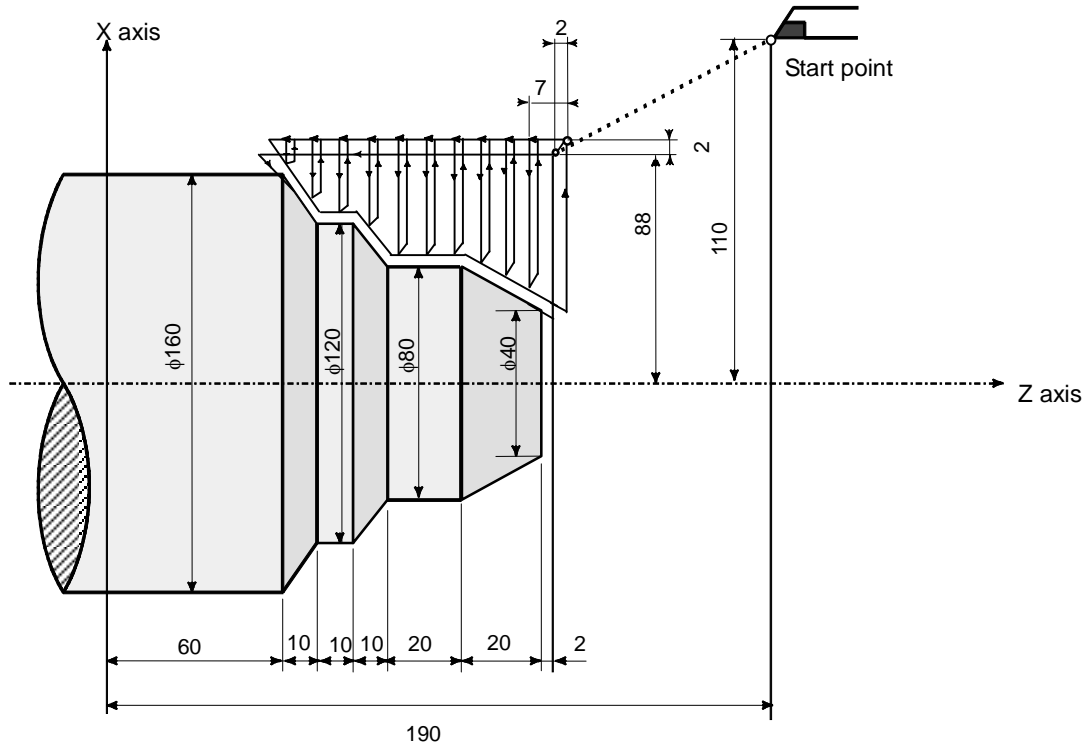
**Example****Stock removal in facing (G72)**

(Diameter designation for X axis, metric input)

```

N011 G50 X220.0 Z190.0 ;
N012 G00 X176.0 Z132.0 ;
N013 G72 P014 Q019 U4.0 W2.0 D7000 F0.3 S550 ;
N014 G00 Z56.0 S700 ;
N015 G01 X120.0 W14.0 F0.15 ;
N016 W10.0 ;
N017 X80.0 W10.0 ;
N018 W20.0 ;
N019 X36.0 W22.0 ;
N020 G70 P014 Q019 ;

```

Parameter No. 5133 = 1.0 (escaping amount)

Finishing allowance (4.0 in diameter in the X direction, 2.0 in the Z direction)

## 6. MEMORY OPERATION

USING Series 10/11 FORMAT PROGRAMMING

B-64604EN-1/01

### Pattern repeating (G73)

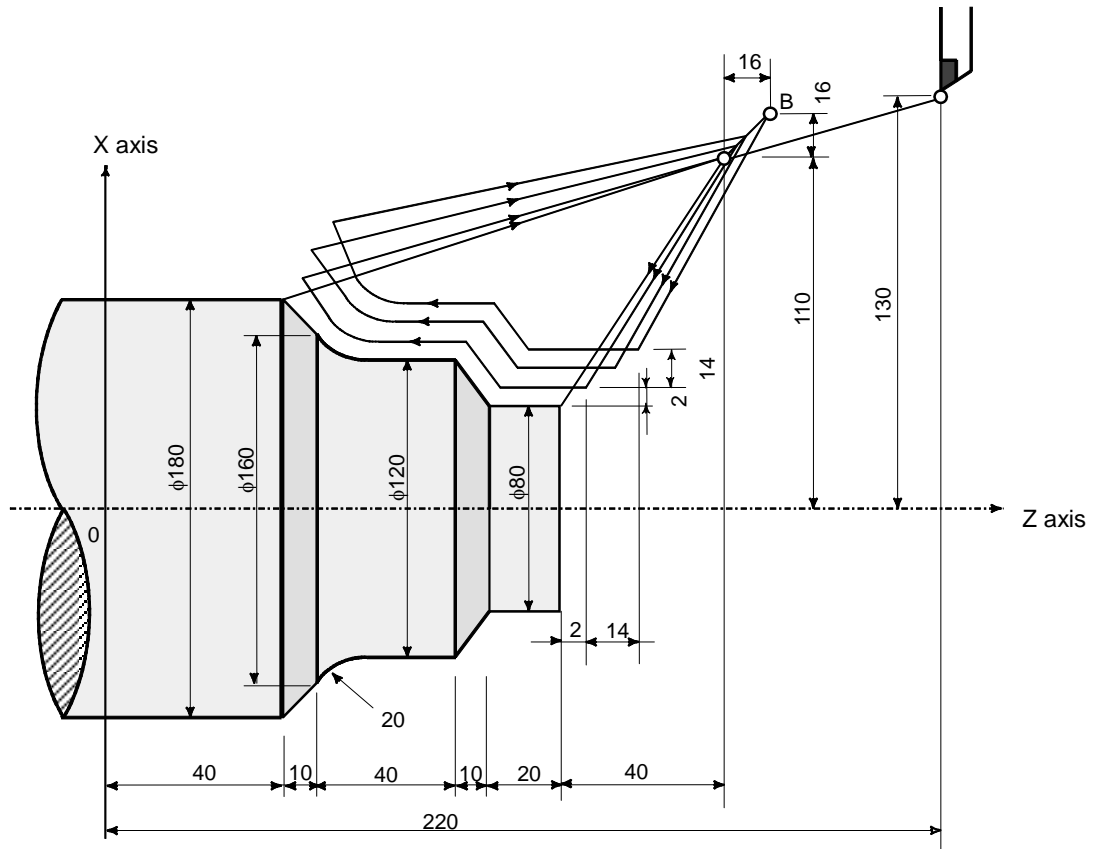

(Diameter designation, metric input)

```

N011 G50 X260.0 Z220.0 ;
N012 G00 X220.0 Z160.0 ;
N013 G73 P014 Q019 U4.0 W2.0 I14.0 K14.0 D3 F0.3 S0180
N014 G00 X80.0 W-40.0 ;
N015 G01 W-20.0 F0.15 S0600 ;
N016 X120.0 W-10.0;
N017 W-20.0 S0400 ;
N018 G02 X160.0 W-20.0 R20.0 ;
N019 G01 X180.0 W-10.0 S0280 ;
N020 G70 P014 Q019 ;
    
```

## 6.4.5 End Face Peck Drilling Cycle (G74)

This cycle enables chip breaking in outer diameter cutting. If the second axis on the plane (X-axis (U-axis) for the ZX plane) and address P are omitted, operation is performed only along the first axis on the plane (Z-axis for the ZX plane), that is, a peck drilling cycle is performed.

### Format

ZpXp-plane

**G74X(U)\_ Z(W)\_ I( $\Delta$ i) K( $\Delta$ k) D( $\Delta$ d) F(f) ;**

YpZp-plane

**G74Y(V)\_ Z(W)\_ J( $\Delta$ k) K( $\Delta$ i) D( $\Delta$ d) F(f) ;**

XpYp-plane

**G74X(U)\_ Y(V)\_ I( $\Delta$ k) J( $\Delta$ i) D( $\Delta$ d) F(f) ;**

X\_,Z\_ : Coordinate of the second axis on the plane (X-axis for the ZX plane) at point B and

Coordinate of the first axis on the plane (Z-axis for the ZX plane) at point C

U\_,W\_ : Travel distance along the second axis on the plane (U for the ZX plane) from point A to B

Travel distance along the first axis on the plane (W for the ZX plane) from point A to C

(When G code system A is used. In other cases, X\_, Z\_ is used for specification.)

$\Delta$ i : Travel distance in the direction of the second axis on the plane (X-axis for the ZX plane)

$\Delta$ k : Depth of cut in the direction of the first axis on the plane (Z-axis for the ZX plane)

$\Delta$ d : Relief amount of the tool at the cutting bottom

f : Feedrate

|            | Unit  | Diameter/radius programming | Sign         | Decimal point input |
|------------|---|-----------------------------|--------------|---------------------|
| $\Delta$ i | Depends on the increment system for the reference axis. | Radius programming          | Not required | Allowed             |
| $\Delta$ k | Depends on the increment system for the reference axis. | Radius programming          | Not required | Allowed             |
| $\Delta$ d | Depends on the increment system for the reference axis. | Radius programming          | NOTE 1       | Not allowed         |

### NOTE

- 1 Normally, specify a positive value for  $\Delta$ d. When X (U) and  $\Delta$ i are omitted, specify a value with the sign indicating the direction in which the tool is to escape.
- 2 Even if pocket calculator type decimal point programming is specified (bit 0 (DPI) of parameter No. 3401 = 1), the unit of address D is least input increment. In addition, when a decimal point is input in address D, an alarm PS0007, "ILLEGAL USE OF DECIMAL POINT" is issued.

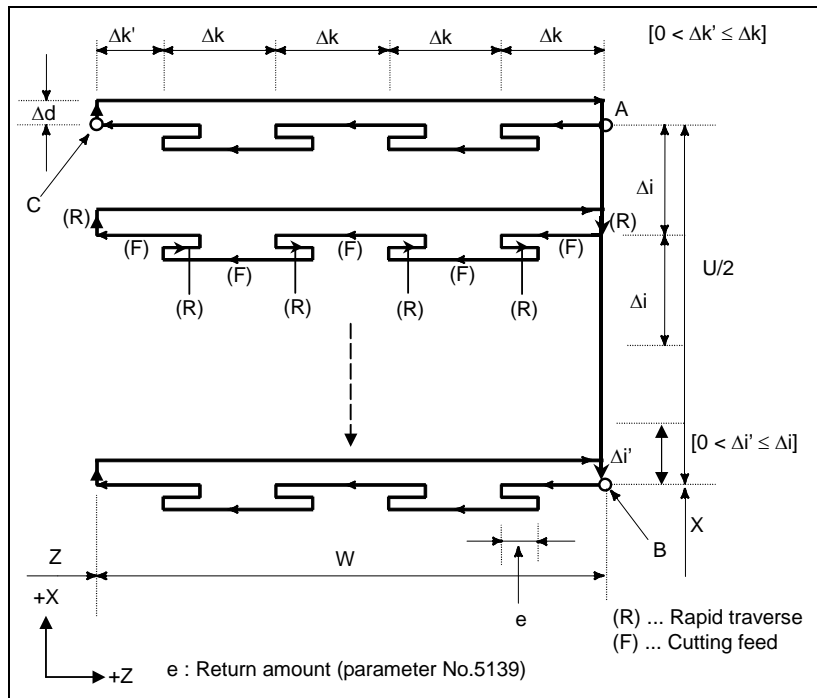

Fig. 6.4.5 (a) Cutting path in end face peek drilling cycle

**Explanation**

**- Operations**

A cycle operation of cutting by  $\Delta k$  and return by  $e$  is repeated.

When cutting reaches point C, the tool escapes by  $\Delta d$ . Then, the tool returns in rapid traverse, moves to the direction of point B by  $\Delta i$ , and performs cutting again.

**- Return amount (e)**

The return amount ( $e$ ) is set in parameter No. 5139.

| No.  | Unit  | Diameter/radius programming | Sign         |
|------|---|-----------------------------|--------------|
| 5139 | Depends on the increment system for the reference axis. | Radius programming          | Not required |

**- Tool nose radius compensation**

Tool nose radius compensation cannot be applied.

## 6.4.6 Outer Diameter / Internal Diameter Drilling Cycle (G75)

This cycle is equivalent to G74 except that the second axis on the plane (X-axis for the ZX plane) changes places with the first axis on the plane (Z-axis for the ZX plane). This cycle enables chip breaking in end facing. It also enables grooving during outer diameter cutting and cutting off (when the Z-axis (W-axis) and Q are omitted for the first axis on the plane).

### Format

ZpXp-plane

**G75 X(U)\_ Z(W)\_ I( $\Delta$ i) K( $\Delta$ k) D( $\Delta$ d) F (f) ;**

YpZp-plane

**G75 Y(V)\_ Z(W)\_ J( $\Delta$ k) K( $\Delta$ i) D( $\Delta$ d) F(f) ;**

XpYp-plane

**G75 X(U)\_ Y(V)\_ I( $\Delta$ k) J( $\Delta$ i) D( $\Delta$ d) F(f) ;**

- X\_, Z\_ : Coordinate of the second axis on the plane (X-axis for the ZX plane) at point B and  
Coordinate of the first axis on the plane (Z-axis for the ZX plane) at point C
- U\_, W\_ : Travel distance along the second axis on the plane (U for the ZX plane) from point A to B  
Travel distance along the first axis on the plane (W for the ZX plane) from point A to C
- $\Delta$ i : Depth of cut in the direction of the second axis on the plane (X-axis for the ZX plane)
- $\Delta$ k : Travel distance in the direction of the first axis on the plane (Z-axis for the ZX plane)
- $\Delta$ d : Relief amount of the tool at the cutting bottom
- f : Feedrate

|            | Unit  | Diameter/radius programming | Sign         | Decimal point input |
|------------|---|-----------------------------|--------------|---------------------|
| $\Delta$ i | Depends on the increment system for the reference axis. | Radius programming          | Not required | Allowed             |
| $\Delta$ k | Depends on the increment system for the reference axis. | Radius programming          | Not required | Allowed             |
| $\Delta$ d | Depends on the increment system for the reference axis. | Radius programming          | NOTE 1       | Not allowed         |

### NOTE

- Normally, specify a positive value for  $\Delta$ d. When Z (W) and  $\Delta$ k are omitted, specify a value with the sign indicating the direction in which the tool is to escape.
- Even if pocket calculator type decimal point programming is specified (bit 0 (DPI) of parameter No. 3401 = 1), the unit of address D is least input increment. In addition, when a decimal point is input in address D, an alarm PS0007, "ILLEGAL USE OF DECIMAL POINT" is issued.

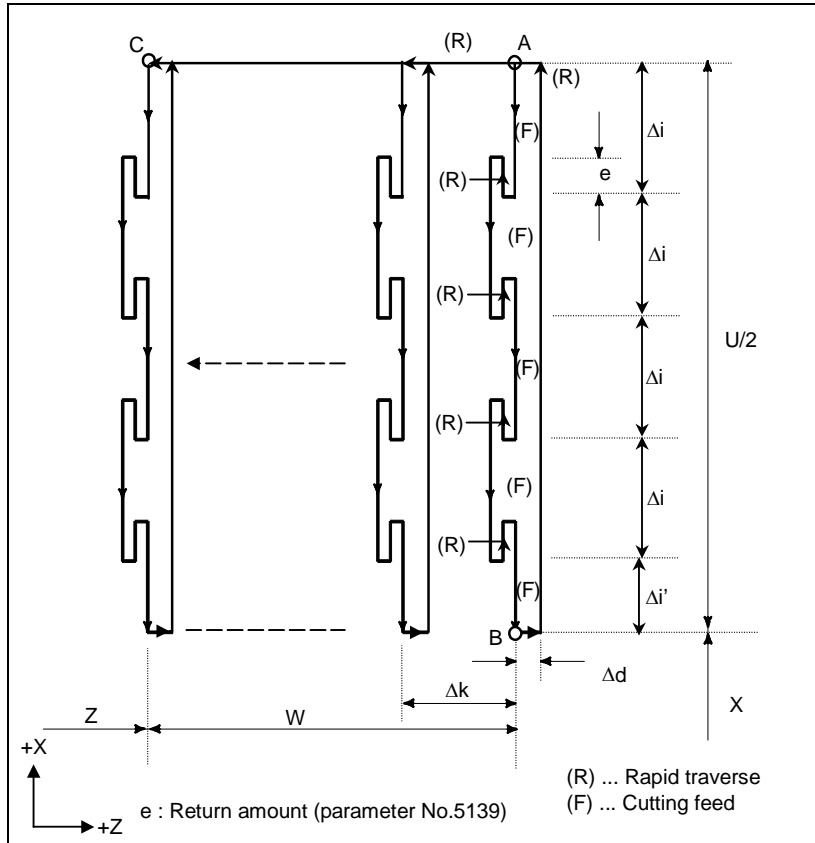

Fig. 6.4.6 (a) Outer diameter/internal diameter drilling cycle

**Explanation**

**- Operations**

A cycle operation of cutting by  $\Delta i$  and return by  $e$  is repeated.

When cutting reaches point B, the tool escapes by  $\Delta d$ . Then, the tool returns in rapid traverse, moves to the direction of point C by  $\Delta k$ , and performs cutting again.

Both G74 and G75 are used for grooving and drilling, and permit the tool to relief automatically. Four symmetrical patterns are considered, respectively.

**- Return amount (e)**

The return amount ( $e$ ) is set in parameter No. 5133.

| No.  | Unit  | Diameter/radius programming | Sign         |
|------|---|-----------------------------|--------------|
| 5139 | Depends on the increment system for the reference axis. | Radius programming          | Not required |

**- Tool nose radius compensation**

Tool nose radius compensation cannot be applied.



## 6.4.7 Multiple Threading Cycle (G76)

The multiple threading cycle can select four cutting methods.

### Format

ZpXp-plane

**G76 X(U)\_ Z(W)\_ I(i) K(k) D( $\Delta$ d) A(a) F(L) P(p) Q(q) ;**

YpZp-plane

**G76 Y(V)\_ Z(W)\_ J(k) K(i) D( $\Delta$ d) A(a) F(L) P(p) Q(q) ;**

XpYp-plane

**G76 X(U)\_ Y(V)\_ I(k) J(i) D( $\Delta$ d) A(a) F(L) P(p) Q(q) ;**

X\_, Z\_ : Coordinates of the cutting end point (point D in the figure) in the direction of the length

U\_, W\_ : Travel distance to the cutting end point (point D in the figure) in the direction of the length

a : Angle of tool nose  
From 0 to 120 in steps of 1 degree (The default is 0.)

i : Taper amount  
If i = 0, ordinary straight threading can be made.

k : Height of thread

$\Delta$ d : Depth of cut in 1st cut

L : Lead of thread

p : Cutting method (one-edge threading with constant cutting amount by default or for P0)

P1: One-edge threading with constant cutting amount

P2: Both-edge zigzag threading with constant cutting amount

P3: One-edge threading with constant depth of cut

P4: Both-edge zigzag threading with constant depth of cut

q : Threading start angle shift (From 0 to 360 degrees in steps of 0.001 degrees)

### NOTE

- 1 Even if pocket calculator type decimal point programming is specified (bit 0 (DPI) of parameter No. 3401 = 1), the unit of address D is least input increment. In addition, when a decimal point is input in address D, an alarm PS0007, "ILLEGAL USE OF DECIMAL POINT" is issued.
- 2 A decimal point included in address A has no meaning. That is, 'A120.' is equivalent to 'A120' in specifying 120 degrees.
- 3 Address Q does not allow decimal point input.

|            | Unit  | Diameter/radius programming | Sign         | Decimal point input |
|------------|---|-----------------------------|--------------|---------------------|
| i          | Depends on the increment system for the reference axis. | Radius programming          | Required     | Allowed             |
| k          | Depends on the increment system for the reference axis. | Radius programming          | Not required | Allowed             |
| $\Delta$ d | Depends on the increment system for the reference axis. | Radius programming          | Not required | Not allowed         |

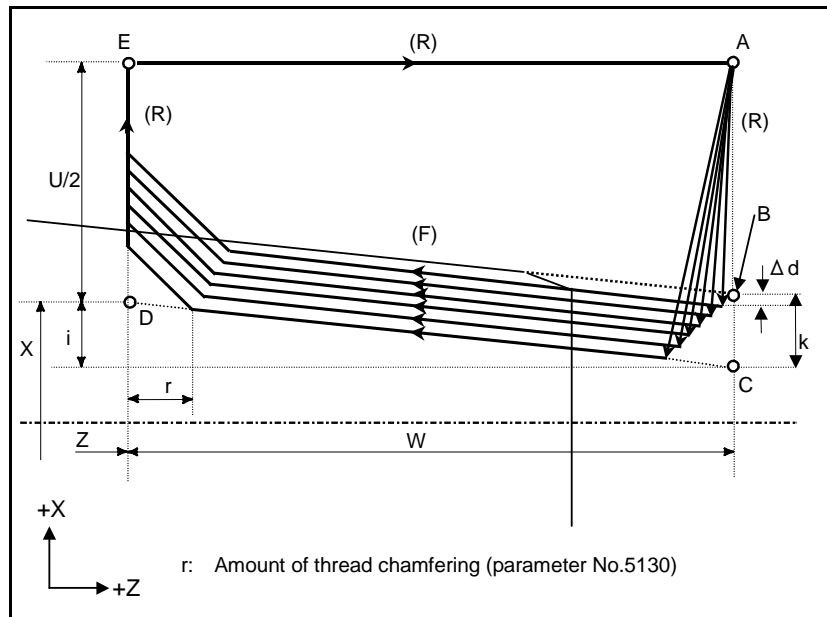

Fig. 6.4.7 (a) Cutting path in multiple threading cycle

**Explanation**

**- Operations**

This cycle performs threading so that the length of the lead only between C and D is made as specified in the F code. In other sections, the tool moves in rapid traverse.

The time constant for acceleration/deceleration after interpolation and FL feedrate for thread chamfering and the feedrate for retraction after chamfering are the same as for thread chamfering with canned cycle.

**⚠ CAUTION**

Notes on threading are the same as those on G32 threading. For feed hold in a threading cycle, however, see "Feed hold in a threading cycle" described below.

**- Cutting method**

There are four cutting methods.

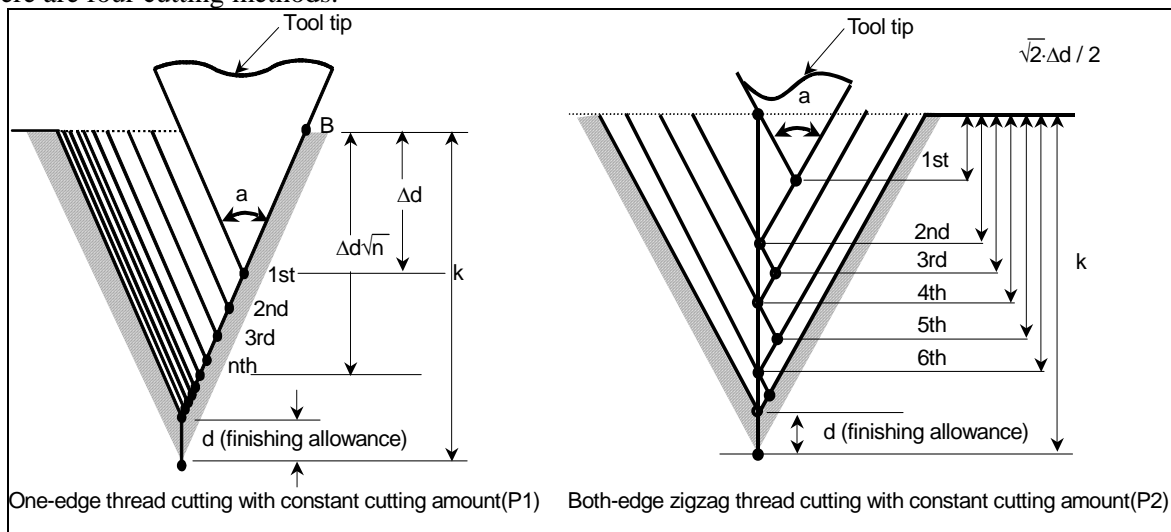
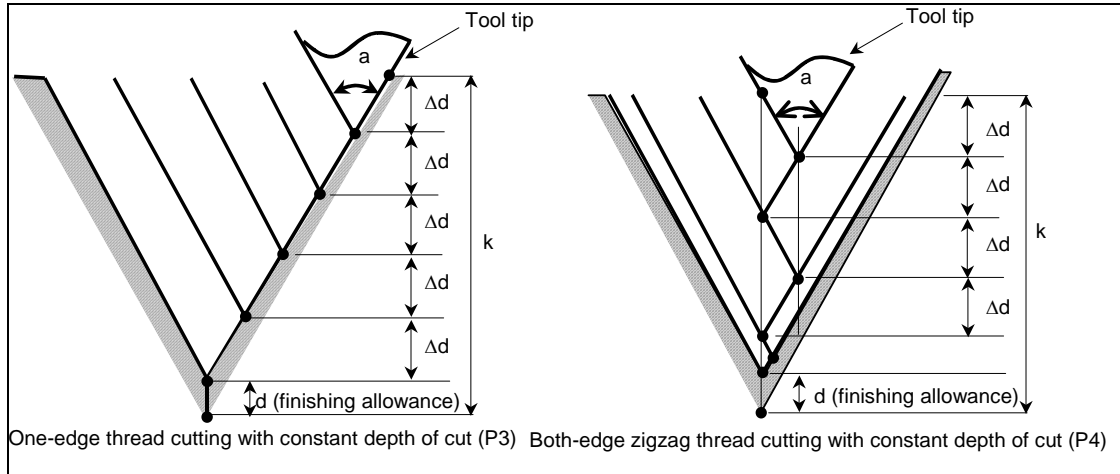

Fig. 6.4.7 (b) One-edge threading with constant cutting amount, both-edge zigzag threading with constant cutting amount (P1/2)



**Fig. 6.4.7 (c) One-edge threading with constant depth of cut, both-edge zigzag threading with constant depth of cut (P3/4)**

**- Repetitive count in finishing**

The last finishing cycle (cycle in which the finishing allowance is removed by cutting) is repeated. The repetitive count is set in parameter No. 5142. If the setting is 0, the operation is performed once.

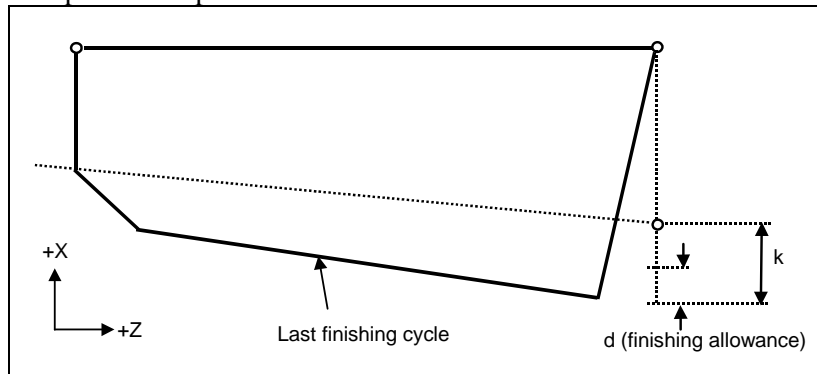

**- Minimum depth of cut**

When a cutting method with constant cutting amount is selected (P1 or P2), clamping can be performed with the minimum depth of cut to prevent the depth of cut from becoming too small. The minimum depth of cut is set in parameter No. 5140.

| No.  | Unit  | Diameter/radius programming | Sign         |
|------|---|-----------------------------|--------------|
| 5140 | Depends on the increment system for the reference axis. | Radius programming          | Not required |

**- Finishing allowance**

The finishing allowance is set in parameter No. 5141.

| No.  | Unit  | Diameter/radius programming | Sign         |
|------|---|-----------------------------|--------------|
| 5141 | Depends on the increment system for the reference axis. | Radius programming          | Not required |

**NOTE**  
Set a value smaller than the height of thread as the finishing allowance. (No. 5141 < k)

## 6. MEMORY OPERATION

USING Series 10/11 FORMAT PROGRAMMING

B-64604EN-1/01

### - Relationship between the sign of the taper amount and tool path

The signs of incremental dimensions for the cycle shown in Fig. 6.4.7 (a) are as follows:

Cutting end point in the direction of the length for U and W:

Minus (determined according to the directions of paths A-C and C-D)

Taper amount (i) : Minus (determined according to the direction of path A-C)

Height of thread (k) : Plus (always specified with a plus sign)

Depth of cut in the first cut ( $\Delta d$ ) : Plus (always specified with a plus sign)

The four patterns shown in the Table 6.4.7 (a) are considered corresponding to the sign of each address. A female thread can also be machined.

Table 6.4.7 (a)

| Outer diameter machining   | Internal diameter machining  |
|--|--|
| <p>1. <math>U &lt; 0, W &lt; 0, i &lt; 0</math></p>                                    | <p>2. <math>U &gt; 0, W &lt; 0, i &gt; 0</math></p>                                    |
| <p>3. <math>U &lt; 0, W &lt; 0, i &gt; 0</math><br/>at <math> i  \leq  U/2 </math></p> | <p>4. <math>U &gt; 0, W &lt; 0, i &lt; 0</math><br/>at <math> i  \leq  U/2 </math></p> |

### - Acceleration/deceleration after interpolation for threading

Acceleration/deceleration after interpolation for threading is acceleration/deceleration of exponential interpolation type. By setting bit 5 (THLx) of parameter No. 1610, the same acceleration/deceleration as for cutting feed can be selected. (The settings of bits 1 (CTBx) and 0 (CTLx) of parameter No. 1610 are followed.) However, as a time constant and FL feedrate, the settings of parameter No. 1626 and No. 1627 for the threading cycle are used.

### - Time constant and FL feedrate for threading

The time constant for acceleration/deceleration after interpolation for threading specified in parameter No. 1626 and the FL feedrate specified in parameter No. 1627 are used.

The FL feedrate is valid only for exponential acceleration/deceleration after interpolation.

### - Thread chamfering

Thread chamfering can be performed in this threading cycle. A signal from the machine tool initiates thread chamfering.

The maximum amount of thread chamfering (r) can be specified in a range from 0.1L to 12.7L in 0.1L increments in parameter No. 5130.

A thread chamfering angle between 1 to 89 degrees can be specified in parameter No. 5131. When a value of 0 is specified in the parameter, an angle of 45 degrees is assumed.

For thread chamfering, the same type of acceleration/deceleration after interpolation, time constant for acceleration/deceleration after interpolation, and FL feedrate as for threading are used.

**NOTE**

Common parameters for specifying the amount and angle of thread chamfering are used for this cycle and G92 threading cycle.

**- Retraction after chamfering**

The Table 6.4.7 (b) lists the feedrate, type of acceleration/deceleration after interpolation, and time constant of retraction after chamfering.

Table 6.4.7 (b)

| Bit 3 (CFR) of parameter No. 1611 | Parameter No. 1466 | Description  |
|-----------------------------------|--------------------|--|
| 0                                 | Other than 0       | Uses the type of acceleration/deceleration after interpolation for threading, time constant for threading (parameter No. 1626), FL feedrate (parameter No. 1627), and retraction feedrate specified in parameter No. 1466.   |
| 0                                 | 0                  | Uses the type of acceleration/deceleration after interpolation for threading, time constant for threading (parameter No. 1626), FL feedrate (parameter No. 1627), and rapid traverse rate specified in parameter No. 1420.   |
| 1                                 |                    | Before retraction a check is made to see that the specified feedrate has become 0 (delay in acceleration/deceleration is 0), and the type of acceleration/deceleration after interpolation for rapid traverse is used together with the rapid traverse time constant and the rapid traverse rate (parameter No. 1420). |

By setting bit 4 (ROC) of parameter No. 1403 to 1, rapid traverse override can be disabled for the feedrate of retraction after chamfering.

**NOTE**

During retraction, the machine does not stop with an override of 0% for the cutting feedrate regardless of the setting of bit 4 (RF0) of parameter No. 1401.

**- Shifting the start angle**

Address Q can be used to shift the start angle of threading.

The start angle (Q) increment is 0.001 degrees and the valid setting range is between 0 and 360 degrees. No decimal point can be specified.

**- Feed hold when the threading cycle retract function is used**

When feed hold is applied during threading in a multiple threading cycle (G76), the tool quickly retracts in the same way as for the last chamfering in a threading cycle and returns to the start point in the current cycle.

When cycle start is triggered, the multiple threading cycle resumes.

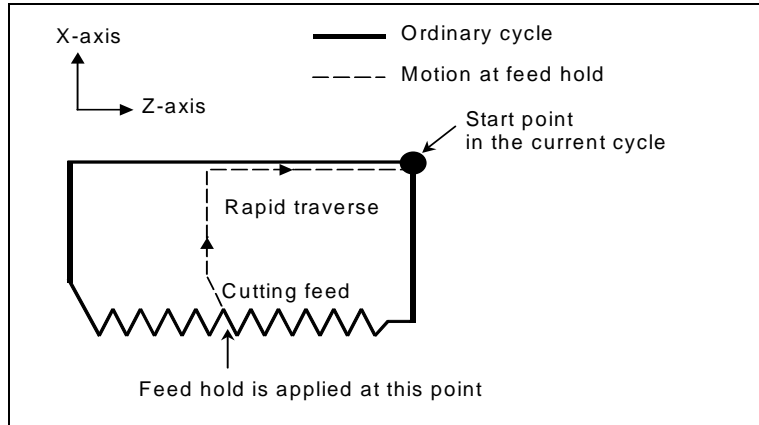

The angle of chamfering during retraction is the same as that of chamfering at the end point.

**CAUTION**  
Feed hold operation during retraction is disabled.

**- Inch threading**

Inch threading specified with address E is allowed.

**- Tool nose radius compensation**

Tool nose radius compensation cannot be applied.

**Example**

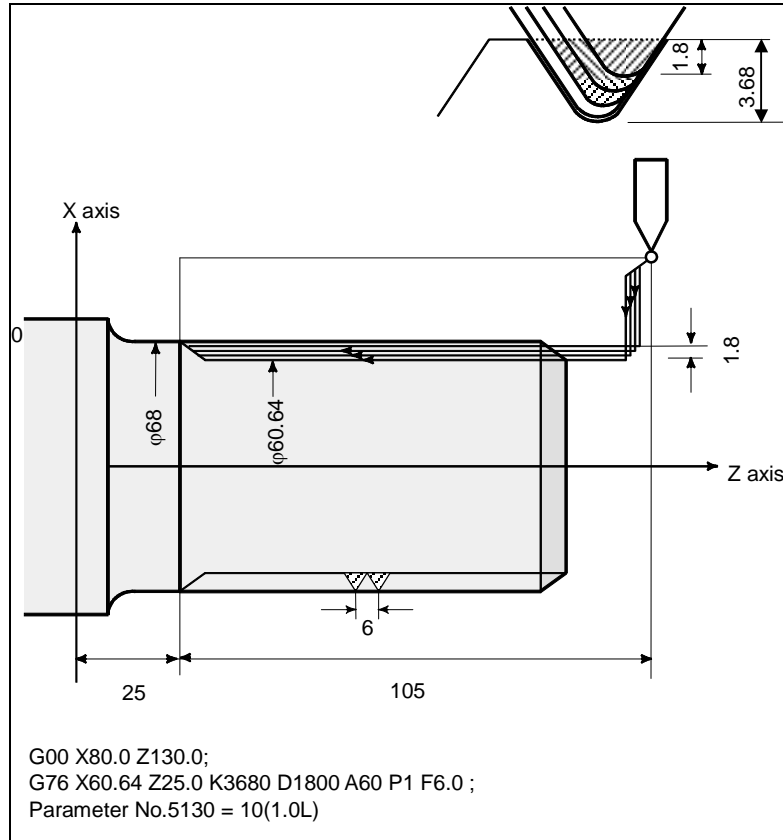

## 6.4.8 Restrictions on Multiple Repetitive Canned Cycle

---

### Programmed commands

#### - Program memory

Programs using G70, G71, G72, or G73 must be stored in the program memory. The use of the mode in which programs stored in the program memory are called for operation enables these programs to be executed in other than the MEM mode. Programs using G74, G75, or G76 need not be stored in the program memory.

#### - Blocks in which data related to a multiple repetitive canned cycle is specified

The addresses P, Q, X, Z, U, W, and R should be specified correctly for each block.

In a block in which G70, G71, G72, or G73 is specified, the following functions cannot be specified:

- Custom macro calls (simple call, modal call, and subprogram call)

#### - Blocks in which data related to a target figure is specified

In the block which is specified by address P of a G71, G72 or G73, G00 or G01 code in group 01 should be commanded. If it is not commanded, alarm PS0065, "G00/G01 IS NOT IN THE FIRST BLOCK OF SHAPE PROGRAM" is generated.

In blocks with sequence numbers between those specified at P and Q in G70, G71, G72, and G73, the following commands can be specified:

- Dwell (G04)
- G00, G01, G02, and G03  
When a circular interpolation command (G02, G03) is used, there must be no radius difference between the start point and end point of the arc. If there is a radius difference, the target finishing figure may not be recognized correctly, resulting in a cutting error such as excessive cutting.
- Custom macro branch and repeat command  
The branch destination must be between the sequence numbers specified at P and Q, however. High-speed branch specified by bits 1 and 4 of parameter No. 6000 is invalid. No custom macro call (simple, modal, or subprogram call) cannot be specified.
- Direct drawing dimension programming command and chamfering and corner R command  
Direct drawing dimension programming and chamfering and corner R require multiple blocks to be specified. The block with the last sequence number specified at Q must not be an intermediate block of these specified blocks.

When G70, G71, G72, or G73 is executed, the sequence number specified by address P and Q should not be specified twice or more in the same program.

When #1 = 2500 is executed using a custom macro, 2500.000 is assigned to #1. In such a case, P#1 is equivalent to P2500.

## Relation with other functions

### - Manual intervention

After manual intervention is performed with the manual absolute on command before the execution of a multiple repetitive canned cycles (G70 to G76) or after the stop of the execution, when a cycle operation starts, the manual intervention amount is canceled even with an incremental cycle start command. When only the first plane axis is specified in G74 or only the second plane axis is specified in G74, however, the manual intervention amount is canceled only along the specified axis.

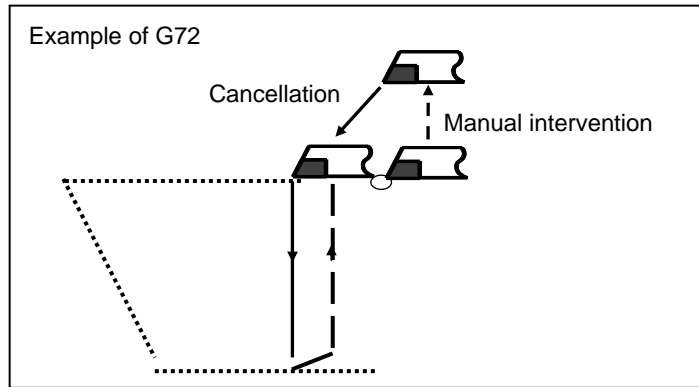

### - Interruption type macro

Any interruption type macro program cannot be executed during execution of a multiple repetitive canned cycle.

### - Program restart and tool retract and recover

These functions cannot be executed in a block in a multiple repetitive canned cycle.

### - Axis name and second auxiliary functions

Even if address U, V, W, or A is used as an axis name or second auxiliary function, data specified at address U, V, W, or A in a G71 to G73 or G76 block is assumed to be that for the multiple repetitive canned cycle.

### - Tool nose radius compensation

When using tool nose radius compensation, specify a tool nose radius compensation command (G41, G42) before a multiple repetitive canned cycle command (G70, G71, G72, G73) and specify the cancel command (G40) outside the programs (from the block specified with P to the block specified with Q) specifying a target finishing figure. If tool nose radius compensation is specified in the program specifying a target finishing figure, alarm PS0325, "UNAVAILABLE COMMAND IS IN SHAPE PROGRAM", is issued.



## 6.5 CANNED CYCLE FOR DRILLING

Canned cycles for drilling make it easier for the programmer to create programs. With a canned cycle, a frequently-used machining operation can be specified in a single block with a G function; without canned cycles, more than one block is required. In addition, the use of canned cycles can shorten the program to save memory.

Table 6.5 (a) lists canned cycles for drilling.

### NOTE

When bit 4 (NCD) of parameter No.8137 is 0, this function can be used.

Table 6.5 (a) Canned cycles for drilling

| G code | Drilling operation (-Z direction) | Operation in the bottom hole position | Retraction operation (-Z direction) | Applications                   |
|--------|-----------------------------------|---------------------------------------|-------------------------------------|--------------------------------|
| G80    | -----                             | -----                                 | -----                               | Canceling                      |
| G81    | Cutting feed                      | -----                                 | Rapid traverse                      | Drilling, Spot drilling        |
| G82    | Cutting feed                      | Dwell                                 | Rapid traverse                      | Drilling, Counter boring       |
| G83    | Cutting feed/intermittent         | -----                                 | Rapid traverse                      | Peck drilling cycle            |
| G83.1  | Cutting feed/ intermittent        | -----                                 | Rapid traverse                      | High-speed peck drilling cycle |
| G84    | Cutting feed                      | Dwell →<br>Spindle CCW                | Cutting feed                        | Tapping                        |
| G84.2  | Cutting feed                      | Dwell →<br>Spindle CCW                | Cutting feed                        | Rigid tapping                  |
| G85    | Cutting feed                      | -----                                 | Cutting feed                        | Boring                         |
| G89    | Cutting feed                      | Dwell                                 | Cutting feed                        | Boring                         |

### Explanation

The canned cycle for drilling consists of the following six operation sequences.

- Operation 1 Positioning of X and Z axis (Another axis may be targeted.)
- Operation 2 Rapid traverse up to point R level
- Operation 3 Hole machining
- Operation 4 Operation at the bottom of a hole
- Operation 5 Retraction to point R level
- Operation 6 Rapid traverse up to the initial level

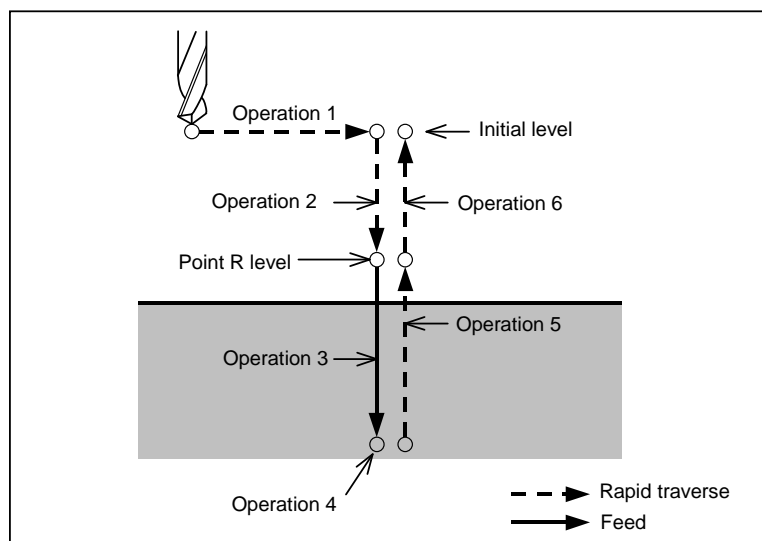

Fig. 6.5 (a) Operation sequence of canned cycle for drilling

### - Positioning plane

A positioning plane is determined by plane selection with G17, G18, and G19.

The axes other than the drilling axis are used as positioning axes.

### - Drilling axis

Although canned cycles include tapping and boring cycles as well as drilling cycles, in this chapter, only the term drilling will be used to refer to operations implemented with canned cycles.

The basic axis (X, Y, or Z) that does not exist on the positioning plane or its parallel axis is used as the drilling axis.

The axis address of the drilling axis specified in the same block as the G codes (G81 to G89) determines whether a basic axis or one of parallel axes is used as the drilling axis.

If the axis address of the drilling axis is not specified, the basic axis is used as the drilling axis.

**Table 6.5 (b) Positioning plane and drilling axis**

| G code | Positioning plane | Drilling axis |
|--------|-------------------|---------------|
| G17    | Xp-Yp-plane       | Zp            |
| G18    | Zp-Xp-plane       | Yp            |
| G19    | Yp-Zp-plane       | Xp            |

Xp : X axis or its parallel axis

Yp : Y axis or its parallel axis

Zp : Z axis or its parallel axis

### - Example

Suppose parameter No. 1022 is set so that U, V, and W are the parallel axes of X, Y, and Z, respectively.

G17 G81 Z \_\_: Drilling axis is Z axis.

G17 G81 W \_\_: Drilling axis is W axis.

G18 G81 Y \_\_: Drilling axis is Y axis.

G18 G81 V \_\_: Drilling axis is V axis.

G19 G81 X \_\_: Drilling axis is X axis.

G19 G81 U \_\_: Drilling axis is U axis.

G17, G18, and G19 may be specified in a block in which G73 to G89 are not present.

### CAUTION

Before switching between drilling axes, cancel canned cycles.

### NOTE

The Z-axis can always be used as the drilling axis by setting FXY (bit 0 of parameter No.5101). When FXY is 0, the Z-axis is always used as the drilling axis.

### - Specification of point R

In the Series 0i command format, the distance from the initial level to point R is specified using an incremental value during specification of point R.

In the Series 10/11 command format, the specification method depends on bit 6 (RAB) of parameter No. 5102. When RAB = 0, an incremental value is always used for specification. When RAB = 1 for G code system A, an absolute value is used for specification. When RAB = 1 for G code system B, C, an absolute value is used in G90 mode while an incremental value is used in G91 mode.

| Series 10/11 command format           |                   |             | Series 0i command format |             |
|---------------------------------------|-------------------|-------------|--------------------------|-------------|
| Bit 6 (RAB) of parameter No. 5102 = 1 |                   | RAB=0       |                          | Incremental |
| G code system A                       | G code system B,C |             | Incremental              |             |
| Absolute                              | G90               | G91         |                          |             |
|                                       | Absolute          | Incremental |                          |             |

### - Diameter/radius programming

The diameter/radius specification of canned cycles for drilling R command in the series 10/11 command format can be matched with the diameter/radius specification of the drilling axis by setting bit 7 (RDI) of parameter No. 5102 to 1.

### - P

In the following G codes, dwell operation differs between Series 10/11.

Operation of the Series 10/11 format

In G83, G83.1, G84, and G84.2, dwelling is performed only when address P is specified in a block.

Operation of Series 10/11

In G83 and G83.1, dwelling is not performed.

In G84 and G84.2, dwelling with address P can be performed by setting bit 1 (DWL) of parameter No. 6200. Address P is modal data.

### - Q

Address Q is always specified by using an incremental value during specification of a radius.

### - Feedrate for G85 and G89

In G85 and G89, the feedrate from point Z to point R is double the cutting feedrate. For Series 10/11, it is the same as the cutting feedrate.

### - Drilling mode

G81 to G89 are modal G codes and remain in effect until canceled. When in effect, the current state is the drilling mode.

Once drilling data is specified in the drilling mode, the data is retained until modified or canceled.

Specify all necessary drilling data at the beginning of canned cycles; when canned cycles are being performed, specify data modifications only.

### - Return point level G98/G99

In G code system A, the tool returns to the initial level from the bottom of a hole. In G code system B or C, specifying G98 returns the tool to the initial level from the bottom of a hole and specifying G99 returns the tool to the point-R level from the bottom of a hole.

The following illustrates how the tool moves when G98 or G99 is specified. Generally, G99 is used for the first drilling operation and G98 is used for the last drilling operation.

The initial level does not change even when drilling is performed in the G99 mode.

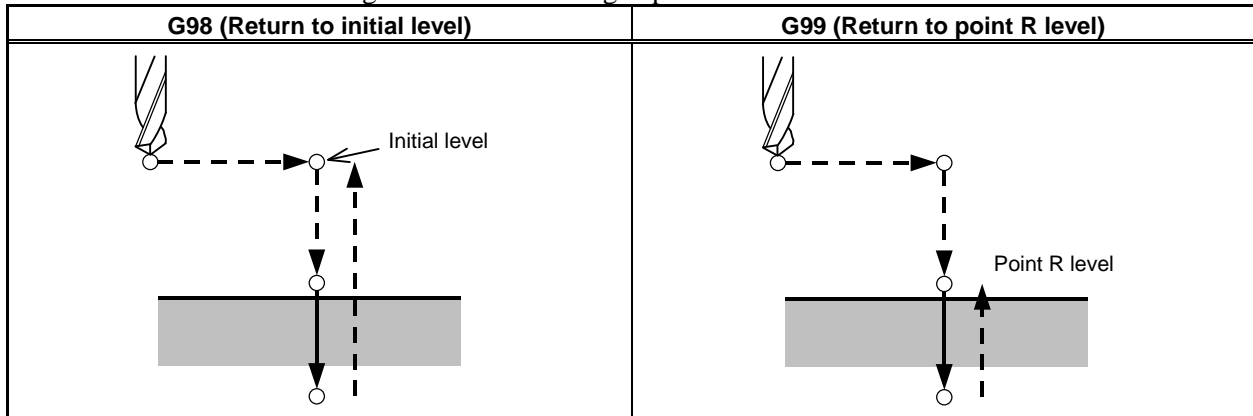

Fig. 6.5 (b) Initial level and point R level

### - Number of repeats

To repeat drilling for equally-spaced holes, specify the number of repeats in L\_.

L is effective only within the block where it is specified.

## 6. MEMORY OPERATION

Specify the first hole position in incremental mode.  
If it is specified in absolute mode, drilling is repeated at the same position.

|                     |                                  |
|---------------------|----------------------------------|
| Number of repeats L | The maximum command value = 9999 |
|---------------------|----------------------------------|

When L0 is specified, drilling data is just stored without drilling being performed.

### NOTE

For L, specify an integer of 0 or 1 to 9999.

#### - C axis clamp

The M code for C axis clamp can be specified in the Series 0i command format, but it cannot be specified in the Series 10/11 command format.

#### - Disabling the Series 10/11 format

The Series 10/11 command format can be disabled only during a canned cycle for drilling by setting bit 3 (F16) of parameter No. 5102 to 1. However, the repetitive count must be specified by address L.

### ⚠ CAUTION

If bit 3 (F16) of parameter No. 5102 is set to 1, the settings of bits 6 (RAB) and 7 (RDI) of parameter No. 5102 are disabled, and operation when RAB=0 and RDI=0 is performed.

#### - Cancel



To cancel a canned cycle, use G80 or a group 01 G code.

#### Group 01 G codes (Example)

G00 : Positioning (rapid traverse)  
G01 : Linear interpolation  
G02 : Circular interpolation (CW) or helical interpolation (CW)  
G03 : Circular interpolation (CCW) or helical interpolation (CCW)

#### - Symbols in figures

Subsequent subsections explain the individual canned cycles. Figures in these explanations use the following symbols:

|   |   |
|---|---|
|  | Positioning (rapid traverse G00)        |
|  | Cutting feed (linear interpolation G01) |
| P   | Dwell                                   |

## 6.5.1 High-speed Peck Drilling Cycle (G83.1)

This cycle performs high-speed peck drilling. It performs cutting feed intermittently while discharging chips.

### Format

**G83.1 X\_ Y\_ Z\_ R\_ P\_ Q\_ F\_ L\_ ;**

X\_ Y\_ : Hole position data  
 Z\_ : The distance from point R to the bottom of the hole  
 R\_ : The distance from the initial level to point R level  
 P\_ : Dwell time  
 Q\_ : Depth of cut for each cutting feed  
 F\_ : Cutting feedrate  
 L\_ : Number of repeats (When it is needed)

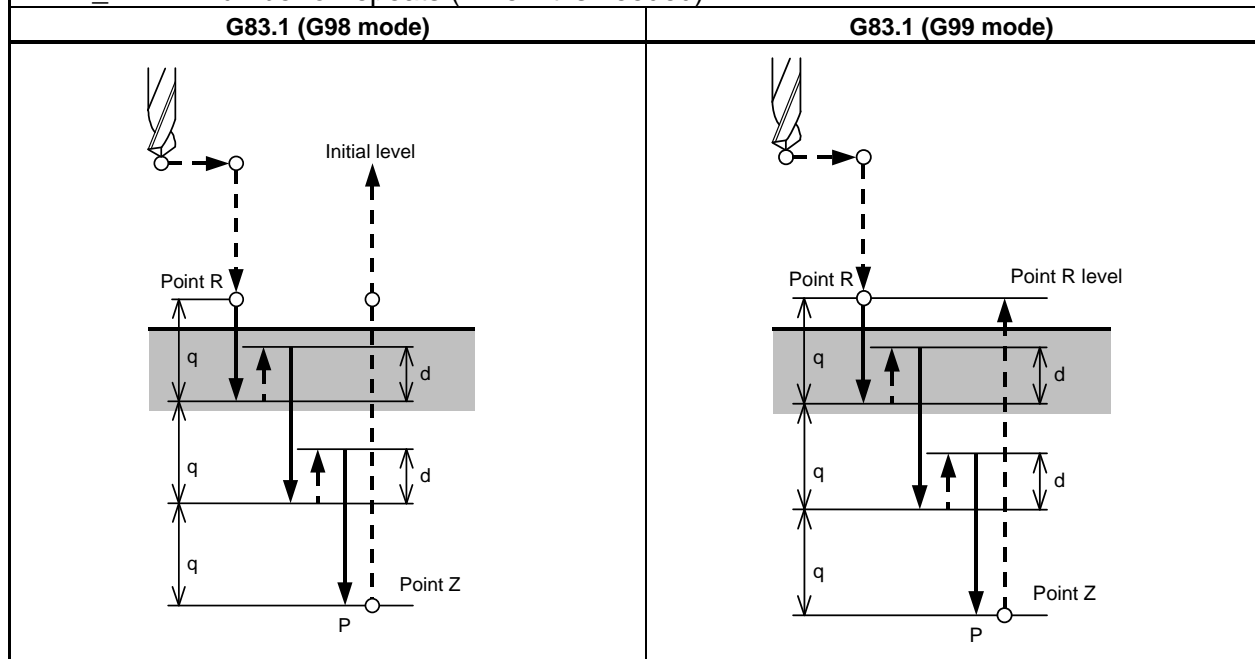

### Explanation

#### - Operations

Since intermittent feed in the Z-axis direction makes discharge of chips easier and allows the fine setting of the escaping amount, efficient machining can be performed.

Escape amount d is set in parameter No. 5114.

Escaping moves in rapid traverse.

#### - Spindle rotation

Before specifying G83.1, use an auxiliary function (M code) to rotate the spindle.

#### - Auxiliary function

If the G83.1 command and an M code are specified in the same block, the M code is executed at the first positioning. When repetitive count L is specified, the operation above is performed for the first time and the M code is not performed second and later times.

### Limitation

#### - Axis switching

Before switching between drilling axes, cancel canned cycles for drilling.

### - Drilling

In a block that does not include X, Y, Z, R, or an additional axis, drilling is not performed.

### - P

Dwelling is performed only when address P is specified in a block.

### - Q

Q must be specified in a block in which drilling is instructed. Otherwise, data is not stored as modal data.

### - Cancel

The G codes (G00 to G03) in group 01 must not be specified in the block in which G83.1 is specified. This cancels G83.1.

## 6.5.2 Drilling Cycle, Spot Drilling Cycle (G81)

The normal drilling cycle is used. The tool is then retracted from the bottom of the hole in rapid traverse.

### Format

**G81 X\_ Y\_ Z\_ R\_ F\_ L\_ ;**

X\_ Y\_ : Hole position data

Z\_ : The distance from point R to the bottom of the hole

R\_ : The distance from the initial level to point R level

F\_ : Cutting feedrate

L\_ : Number of repeats (When it is needed.)

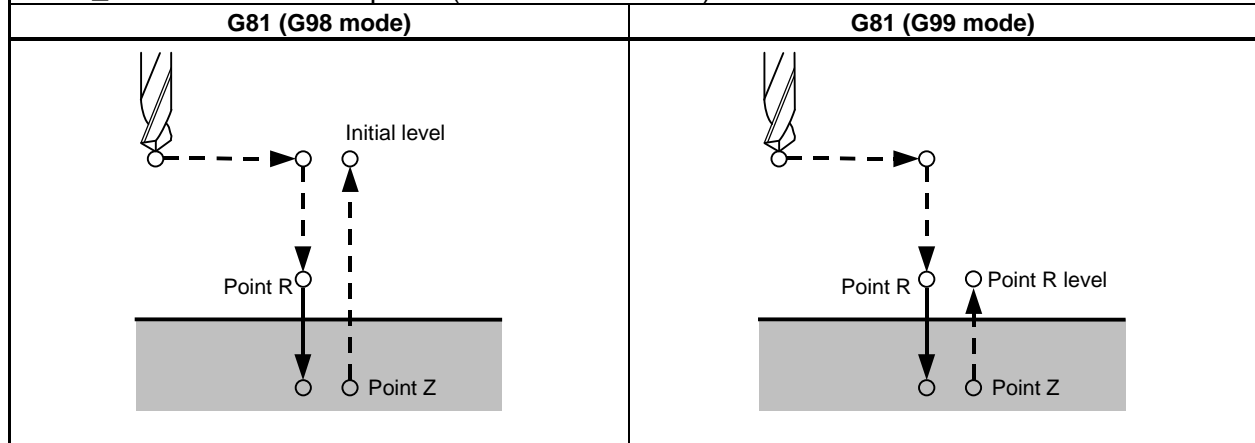

### Explanation

#### - Operations

Rapid traverse to the point R level is performed after positioning of the X- and Y- axes.

Then, drilling is performed from point R level to point Z.

Escaping moves in rapid traverse.

#### - Spindle rotation

Before specifying G81, use an auxiliary function (M code) to rotate the spindle.

#### - Auxiliary function

If the G81 command and an M code are specified in the same block, the M code is executed at the first positioning. When repetitive count L is specified, the operation above is performed for the first time and the M code is not performed second and later times.

**Limitation****- Axis switching**

Before switching between drilling axes, cancel canned cycles for drilling.

**- Drilling**

In a block that does not include X, Y, Z, R, or an additional axis, drilling is not performed.

**- Cancel**

The G codes (G00 to G03) in group 01 must not be specified in the block in which G81 is specified. This cancels G81.

**6.5.3 Drilling Cycle, Counter Boring (G82)**

The normal drilling cycle is used. Cutting feed is performed to the bottom of the hole, dwelling is performed at the bottom, and then escaping from the bottom is performed in rapid traverse. The accuracy of the hole depth is improved.

**Format**

**G82 X\_ Y\_ Z\_ R\_ P\_ F\_ L\_ ;**

X\_ Y\_ : Hole position data

Z\_ : The distance from point R to the bottom of the hole

R\_ : The distance from the initial level to point R level

P\_ : Dwell time at the bottom of a hole

F\_ : Cutting feedrate

L\_ : Number of repeats (When it is needed.)

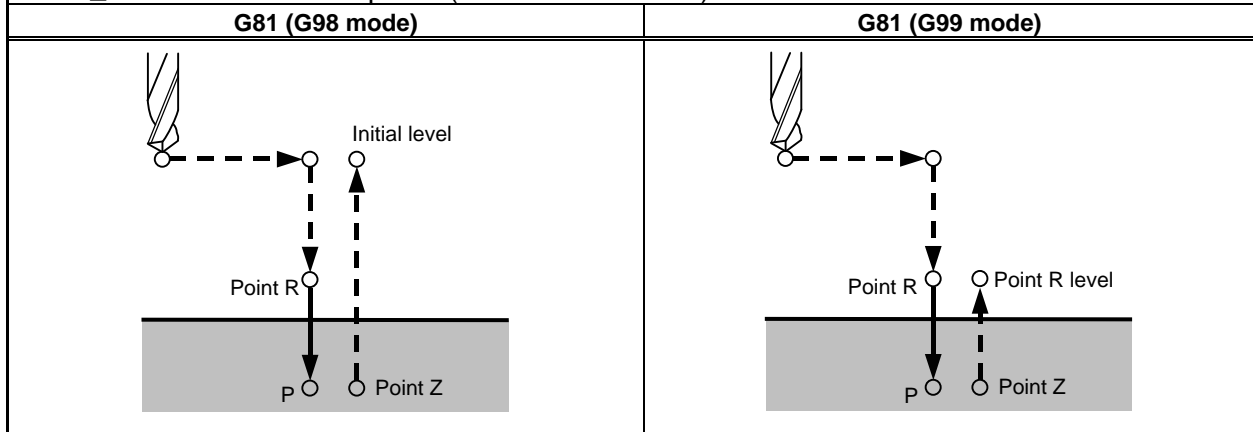
**Explanation****- Operations**

Rapid traverse to the point R level is performed after positioning of the X- and Y- axes.

Then, drilling is performed from point R level to point Z.

Dwelling is performed at the bottom of the hole and then escaping is performed in rapid traverse.

**- Spindle rotation**

Before specifying G82, use an auxiliary function (M code) to rotate the spindle.

**- Auxiliary function**

If the G82 command and an M code are specified in the same block, the M code is executed at the first positioning. When repetitive count L is specified, the operation above is performed for the first time and the M code is not performed second and later times.

**Limitation****- Axis switching**

Before switching between drilling axes, cancel canned cycles for drilling.

**- Drilling**

In a block that does not include X, Y, Z, R, or an additional axis, drilling is not performed.

**- P**

P must be specified in a block in which drilling is instructed. Otherwise, data is not stored as modal data.

**- Cancel**

The G codes (G00 to G03) in group 01 must not be specified in the block in which G82 is specified. This cancels G82.

**6.5.4 Peck Drilling Cycle (G83)**

Peck drilling is performed.

Cutting feed is performed intermittently to the bottom of the hole while chips are discharged.

**Format**

**G83 X\_ Y\_ Z\_ R\_ P\_ Q\_ F\_ L\_ ;**

X\_ Y\_ : Hole position data

Z\_ : The distance from point R to the bottom of the hole

R\_ : The distance from the initial level to point R level

P\_ : Dwell time

Q\_ : Depth of cut for each cutting feed

F\_ : Cutting feedrate

L\_ : Number of repeats (When it is needed.)

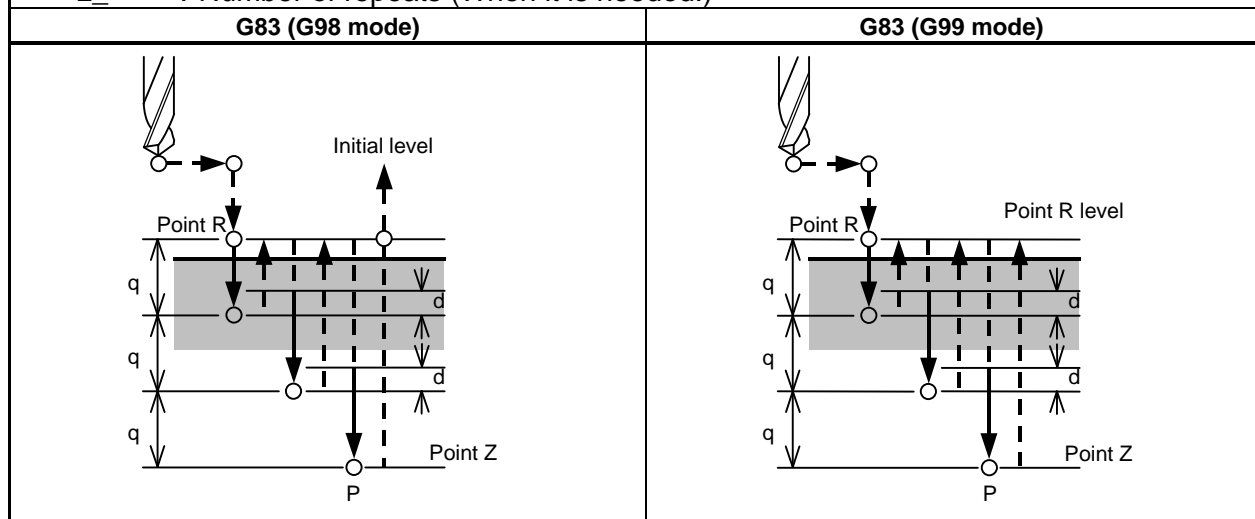
**Explanation****- Operations**

Q indicates the depth of cut for each operation and is specified by an incremental value.

In the second and later cutting operations, rapid traverse is changed to cutting feed at the point distance "d" back from the previously drilled position. "d" is set in parameter No. 5115.

A positive value must be specified for Q. A negative value is ignored.



- **Spindle rotation**

Before specifying G83, use an auxiliary function (M code) to rotate the spindle.

- **Auxiliary function**

If the G83 command and an M code are specified in the same block, the M code is executed at the first positioning. When repetitive count L is specified, the operation above is performed for the first time and the M code is not performed second and later times.

---

## Limitation

- **Axis switching**

Before switching between drilling axes, cancel canned cycles for drilling.

- **Drilling**

In a block that does not include X, Y, Z, R, or an additional axis, drilling is not performed.

- **P**

Dwelling is performed only when address P is specified in a block.

- **Q**

Q must be specified in a block in which drilling is instructed. Otherwise, data is not stored as modal data.

- **Cancel**

The G codes (G00 to G03) in group 01 must not be specified in the block in which G83 is specified. This cancels G83.

## 6.5.5 Tapping Cycle (G84)

This cycle performs tapping.

In this tapping cycle, when the bottom of the hole has been reached, the spindle is rotated in the reverse direction.

### Format

**G84 X\_ Y\_ Z\_ R\_ P\_ F\_ L\_ ;**

X\_ Y\_ : Hole position data

Z\_ : The distance from point R to the bottom of the hole

R\_ : The distance from the initial level to point R level

P\_ : Dwell time

F\_ : Cutting feedrate

L\_ : Number of repeats (When it is needed.)

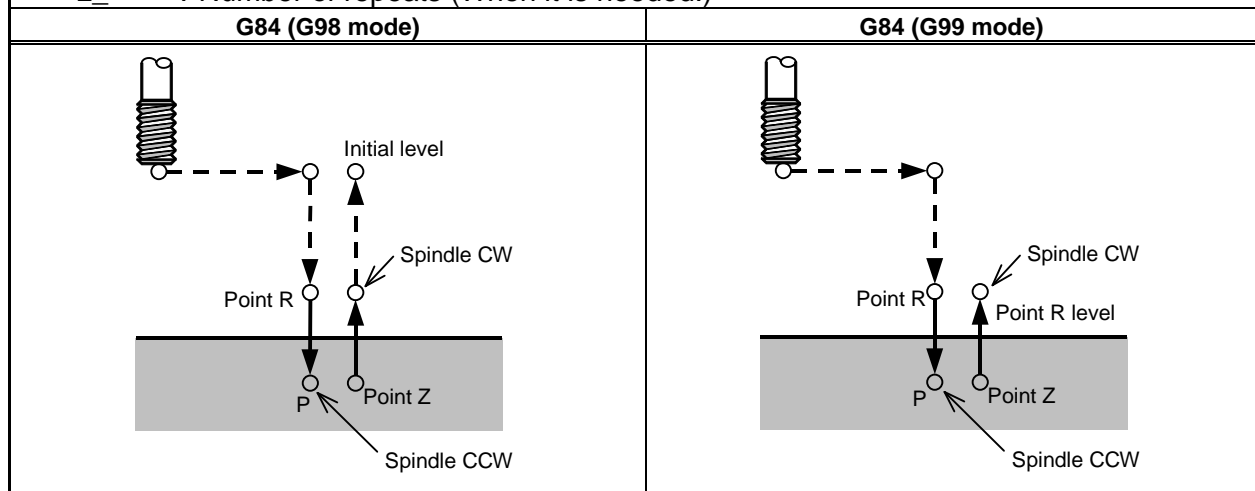

### Explanation

#### - Operations

Tapping is performed by rotating the spindle clockwise.

#### ⚠ CAUTION

Feedrate override is ignored during tapping. In addition, applying feed hold does not stop the machine until return operation is completed.

#### - Spindle rotation

Before specifying G84, use an auxiliary function (M code) to rotate the spindle.

When drilling in which the distance from the hole position and initial level to the point R level is short is continuously performed, the spindle may not reach the normal speed by the time cutting operation for the hole is ready to be performed. In this case, reserve a time by inserting dwelling by G04 before each drilling operation without specifying repetitive count L.

Since this consideration may not be required depending on the machine type, refer to the manual issued by the machine tool builder.

#### - Auxiliary function

If the G84 command and an M code are specified in the same block, the M code is executed at the first positioning. When repetitive count L is specified, the operation above is performed for the first time and the M code is not performed second and later times.

**Limitation****- Axis switching**

Before switching between drilling axes, cancel canned cycles for drilling.

**- Drilling**

In a block that does not include X, Y, Z, R, or an additional axis, drilling is not performed.

**- P**

Dwelling is performed only when address P is specified in a block.

**- Cancel**

The G codes (G00 to G03) in group 01 must not be specified in the block in which G84 is specified. This cancels G84.

**NOTE**

Set M5T (bit 6 of parameter No. 5101) to specify whether the spindle stop command (M05) is specified before the command for rotating the spindle in the forward or reverse direction (M03 or M04) is specified.

For details, refer to the manual issued by the machine tool builder.

**6.5.6 Tapping Cycle (G84.2)**

Controlling the spindle motor in the same way as a servo motor executes the high-speed tapping cycle.

**Format**

**G84.2 X(U)\_ C(H)\_ Z(W)\_ R\_ P\_ F\_ L\_ S\_ ;**

X\_ C\_ or Z\_ C\_ : Hole position data

Z\_ or X\_ : The distance from point R to the bottom of the hole

R\_ : The distance from the initial level to point R level

P\_ : Dwell time

F\_ : Cutting feedrate

L\_ : Number of repeats (When it is needed.)

S\_ : Spindle speed

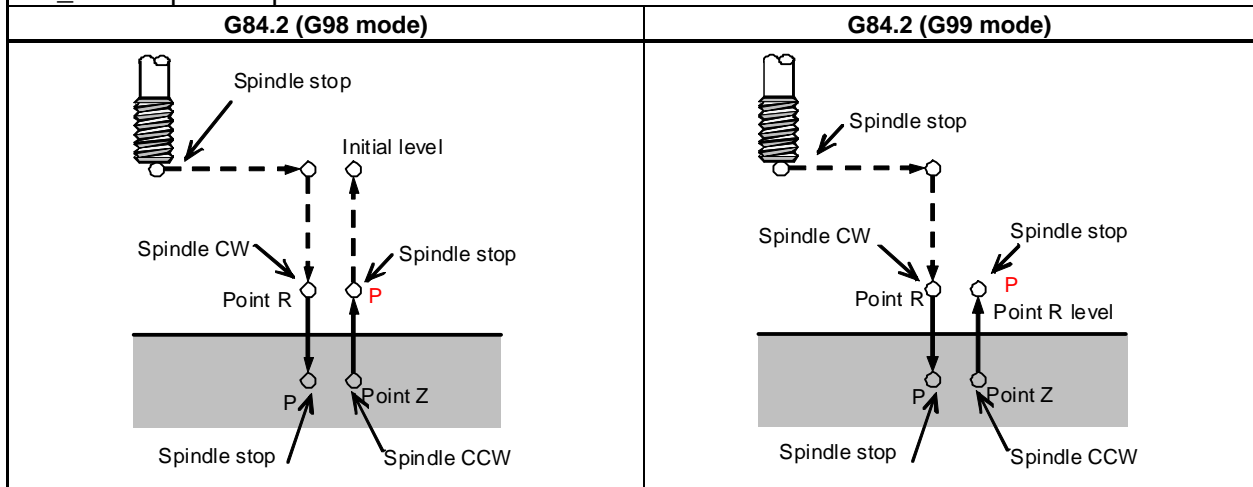

## 6. MEMORY OPERATION

A G code cannot discriminate between the front face tapping cycle and side face tapping cycle using Series 10/11 format commands. The drilling axis is determined by plane selection (G17, G18, or G19). Specify the plane selection that becomes equivalent to the front face tapping cycle or side face tapping cycle as appropriate. (When bit 0 (FXY) of parameter No. 5101 is set to 0, the Z-axis is used as the drilling axis. When the bit is set to 1, plane selection is as follows.)

| Plane selection | Drilling axis |
|-----------------|---------------|
| G17 Xp-Yp plane | Zp            |
| G18 Zp-Xp plane | Yp            |
| G19 Yp-Zp plane | Xp            |

Xp: X-axis or an axis parallel to it

Yp: Y-axis or an axis parallel to it

Zp: Z-axis or an axis parallel to it

---

### Explanation

#### - Operations

The tool is positioned along the X- and Y-axes, then moves to the point R level in rapid traverse.

Tapping is performed from the point R level to point Z, after which the spindle stops and the tool dwells.

Then, the spindle starts reverse rotation, the tool is retracted to the point R level, and the spindle stops.

After that, when G98 is specified, the tool moves to the initial level in rapid traverse.

During tapping, the feedrate override and spindle override are assumed to be 100%. For retraction (operation 5), however, a fixed override of up to 2000% can be applied by setting bit 4 (DOV) of parameter No. 5200, bit 3 (OVU) of parameter No. 5201, and parameter No. 5211.

#### - Thread lead

In the feed per minute mode,  $\text{feedrate} \div \text{spindle speed} = \text{thread lead}$ .

In the feed per rotation mode,  $\text{feedrate} = \text{thread lead}$ .

---

### Limitation

#### - Axis switching

Before switching between drilling axes, cancel canned cycles for drilling. If the drilling axis is changed in the rigid mode, alarm PS0206 is issued.

#### - Drilling

In a block that does not include X, Y, Z, R, or an additional axis, drilling is not performed.

#### - P

Dwelling is performed only when address P is specified in a block.

#### - Cancel

The G codes (G00 to G03) in group 01 must not be specified in the block in which G84.2 is specified. This cancels G84.2.

#### - Tool offset

In the canned cycle mode, tool offsets are ignored.

## 6.5.7 Boring Cycle (G85)

This cycle is used to bore a hole.

### Format

**G85 X\_ Y\_ Z\_ R\_ F\_ L\_ ;**

X\_ Y\_ : Hole position data

Z\_ : The distance from point R to the bottom of the hole

R\_ : The distance from the initial level to point R level

F\_ : Cutting feedrate

L\_ : Number of repeats (When it is needed.)

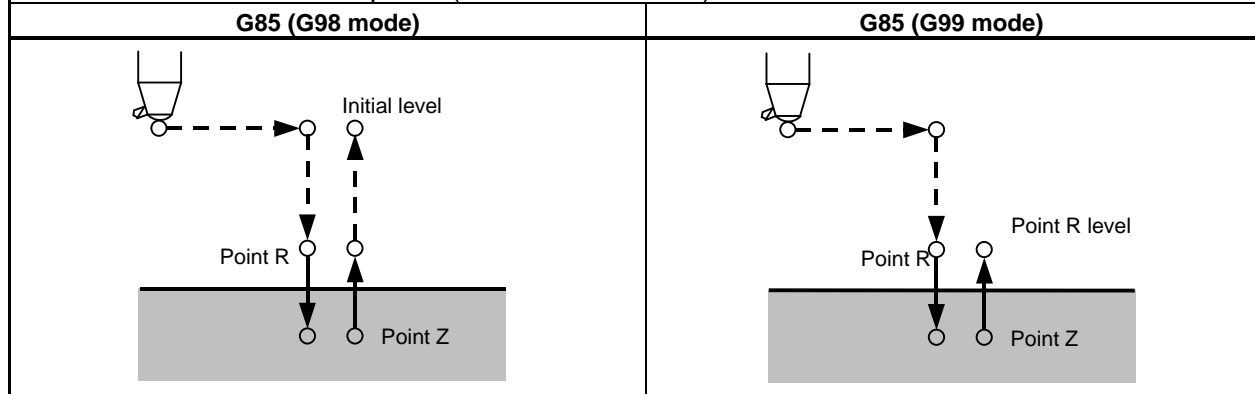

### Explanation

#### - Operations

Rapid traverse to the point R level is performed after positioning of the X- and Y- axes.

Then, drilling is performed from point R level to point Z.

After reaching point Z, return to point R in cutting feed.

#### - Spindle rotation

Before specifying G85, use an auxiliary function (M code) to rotate the spindle.

#### - Auxiliary function

If the G85 command and an M code are specified in the same block, the M code is executed at the first positioning. When repetitive count L is specified, the operation above is performed for the first time and the M code is not performed second and later times.

### Limitation

#### - Axis switching

Before switching between drilling axes, cancel canned cycles for drilling.

#### - Drilling

In a block that does not include X, Y, Z, R, or an additional axis, drilling is not performed.

#### - Cancel

The G codes (G00 to G03) in group 01 must not be specified in the block in which G85 is specified. This cancels G85.

## 6.5.8 Boring Cycle (G89)

This cycle is used to bore a hole.

### Format

**G89 X\_ Y\_ Z\_ R\_ P\_ F\_ L\_ ;**

X\_ Y\_ : Hole position data

Z\_ : The distance from point R to the bottom of the hole

R\_ : The distance from the initial level to point R level

P\_ : Dwell time at the bottom of a hole

F\_ : Cutting feedrate

L\_ : Number of repeats (When it is needed.)

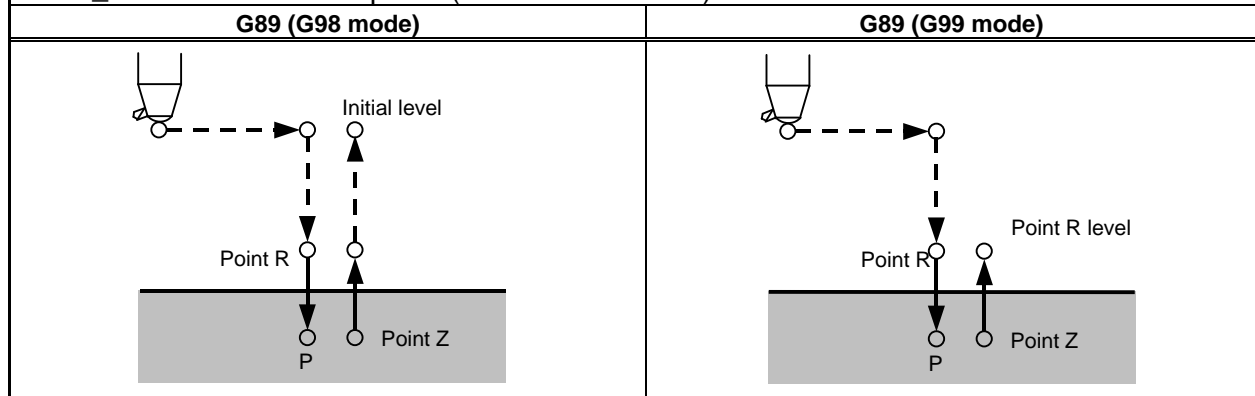

### Explanation

#### - Operations

This is the same as G85, but dwelling is performed at the bottom of the hole.

#### - Spindle rotation

Before specifying G89, use an auxiliary function (M code) to rotate the spindle.

#### - Auxiliary function

If the G89 command and an M code are specified in the same block, the M code is executed at the first positioning. When repetitive count L is specified, the operation above is performed for the first time and the M code is not performed second and later times.

### Limitation

#### - Axis switching

Before switching between drilling axes, cancel canned cycles for drilling.

#### - Drilling

In a block that does not include X, Y, Z, R, or an additional axis, drilling is not performed.

#### - P

P must be specified in a block in which drilling is instructed. Otherwise, data is not stored as modal data.

#### - Cancel

The G codes (G00 to G03) in group 01 must not be specified in the block in which G89 is specified. This cancels G89.

---

## 6.5.9 Canned Cycle for Drilling Cancel (G80)

---

G80 cancels canned cycle for drilling.

---

### Format

|       |
|-------|
| G80 ; |
|-------|

---

### Explanation

Canned cycle for drilling is canceled to perform normal operation. Point R and point Z are cleared. Other drilling data is also canceled (cleared).

---

## 6.5.10 Precautions to be Taken by Operator

---

### - Reset and emergency stop

Even when the controller is stopped by resetting or emergency stop in the course of drilling cycle, the drilling mode and drilling data are saved ; with this mind, therefore, restart operation.

### - Single block

When drilling cycle is performed with a single block, the operation stops at the end points of operations 1, 2, 6 in Fig. 6.5 (a).

Consequently, it follows that operation is started up 3 times to drill one hole. The operation stops at the end points of operations 1, 2 with the feed hold lamp ON. If there is a remaining repetitive count at the end of operation 6, the operation is stopped by feed hold. If there is no remaining repetitive count, the operation is stopped in the single block stop state.

### - Feed hold

When "Feed Hold" is applied between operations 3 and 5 by G84/G88, the feed hold lamp lights up immediately if the feed hold is applied again to operation 6.

### - Override

During operation with G84 and G88, the feedrate override is 100%.

# 7 AXIS CONTROL FUNCTIONS

Chapter 7, "AXIS CONTROL FUNCTIONS", consists of the following sections:

7.1 POLYGON TURNING (G50.2, G51.2) .....298

## 7.1 POLYGON TURNING (G50.2, G51.2)

Polygon turning means machining a workpiece to a polygonal figure by rotating the workpiece and tool at a certain ratio.

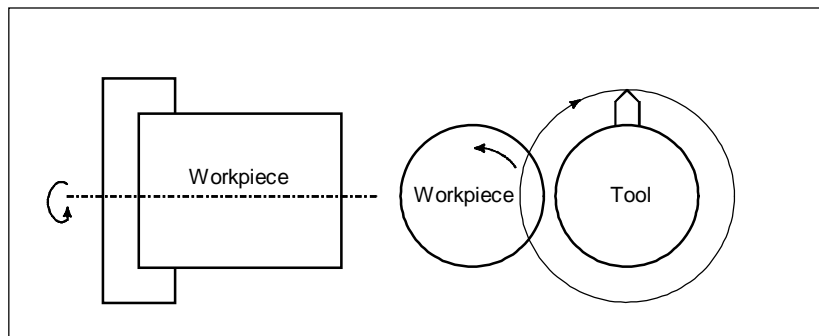

Fig. 7.1 (a) Polygon turning

By changing conditions which are rotation ratio of workpiece and tool and number of cutters, the workpiece can be machined to a square or hexagon. The machining time can be reduced as compared with polygonal figure machining using the polar coordinate interpolation. The machined figure, however, is not exactly polygonal. Generally, polygon turning is used for the heads of square and/or hexagon bolts or hexagon nuts.

As the tool rotary axis, one of the following can be used:

- CNC controlled axis (servo axis)
- Second spindle (Two serial spindles are connected.)

Polygonal machining performed using a servo axis as the tool rotary axis is referred to as polygon turning. Polygonal machining performed using the second spindle as the tool rotary axis is referred to as polygon turning with two spindles.

| Function name                     | Workpiece axis   | Tool rotary axis            |
|-----------------------------------|--|-----------------------------|
| Polygon turning                   | Spindle<br>(Either an analog spindle or serial spindle is usable. However, a detector equivalent to a position coder is required.) | Servo axis                  |
| Polygon turning with two spindles | Spindle<br>(Serial spindle)  | Spindle<br>(Serial spindle) |

### Explanation

A CNC controlled axis (servo axis) is assigned to the tool rotary axis.

This rotary axis of tool is called Y-axis in the following description. As the workpiece axis (spindle), either a serial spindle or analog spindle can be used.

The Y-axis is controlled by the G51.2 command, so that the ratio of the rotation speeds of the spindle (previously specified by S-command) and the tool becomes the specified ratio.

When simultaneous start is specified by G51.2, the one-rotation signal sent from the position codes set on the spindle is detected. After one-rotation signal detection, the Y-axis is controlled using the rotation ratio of the spindle and Y-axis specified by P and Q. So, a position coder needs to be attached to the spindle.



This control will be maintained until the polygon turning cancel command is executed (G50.2). Polygon turning is cancelled by any of the following in addition to the G50.2 command:

- (1) Power off
- (2) Emergency stop
- (3) Servo alarm
- (4) Reset (external reset signal ERS, reset/rewind signal RRW, and RESET key on the MDI unit)  
In polygon turning with two spindles, setting bit 0 (RPL) of parameter No.7603 to 1 prevents polygon synchronization mode from being released by reset.
- (5) Occurrence of alarms PS0217 to PS0221, PS0314, and PS05018

**NOTE**

- 1 Before polygon turning, reference position return operation on the Y-axis needs to be specified to determine the rotation start position of the tool. This reference position return operation is performed by detecting a deceleration limit as in the case of manual reference position return operation. (By setting bit 7 (PLZ) of parameter No. 7600, reference position return operation can be performed without detecting a deceleration limit.)
- 2 The rotation direction on the Y-axis is determined by the sign of Q, and is not affected by the rotation direction of the position coder.
- 3 Among the current position display of the Y axis, the display for the machine coordinate value (MACHINE) changes from a range of 0 to the amount of movement per revolution as the Y axis moves. Absolute and relative coordinate values are not updated. So, when specifying an absolute programming for the Y-axis after polygon turning mode cancellation, set a workpiece coordinate system after reference position return operation.
- 4 For the Y-axis engaged in polygon turning, jog feed and handle feed are disabled.
- 5 For the Y-axis not engaged in polygon turning, a move command can be specified as in the case of other controlled axes.
- 6 The Y-axis engaged in polygon turning is not counted in the number of simultaneously controlled axes.
- 7 One workpiece must be machined using a fixed spindle speed until the workpiece is finished.
- 8 G50.2 is the G code for suppressing buffering.
- 9 The following functions must be commanded with polygon turning cancel mode.
  - Inch/metric conversion
  - AI Advanced Preview Control (M Series)/AI Contour Control I/AI Contour Control II
  - Tilted working plane indexing (M series)
  - Nano smoothing (M series)
  - Flexible path axis assignment

**⚠ CAUTION**

- 1 During polygon turning, threading cannot be performed.
- 2 For the Y-axis engaged in polygon turning, the signals below are valid or invalid:

Signals valid for the Y-axis

- Machine lock
- Servo-off

Signals invalid for the Y-axis

- Feed hold
- Interlock
- Override
- Dry run

(In the dry run, workpiece might not be processed to the expected shape because the one-rotation signal is not awaited though the speed of a dry run is invalid.)

**Format**

**G50.2** Polygon turning cancel

**G51.2 P\_ Q\_ [R\_];** Start of polygon turning

P,Q: Rotation ratio of spindle and Y-axis

R : Relative phase difference between spindle and Y-axis (\*1)

Specify range:

P: Integer from 1 to 999

Q: Integer from -999 to -1 or from 1 to 999

When Q is a positive value, Y-axis makes positive rotation.

When Q is a negative value, Y-axis makes negative rotation.

R: 0 to 360 degrees

The unit of data is depend on the increment system of the reference axis.

The decimal point can be used.

If a value out of range is specified, it is rounded in 0 to 360 degrees.

(\*1) R can be specified in polygon turning with two spindles.

The least command increment of R is 360/4096 degrees, and the value less than the least command increment is rounded off.

R may be omitted. If R is not specified after starting polygon turning with two spindles, the phase difference is assumed to be 0. Even if R is not specified, phase adjustment is performed.

If bit 5 (COF) of parameter No. 7602 is 1 to disable phase control, R is ignored.

**NOTE**

Specify G50.2 and G51.2 in a single block.

**Example**

G00 X100.0 Z20.0 S1000.0 M03 ; (Workpiece rotation speed 1000 (min<sup>-1</sup>))  
 G51.2 P1 Q2 ; (Tool rotation start (tool rotation speed 2000 (min<sup>-1</sup>)))  
 G01 X80.0 F10.0 ; (X-axis infeed)  
 G04 X2.0 ; (Waiting 2 seconds)  
 G00 X100.0 ; (X-axis escape)  
 G50.2 ; (Tool rotation stop)  
 M05 S0 ; (Spindle stop )

**- Principle of polygon turning**

The principle of polygon turning is explained below. In the figure (Fig. 7.1 (b)) below the radius of tool and workpiece are A and B, and the angular speeds of tool and workpiece are  $\alpha$  and  $\beta$ . The origin of XY Cartesian coordinates is assumed to be the center of the workpiece.

Simplifying the explanation, consider that the tool center exists at the position  $P_o (A, 0)$  on the workpiece periphery, and the tool nose starts from position  $P_{to} (A-B, 0)$ .

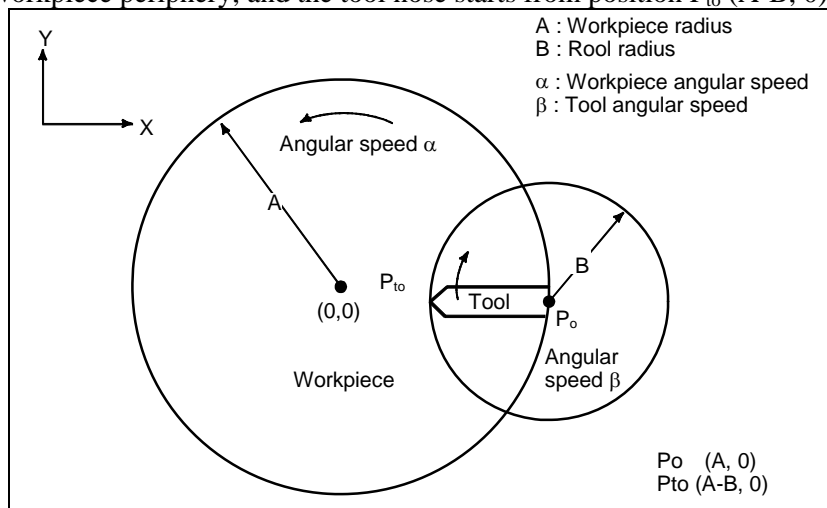

**Fig. 7.1 (b) Principle of polygon turning**

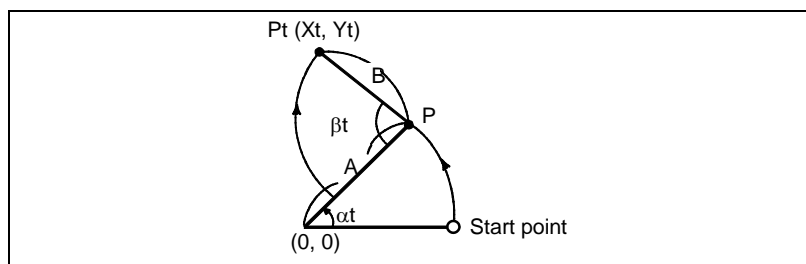

**Fig. 7.1 (c) Tool nose position**

In this case, the tool nose position  $P_t (X_t, Y_t)$  after time  $t$  is expressed by equations 1 and 2:

$$X_t = A \cos \alpha t - B \cos (\beta - \alpha) t \quad \text{(Equation 1)}$$

$$Y_t = A \sin \alpha t + B \sin (\beta - \alpha) t \quad \text{(Equation 2)}$$

Assuming that the rotation ratio of workpiece to tool is 1:2, namely,  $\beta = 2\alpha$ , equations 1 and 2 are modified as follows:

$$X_t = A \cos \alpha t - B \cos \alpha t = (A - B) \cos \alpha t \quad \text{(Equation 1)'}$$

$$Y_t = A \sin \alpha t + B \sin \alpha t = (A + B) \sin \alpha t \quad \text{(Equation 2)'}$$

These equations indicate that the tool nose path draws an ellipse with longer diameter  $A+B$  and shorter diameter  $A-B$ .

Then consider the case when one tool is set at 180° symmetrical positions, for a total of two. A square can be machined with these tools as shown below.

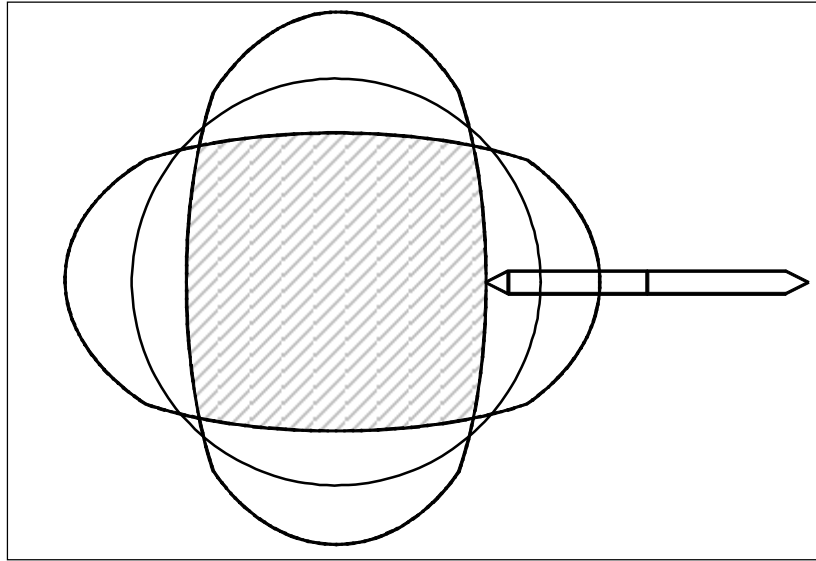

If three tools are set at every  $120^\circ$ , the machining figure will be a hexagon as shown below.

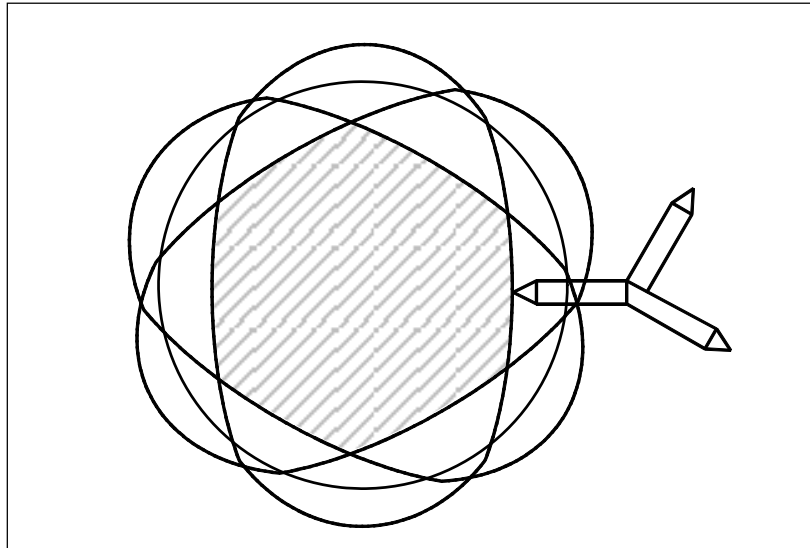

**⚠ WARNING**

For the maximum rotation speed of the tool, see the instruction manual supplied with the machine. Do not specify a spindle speed higher than the maximum tool speed or a ratio to the spindle speed that results in a speed higher than the maximum tool speed.

# 8 MULTI-PATH CONTROL FUNCTION

Chapter 8, "MUITI-PATH CONTROL FUNCTION", consists of the following sections:

8.1 BALANCE CUT (G68, G69) .....303

## 8.1 BALANCE CUT (G68, G69)

### Overview

When a thin workpiece is to be machined as shown below, a precision machining can be achieved by machining each side of the workpiece with a tool simultaneously; this function can prevent the workpiece from warpage that can result when only one side is machined at a time (see the Fig. 8.1 (a)). When both sides are machined at the same time, the movement of one tool must be in phase with that of the other tool. Otherwise, the workpiece can vibrate, resulting in poor machining. With this function, the movement of one tool post can be easily synchronized with that of the other tool post.

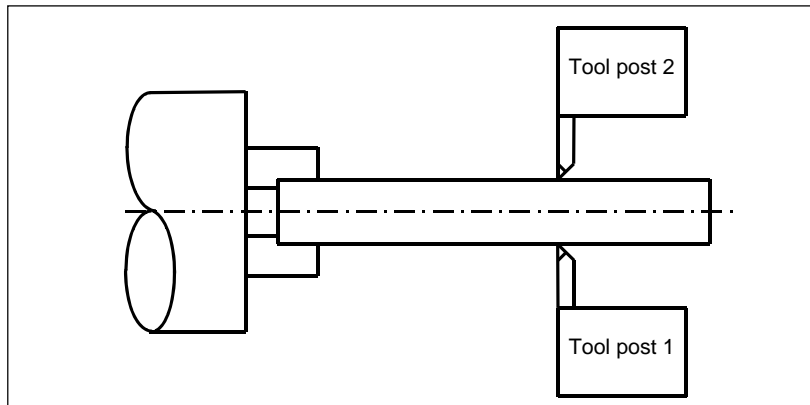

Fig. 8.1 (a)

#### NOTE

- 1 This function is an optional function.
- 2 The balance cut is available when bit 0 (NVC) of parameter No.8137 is 0. Though, when the mirror image for double turret is selected, the balance cut cannot be used. To use the mirror image for double turret, set 0 to bit 0 (NVC) of parameter No. 8137 to disable the balance cut.

### Format

**G68 ; Balance cut mode on**  
**G69; Balance cut mode cancel**

### Explanation

When G68 is specified in the programs for tool posts 1 and 2, the balance cut mode is set to on. When G69 is specified, the balance cut mode is canceled.

When G68 or G69 is specified for either tool post, the tool post waits until G68 or G69 is specified for the other tool post.

In the balance cut mode, balance cutting is performed when a move command in cutting feed is specified for both tool posts.

In balance cutting, the tool posts start moving simultaneously in each block in which a move command in cutting feed is specified.

Specify G68 or G69 in a single block.

If G68 or G69 is specified incorrectly, alarm PS0163 occurs.

**NOTE**

- 1 Balance cutting is not performed in dry run or machine lock state. G68 or G69 specified for one tool post is synchronized with G68 or G69 specified for the other tool post, however.
- 2 In the balance cut mode, G68 specified for one tool post is not synchronized with G68 specified for the other tool post. In the balance cut cancel mode, G69 specified for one tool post is not synchronized with G69 specified for the other tool post.
- 3 Balance cutting is not performed in a block in which 0 is specified for the travel distance.
- 4 Balance cutting is not performed when rapid traverse is specified.

 **CAUTION**

- 1 Balance cut only starts cutting feed on both tool posts at the same time; it does not maintain synchronization thereafter. To synchronize all the movements of both tool posts, the setting for both tool posts, such as the travel distance and feedrate, must be the same. Override and interlock can be applied independently to both tool posts. The settings for both tool posts that are related to override and interlock must also be the same to perform balance cutting.
- 2 After feed hold is applied during execution of balance cutting for both tool posts, balance cutting is not performed at the restart. Balance cutting is performed when the next move command is executed for both tool posts.

**NOTE**

- 1 Time delay before the pulse distribution of both tool posts is started is 2 msec or shorter.
- 2 Overlap is invalid. In the balance cut mode, synchronization is established at the start of each move block in which cutting is specified, so movement can momentarily stop.
- 3 In the balance cut mode, continuous thread cutting overlap is also invalid. Perform continuous thread cutting in the balance cut cancel mode.
- 4 To establish synchronization at the start of pulse distribution in a block in which thread cutting is specified, the same position coder must be selected.
- 5 The cancel mode (G69) is unconditionally set by a reset.

### **III. OPERATION**





# 1 DATA INPUT/OUTPUT

By using the memory card interface and the USB memory interface on the left side of the display, information written in a memory card and USB memory is input into the CNC and information is written from the CNC to a memory card and USB memory.

The following types of data can be input and output:

1. Y-axis offset data
2. Tool offset / 2nd geometry data
3. 4th/5th axis offset data

The above data can be input and output on the screens used for displaying and setting the data and on the ALL IO screen.

Chapter 1, "DATA INPUT/OUTPUT", consists of the following sections:

|         |  |     |
|---------|--|-----|
| 1.1     | INPUT/OUTPUT ON EACH SCREEN .....                                    | 307 |
| 1.1.1   | Inputting and Outputting Y-axis Offset Data.....                     | 307 |
| 1.1.1.1 | Inputting Y-axis offset data .....                                   | 307 |
| 1.1.1.2 | Outputting Y-axis Offset Data.....                                   | 308 |
| 1.1.2   | Inputting and Outputting Tool Offset / 2nd Geometry Data.....        | 309 |
| 1.1.2.1 | Inputting tool offset / 2nd geometry data .....                      | 309 |
| 1.1.2.2 | Outputting tool offset / 2nd geometry data.....                      | 310 |
| 1.1.3   | Inputting and Outputting 4th/5th Axis Offset Data .....              | 311 |
| 1.1.3.1 | Inputting 4th/5th axis offset data.....                              | 311 |
| 1.1.3.2 | Outputting 4th/5th Axis Offset Data .....                            | 312 |
| 1.2     | INPUT/OUTPUT ON THE ALL IO SCREEN .....                              | 314 |
| 1.2.1   | Inputting and Outputting Y-axis Offset Data.....                     | 315 |
| 1.2.2   | Inputting and Outputting Tool Offset / 2nd Geometry Tool Offset..... | 316 |

## 1.1 INPUT/OUTPUT ON EACH SCREEN

Data can be input to and output from the Y-axis offset and tool offset/second geometry operation screens.

### 1.1.1 Inputting and Outputting Y-axis Offset Data

#### NOTE

When bit 1 (YOF) of parameter No.8132 is 1, "Y-axis offset" can be used.



#### 1.1.1.1 Inputting Y-axis offset data

Y-axis offset data is loaded into the memory of the CNC from such as memory card. The input format is the same as the output format. The Y-axis offset data that is registered in the memory and has a corresponding data number is replaced with data input by this operation.

#### Inputting Y-axis offset data (for 8.4/10.4-inch display unit)

##### Procedure

- 1 Make sure the input device is ready for inputting.
- 2 Press the EDIT switch on the machine operator's panel.
- 3 Press function key .

- 4 Press the continuous menu key  several times until soft key [Y OFFSET] appears.
- 5 Press soft key [Y OFFSET] to display the Y-axis offset data. screen.
- 6 Press soft key [(OPRT)].
- 7 Press the continuous menu key  several times until soft key [F INPUT] appears.
- 8 Press soft key [F INPUT].
- 9 Type the name of the file that you want to input.  
If the input file name is omitted, default input file name "TOOLOFST.TXT" is assumed.
- 10 Press soft key [EXEC].  
This starts inputting the Y-axis offset data, and "INPUT" blinks in the lower right part of the screen.  
When the input operation ends, the "INPUT" indication disappears.  
To cancel the input, press soft key [CANCEL].

---

### Inputting Y-axis offset data (for 15-inch display unit)

---

#### Procedure

- 1 Make sure the input device is ready for inputting.
- 2 Press the EDIT switch on the machine operator's panel.
- 3 Press function key .
- 4 Press vertical soft key [NEXT PAGE] several times until soft key [Y OFFSET] is displayed.
- 5 Press vertical soft key [Y OFFSET] to display the Y-axis offset data screen.
- 6 Press horizontal soft key [F INPUT].
- 7 Type the name of the file that you want to input.  
If the input file name is omitted, default input file name "TOOLOFST.TXT" is assumed.
- 8 Press horizontal soft key [EXEC].  
This starts inputting the Y-axis offset data, and "INPUT" blinks in the lower right part of the screen.  
When the input operation ends, the "INPUT" indication disappears.  
To cancel the input, press horizontal soft key [CANCEL].

### 1.1.1.2 Outputting Y-axis Offset Data

---



Y-axis offset data is output in a output format from the memory of the CNC to such as memory card.

---

### Outputting Y-axis offset data (for 8.4/10.4-inch display unit)

---

#### Procedure

- 1 Make sure the output device is ready for outputting.
- 2 Press the EDIT switch on the machine operator's panel.
- 3 Press function key .
- 4 Press the continuous menu key  several times until soft key [Y OFFSET] appears.
- 5 Press soft key [Y OFFSET] to display the Y-axis offset data. screen.
- 6 Press soft key [(OPRT)].
- 7 Press the continuous menu key  several times until soft key [F OUTPUT] appears.
- 8 Press soft key [F OUTPUT].
- 9 Type the file name that you want to output.  
If the file name is omitted, default file name "TOOLOFST.TXT" is assumed.
- 10 Press soft key [EXEC].  
This starts outputting the Y-axis offset data, and "OUTPUT" blinks in the lower right part of the screen. When the output operation ends, the "OUTPUT" indication disappears.  
To cancel the output, press soft key [CANCEL].

## Outputting Y-axis offset data (for 15-inch display unit)

### Procedure

- 1 Make sure the output device is ready for outputting.
- 2 Press the EDIT switch on the machine operator's panel.
- 3 Press function key .
- 4 Press vertical soft key [NEXT PAGE] several times until soft key [Y OFFSET] is displayed.
- 5 Press vertical soft key [Y OFFSET] to display the Y-axis offset data screen.
- 6 Press horizontal soft key [F OUTPUT].
- 7 Type the file name that you want to output.  
If the file name is omitted, default file name "TOOLOFST.TXT" is assumed.
- 8 Press horizontal soft key [EXEC].  
This starts outputting the Y-axis offset data, and "OUTPUT" blinks in the lower right part of the screen. When the output operation ends, the "OUTPUT" indication disappears.  
To cancel the output, press horizontal soft key [CANCEL].

## 1.1.2 Inputting and Outputting Tool Offset / 2nd Geometry Data

### NOTE



"2nd Geometry Tool Offset" is an optional function.  
To use the "2nd Geometry Tool Offset", this option and "Tool geometry offset and Tool wear offset" are required. "Tool geometry offset and Tool wear offset" can be used, when bit 6 (NGW) of parameter No.8136 is 0.

### 1.1.2.1 Inputting tool offset / 2nd geometry data

Tool offset / 2nd geometry data is loaded into the memory of the CNC from such as memory card. The input format is the same as the output format. The tool offset / 2nd geometry data that is registered in the memory and has a corresponding data number is replaced with data input by this operation.

## Inputting tool offset / 2nd geometry data (for 8.4/10.4-inch display unit)

### Procedure

- 1 Make sure the input device is ready for inputting.
- 2 Press the EDIT switch on the machine operator's panel.
- 3 Press function key .
- 4 Press the continuous menu key  several times until soft key [2ND GEOM] appears.
- 5 Press soft key [2ND GEOM] to display the offset / 2nd geometry data screen.
- 6 Press soft key [(OPRT)].
- 7 Press the continuous menu key  several times until soft key [F INPUT] appears.
- 8 Press soft key [F INPUT].
- 9 Type the name of the file that you want to input.  
If the input file name is omitted, default input file name "SEC\_GEOM.TXT" is assumed.
- 10 Press soft key [EXEC].  
This starts inputting the 2nd geometry data, and "INPUT" blinks in the lower right part of the screen. When the input operation ends, the "INPUT" indication disappears.  
To cancel the input, press soft key [CANCEL].

---

### Inputting tool offset / 2nd geometry data (for 15-inch display unit)

---

#### Procedure

- 1 Make sure the input device is ready for inputting.
- 2 Press the EDIT switch on the machine operator's panel.
- 3 Press function key .
- 4 Press vertical soft key [NEXT PAGE] several times until soft key [2ND GEOM] is displayed.
- 5 Press vertical soft key [2ND GEOM] to display the Y-axis offset data screen.
- 6 Press horizontal soft key [F INPUT].
- 7 Type the name of the file that you want to input.  
If the input file name is omitted, default input file name "SEC\_GEOM.TXT" is assumed.
- 8 Press horizontal soft key [EXEC].  
This starts inputting the 2nd geometry data, and "INPUT" blinks in the lower right part of the screen.  
When the input operation ends, the "INPUT" indication disappears.  
To cancel the input, press horizontal soft key [CANCEL].

### 1.1.2.2 Outputting tool offset / 2nd geometry data

---



Tool offset / 2nd geometry data is output in a output format from the memory of the CNC to such as memory card.

---

### Outputting tool offset / 2nd geometry data (for 8.4/10.4-inch display unit)

---

#### Procedure

- 1 Make sure the output device is ready for outputting.
- 2 Press the EDIT switch on the machine operator's panel.
- 3 Press function key .
- 4 Press the continuous menu key  several times until soft key [2ND GEOM] appears.
- 5 Press soft key [2ND GEOM] to display the offset / 2nd geometry data screen.
- 6 Press soft key [(OPRT)].
- 7 Press the continuous menu key  several times until soft key [F OUTPUT] appears.
- 8 Press soft key [F OUTPUT].
- 9 Type the file name that you want to output.  
If the file name is omitted, default file name "SEC\_GEOM.TXT" is assumed.
- 10 Press soft key [EXEC].  
This starts outputting the 2nd geometry data, and "OUTPUT" blinks in the lower right part of the screen. When the output operation ends, the "OUTPUT" indication disappears.  
To cancel the output, press soft key [CANCEL].

---

### Outputting tool offset / 2nd geometry data (for 15-inch display unit)

---

#### Procedure

- 1 Make sure the output device is ready for outputting.
- 2 Press the EDIT switch on the machine operator's panel.
- 3 Press function key .
- 4 Press vertical soft key [NEXT PAGE] several times until soft key [2ND GEOM] is displayed.
- 5 Press vertical soft key [2ND GEOM] to display the Y-axis offset data screen.
- 6 Press horizontal soft key [F OUTPUT].
- 7 Type the file name that you want to output.  
If the file name is omitted, default file name "SEC\_GEOM.TXT" is assumed.
- 8 Press horizontal soft key [EXEC].  
This starts outputting the 2nd geometry data, and "OUTPUT" blinks in the lower right part of the

screen. When the output operation ends, the "OUTPUT" indication disappears.  
To cancel the output, press horizontal soft key [CANCEL].

## 1.1.3 Inputting and Outputting 4th/5th Axis Offset Data

### NOTE



"4th/5th axis offset" is an optional function.

### 1.1.3.1 Inputting 4th/5th axis offset data

Tool offset values can be input through an I/O device. Tool offset values can also be input by using the ALL IO function.

#### Inputting 4th/5th axis offset data (for 8.4/10.4-inch display unit)

##### Procedure

- 1 Make sure the input device is ready for inputting.
- 2 Press the EDIT switch on the machine operator's panel.
- 3 Press function key .
- 4 Press the continuous menu key  several times until soft key [OFFSET] or [EXTEND OFFSET] is displayed.
- 5 Press soft key [OFFSET] or [EXTEND OFFSET] to display the offset screen or 4th/5th axis offset screen.
- 6 Press soft key [(OPRT)].
- 7 Press soft key [F INPUT].
- 8 Press soft key [EXEC].

The input format for tool offset values based on the G10 command is used.

### NOTE

When a program written in the input format for tool offset values based on the G10 command is input, all offset values corresponding to the axis addresses and offset numbers specified in the program are rewritten.  
However, the data of a function with no option specified is ignored.

#### Inputting 4th/5th axis offset data (for 15-inch display unit)

##### Procedure

- 1 Make sure the input device is ready for inputting.
- 2 Press the EDIT switch on the machine operator's panel.
- 3 Press function key .
- 4 Press vertical soft key [NEXT PAGE] several times until vertical soft key [OFFSET] or [EXTEND OFFSET] is displayed.
- 5 Press vertical soft key [OFFSET] or [EXTEND OFFSET] to display the offset screen or 4th/5th axis offset screen.
- 6 Press horizontal soft key [F INPUT].
- 7 Press horizontal soft key [EXEC].

The input format for tool offset values based on the G10 command is used.



**NOTE**

When a program written in the input format for tool offset values based on the G10 command is input, all offset values corresponding to the axis addresses and offset numbers specified in the program are rewritten.  
However, the data of a function with no option specified is ignored.

**1.1.3.2 Outputting 4th/5th Axis Offset Data**

Tool offset values can be output to an I/O device.

**Outputting 4th/5th axis offset data (for 8.4/10.4-inch display unit)****Procedure**

- 1 Make sure the input device is ready for inputting.
- 2 Press the EDIT switch on the machine operator's panel.
- 3 Press function key .
- 4 Press the continuous menu key  several times until soft key [OFFSET] or [EXTEND OFFSET] is displayed.
- 5 Press soft key [OFFSET] or [EXTEND OFFSET] to display the offset screen or 4th/5th axis offset screen.
- 6 Press soft key [(OPRT)].
- 7 Press soft key [F OUTPUT].
- 8 Press soft key [EXEC].

The output format used is the absolute tool offset value format based on the G10 command.

- Example of output data

When the 4th/5th axis offset function are specified, and 32 sets of tool offsets are used

%

G10 P01 X1.250 Z1.750 R12.254 Y2.250 E2.750 F12.600 ;

:

G10 P32 X0.840 Z1.240 R11.435 Y1.640 E2.040 F7.675 ;

G10 P10001 X9.680 Z9.280 R12.224 Y8.880 E8.480 F24.345 ;

:

G10 P10032 X9.450 Z9.000 R13.017 Y8.550 E8.100 F10.123 ;

%

Tool geometry/wear offset values as many as the number of tool offset sets are output.

**NOTE**

When compared with the G10 format used for output of tool offset values, address E for indicating a 4th axis offset value and address F for indicating a 5th axis offset value are added in the output format.

**- Address name changing of output format**

When bit 2 (OFN) of parameter No.11403 is set to 1, the specification address in "Y-axis offset and 4th/5th axis offset" can use address name 'A' or 'B' instead of default specification address 'Y', 'E' and 'F'.

Example) When parameter is set to follow, the address is changed.

- Parameter No.5044 is set to 4 (4th axis offset is the 4th axis)
- Parameter No.5045 is set to 5 (5th axis offset is the 5th axis)
- Parameter No.1020 (4th axis ,5th axis) = 65, 66 (Address name of 4th /5th axis offset is 'A' and 'B')

- Bit 2 (OFN) of parameter No.11403 is set to 1 (Address depend on parameter No.1020)

%

G10 P01 X\_ Z\_ A\_ B\_

G10 P02 X\_ Z\_ A\_ B\_

...

G10 P\_\_ X\_ Z\_ A\_ B\_

%

A\_ : Tool compensation data (4th axis offset value in example).

B\_ : Tool compensation data (5th axis offset value in example).

The other addresses are the same as for the tool compensation amount.

#### NOTE

- 1 The axis name that can be used as a specification address is only 'A', and 'B'.  
If specification address 'A' or 'B' is used, the address 'V' (incremental command of Y-axis offset) cannot be used.
- 2 When setting is the following condition, the default specification addresses 'Y', 'E' and 'F' are used.
  - Parameter No.1020 is set to axis name other than 'A(65)' or 'B(66)'.
  - An extended axis name is used.
- 3 When bit 2 of parameter No.11403 is set to 1, conventional offset data cannot be read. If conventional offset data is read, Please set 0 to bit 2 (OFN) of parameter No.11403.

### Outputting 4th/5th axis offset data (for 15-inch display unit)

#### Procedure

- 1 Make sure the input device is ready for inputting.
- 2 Press the EDIT switch on the machine operator's panel.
- 3 Press function key .
- 4 Press vertical soft key [NEXT PAGE] several times until vertical soft key [OFFSET] or [EXTEND OFFSET] is displayed.
- 5 Press vertical soft key [OFFSET] or [EXTEND OFFSET] to display the offset screen or 4th/5th axis offset screen.
- 6 Press horizontal soft key [F OUTPUT].
- 7 Press horizontal soft key [EXEC].

The output format used is the absolute tool offset value format based on the G10 command.

- Example of output data

When the 4th/5th axis offset function are specified, and 32 sets of tool offsets are used

%

G10 P01 X1.250 Z1.750 R12.254 Y2.250 E2.750 F12.600 ;

:

G10 P32 X0.840 Z1.240 R11.435 Y1.640 E2.040 F7.675 ;

G10 P10001 X9.680 Z9.280 R12.224 Y8.880 E8.480 F24.345 ;

:

G10 P10032 X9.450 Z9.000 R13.017 Y8.550 E8.100 F10.123 ;

%

Tool geometry/wear offset values as many as the number of tool offset sets are output.

**NOTE**

When compared with the G10 format used for output of tool offset values, address E for indicating a 4th axis offset value and address F for indicating a 5th axis offset value are added in the output format.

**- Address name changing of output format**

When bit 2 of parameter No.11403 is set to 1, the specification address in "Y-axis offset and 4th/5th axis offset" can use address name 'A' or 'B' instead of default specification addresses 'Y', 'E' and 'F'.

Example) When parameter is set to follow, the address is changed.

- No.5044 is set to 4 (4th axis offset is the 4th axis)
- No.5045 is set to 5 (5th axis offset is the 5th axis)
- No.1020 (4th axis ,5th axis) = 65, 66 (Address name of 4th /5th axis offset is 'A' and 'B')
- Bit 2 of No.11403 is set to 1 (Address depend on parameter No.1020)

%

**G10 P01 X\_ Z\_ A\_ B\_**

**G10 P02 X\_ Z\_ A\_ B\_**

...

**G10 P\_\_ X\_ Z\_ A\_ B\_**

%

A\_ : Tool compensation data (4th axis offset).

B\_ : Tool compensation data (5th axis offset).

The other addresses are the same as for the tool compensation amount.

**NOTE**

- 1 The axis name that can be used as a specification address is only 'A', and 'B'. If specification address 'A' or 'B' is used, the address 'V' (incremental command of Y-axis offset) cannot be used.
- 2 When setting is the following condition, the default specification addresses 'Y', 'E', and 'F' are used.
  - Parameter No.1020 is set to axis name other than 'A(65)' or 'B(66)'.
  - An extended axis name is used.
- 3 When bit 2 of parameter No.11403 is set to 1, conventional offset data cannot be read. If conventional offset data is read, Please set 0 to bit 2 of parameter No.11403.



## 1.2 INPUT/OUTPUT ON THE ALL IO SCREEN

Just by using the ALL IO screen, you can input and output Y-axis offset data and tool offset / 2nd geometry data.

The following explains how to display the ALL IO screen:

### Displaying the ALL IO screen (for 8.4/10.4-inch display unit)

#### Procedure

- 1 Press function key .
- 2 Press the continuous menu key  several times until soft key [ALL IO] is displayed.



- 3 Press soft key [ALL IO] to display the ALL IO screen.

The subsequent steps to select data from the ALL IO screen will be explained for each type of data.

---

## Displaying the ALL IO screen (for 15-inch display unit)

---

### Procedure

- 1 Press function key .
- 2 Press vertical soft key [NEXT PAGE] several times until vertical soft key [ALL IO] is displayed.
- 3 Press vertical soft key [ALL IO] to display the ALL IO screen.

The subsequent steps to select data from the ALL IO screen will be explained for each type of data.

## 1.2.1 Inputting and Outputting Y-axis Offset Data

---

With the lathe system, Y-axis offset data can be input and output using the ALL IO screen.

### NOTE

When bit 1 (YOF) of parameter No.8132 is 1, "Y-axis offset" can be used.

---

## Inputting Y-axis offset data (for 8.4/10.4-inch display unit)

---

### Procedure

- 1 Press the continuous menu key  on the ALL IO screen several times until soft key [Y OFFSET] is displayed.
- 2 Press soft key [Y OFFSET].
- 3 Select EDIT mode.
- 4 Press soft key [(OPRT)].
- 5 Press soft key [N INPUT].
- 6 Set the name of the file that you want to input.  
Type a file name, and press soft key [F NAME].  
If the input file name is omitted, default file name "TOOLOFST.TXT" is assumed.
- 7 Press soft key [EXEC].  
This starts inputting the Y-axis offset data, and "INPUT" blinks in the lower right part of the screen.  
When the input operation ends, the "INPUT" indication disappears.  
To cancel the input, press soft key [CANCEL].

---

## Inputting Y-axis offset data (for 15-inch display unit)

---

### Procedure

- 1 Press vertical soft key [NEXT PAGE] on the ALL IO screen several times until vertical soft key [Y OFFSET] is displayed.
- 2 Press vertical soft key [Y OFFSET].
- 3 Select EDIT mode.
- 4 Press horizontal soft key [N INPUT].
- 5 Set the name of the file that you want to input.  
Type a file name, and press soft key [F NAME].  
If the input file name is omitted, default file name "TOOLOFST.TXT" is assumed.
- 6 Press horizontal soft key [EXEC].  
This starts inputting the Y-axis offset data, and "INPUT" blinks in the lower right part of the screen.  
When the input operation ends, the "INPUT" indication disappears.  
To cancel the input, press horizontal soft key [CANCEL].

---

**Outputting Y-axis offset data (for 8.4/10.4-inch display unit)**

---

**Procedure**

- 1 Press the continuous menu key  on the ALL IO screen several times until soft key [Y OFFSET] is displayed.
- 2 Press soft key [Y OFFSET].
- 3 Select EDIT mode.
- 4 Press soft key [(OPRT)].
- 5 Press soft key [F OUTPUT].
- 6 Set the file name to be output.  
Type a file name, and press soft key [F NAME].  
If the file name is omitted, default file name "TOOLOFST.TXT" is assumed.
- 7 Press soft key [EXEC].  
This starts outputting the Y-axis offset data, and "OUTPUT" blinks in the lower right part of the screen. When the output operation ends, the "OUTPUT" indication disappears.  
To cancel the output, press soft key [CANCEL].

---

**Outputting Y-axis offset data (for 15-inch display unit)**

---

**Procedure**

- 1 Press vertical soft key [NEXT PAGE] on the ALL IO screen several times until vertical soft key [Y OFFSET] is displayed.
- 2 Press vertical soft key [Y OFFSET].
- 3 Select EDIT mode.
- 4 Press horizontal soft key [F OUTPUT].
- 5 Set the file name to be output.  
Type a file name, and press soft key [F NAME].  
If the file name is omitted, default file name "TOOLOFST.TXT" is assumed.
- 6 Press horizontal soft key [EXEC].  
This starts outputting the Y-axis offset data, and "OUTPUT" blinks in the lower right part of the screen. When the output operation ends, the "OUTPUT" indication disappears.  
To cancel the output, press horizontal soft key [CANCEL].

---

## 1.2.2 Inputting and Outputting Tool Offset / 2nd Geometry Tool Offset

---

With the lathe system, tool offset / 2nd geometry tool offset can be input and output using the ALL IO screen.

**NOTE**

"2nd Geometry Tool Offset" is an optional function.  
To use the "2nd Geometry Tool Offset", this option and "Tool geometry offset and Tool wear offset" are required. "Tool geometry offset and Tool wear offset" can be used, when bit 6 (NGW) of parameter No.8136 is 0.

---

**Inputting tool offset / 2nd geometry tool offset (for 8.4/10.4-inch display unit)**

---

**Procedure**

- 1 Press the continuous menu key  on the ALL IO screen several times until soft key [GEOM.2] is displayed.
- 2 Press soft key [GEOM.2].
- 3 Select EDIT mode.
- 4 Press soft key [(OPRT)].

- 5 Press soft key [N INPUT].
- 6 Set the name of the file that you want to input.  
Type a file name, and press soft key [F NAME].  
If the input file name is omitted, default input file name "SEC\_GEOM.TXT" is assumed.
- 7 Press soft key [EXEC].  
This starts inputting the 2nd geometry tool offset, and "INPUT" blinks in the lower right part of the screen. When the input operation ends, the "INPUT" indication disappears.  
To cancel the input, press soft key [CANCEL].

---

### Inputting tool offset / 2nd geometry tool offset (for 15-inch display unit)

---

#### Procedure

- 1 Press vertical soft key [NEXT PAGE] on the ALL IO screen several times until vertical soft key [2ND GEOM] is displayed.
- 2 Press vertical soft key [2ND GEOM].
- 3 Select EDIT mode.
- 4 Press horizontal soft key [N INPUT].
- 5 Set the name of the file that you want to input.  
Type a file name, and press soft key [F NAME].  
If the input file name is omitted, default input file name "SEC\_GEOM.TXT" is assumed.
- 6 Press horizontal soft key [EXEC].  
This starts inputting the 2nd geometry tool offset, and "INPUT" blinks in the lower right part of the screen. When the input operation ends, the "INPUT" indication disappears.  
To cancel the input, press horizontal soft key [CANCEL].

---

### Outputting tool offset / 2nd geometry tool offset (for 8.4/10.4-inch display unit)

---

#### Procedure

- 1 Press the continuous menu key  on the ALL IO screen several times until soft key [GEOM.2] is displayed.
- 2 Press soft key [GEOM.2].
- 3 Select EDIT mode.
- 4 Press soft key [(OPRT)].
- 5 Press soft key [F OUTPUT].
- 6 Set the file name to be output.  
Type a file name, and press soft key [F NAME].  
If the file name is omitted, default file name "SEC\_GEOM.TXT" is assumed.
- 7 Press soft key [EXEC].  
This starts outputting the 2nd geometry tool offset, and "OUTPUT" blinks in the lower right part of the screen. When the output operation ends, the "OUTPUT" indication disappears.  
To cancel the output, press soft key [CANCEL].

---

### Outputting tool offset / 2nd geometry tool offset (for 15-inch display unit)

---

#### Procedure

- 1 Press vertical soft key [NEXT PAGE] on the ALL IO screen several times until vertical soft key [2ND GEOM] is displayed.
- 2 Press vertical soft key [2ND GEOM].
- 3 Select EDIT mode.
- 4 Press horizontal soft key [F OUTPUT].
- 5 Set the file name to be output.  
Type a file name, and press soft key [F NAME].  
If the file name is omitted, default file name "SEC\_GEOM.TXT" is assumed.

- 6 Press soft key [EXEC].  
This starts outputting the 2nd geometry tool offset, and "OUTPUT" blinks in the lower right part of the screen. When the output operation ends, the "OUTPUT" indication disappears.  
To cancel the output, press soft key [CANCEL].

# 2 SETTING AND DISPLAYING DATA

Chapter 2, "SETTING AND DISPLAYING DATA", consists of the following sections:

|       |   |     |
|-------|---|-----|
| 2.1   | SCREENS DISPLAYED BY FUNCTION KEY  | 319 |
| 2.1.1 | Setting and Displaying the Tool Offset Value .....  | 319 |
| 2.1.2 | Direct Input of Tool Offset Value .....   | 324 |
| 2.1.3 | Direct Input of Tool Offset Value Measured B.....   | 327 |
| 2.1.4 | Counter Input of Offset value.....  | 329 |
| 2.1.5 | Setting the Workpiece Coordinate System Shift Value.....  | 330 |
| 2.1.6 | Setting Tool Offset / 2nd Geometry Tool Offset Values.....  | 334 |
| 2.1.7 | Setting the Y-Axis Offset.....  | 337 |
| 2.1.8 | Setting the 4th/5th Axis Offset.....  | 343 |
| 2.1.9 | Chuck and Tail Stock Barriers .....   | 348 |

## 2.1 SCREENS DISPLAYED BY FUNCTION KEY

Press function key  to display or set tool offset values and other data.

This section describes how to display or set the following data:

1. Tool offset value
2. Workpiece coordinate system shift value
3. Tool offset / 2nd geometry tool offset
4. Y-axis offset value
5. 4th/5th axis offset value
6. Chuck and tail stock barriers

### 2.1.1 Setting and Displaying the Tool Offset Value

Dedicated screens are provided for displaying and setting tool offset values and tool nose radius compensation values.

#### Setting and displaying the tool offset value and the tool nose radius compensation value (for 8.4/10.4-inch display unit)

##### Procedure

- 1 Press function key .
 

When using a multi-path system, select, in advance, a path for which a tool offset value is to be set, by using the path selection switch.
- 2 Press chapter selection soft key [OFFSET] or press function key  several times until the tool offset screen is displayed.
 

Different screens are displayed depending on whether tool geometry offset, wear offset, or neither is applied.

| OFFSET |       |       |       |   | 00123 N00000 |       |  |
|--------|-------|-------|-------|---|--------------|-------|--|
| NO.    | X     | Z     | R     | T | RELATIVE     |       |  |
| 001    | 0.000 | 0.000 | 0.000 | 0 | U            | 0.000 |  |
| 002    | 0.000 | 0.000 | 0.000 | 0 | W            | 0.000 |  |
| 003    | 0.000 | 0.000 | 0.000 | 0 | H            | 0.000 |  |
| 004    | 0.000 | 0.000 | 0.000 | 0 | V            | 0.000 |  |
| 005    | 0.000 | 0.000 | 0.000 | 0 | ABSOLUTE     |       |  |
| 006    | 0.000 | 0.000 | 0.000 | 0 | X            | 0.000 |  |
| 007    | 0.000 | 0.000 | 0.000 | 0 | Z            | 0.000 |  |
| 008    | 0.000 | 0.000 | 0.000 | 0 | C            | 0.000 |  |
| 009    | 0.000 | 0.000 | 0.000 | 0 | Y            | 0.000 |  |
| 010    | 0.000 | 0.000 | 0.000 | 0 | MACHINE      |       |  |
| 011    | 0.000 | 0.000 | 0.000 | 0 | X            | 0.000 |  |
| 012    | 0.000 | 0.000 | 0.000 | 0 | Z            | 0.000 |  |
| 013    | 0.000 | 0.000 | 0.000 | 0 | C            | 0.000 |  |
| 014    | 0.000 | 0.000 | 0.000 | 0 | Y            | 0.000 |  |
| 015    | 0.000 | 0.000 | 0.000 | 0 |              |       |  |
| 016    | 0.000 | 0.000 | 0.000 | 0 |              |       |  |
| 017    | 0.000 | 0.000 | 0.000 | 0 |              |       |  |

A>\_

MEM \*\*\*\*\* 12:00:00

< NO. SRH MEASUR INP. C. +INPUT INPUT ERASE F INPUT F OUTPUT WEAR

Fig. 2.1.1 (a) Without tool geometry/wear offset (10.4-inch display unit)

| OFFSET / GEOMETRY |       |       |       |   | 00123 N00000 |       |  |
|-------------------|-------|-------|-------|---|--------------|-------|--|
| NO.               | X     | Z     | R     | T | RELATIVE     |       |  |
| G 001             | 0.000 | 0.000 | 0.000 | 0 | U            | 0.000 |  |
| G 002             | 0.000 | 0.000 | 0.000 | 0 | W            | 0.000 |  |
| G 003             | 0.000 | 0.000 | 0.000 | 0 | H            | 0.000 |  |
| G 004             | 0.000 | 0.000 | 0.000 | 0 | V            | 0.000 |  |
| G 005             | 0.000 | 0.000 | 0.000 | 0 | ABSOLUTE     |       |  |
| G 006             | 0.000 | 0.000 | 0.000 | 0 | X            | 0.000 |  |
| G 007             | 0.000 | 0.000 | 0.000 | 0 | Z            | 0.000 |  |
| G 008             | 0.000 | 0.000 | 0.000 | 0 | C            | 0.000 |  |
| G 009             | 0.000 | 0.000 | 0.000 | 0 | Y            | 0.000 |  |
| G 010             | 0.000 | 0.000 | 0.000 | 0 | MACHINE      |       |  |
| G 011             | 0.000 | 0.000 | 0.000 | 0 | X            | 0.000 |  |
| G 012             | 0.000 | 0.000 | 0.000 | 0 | Z            | 0.000 |  |
| G 013             | 0.000 | 0.000 | 0.000 | 0 | C            | 0.000 |  |
| G 014             | 0.000 | 0.000 | 0.000 | 0 | Y            | 0.000 |  |
| G 015             | 0.000 | 0.000 | 0.000 | 0 |              |       |  |
| G 016             | 0.000 | 0.000 | 0.000 | 0 |              |       |  |
| G 017             | 0.000 | 0.000 | 0.000 | 0 |              |       |  |

A>\_

MEM \*\*\*\*\* 12:00:00

< NO. SRH MEASUR INP. C. +INPUT INPUT ERASE F INPUT F OUTPUT WEAR

Fig. 2.1.1 (b) With tool geometry offset (10.4-inch display unit)

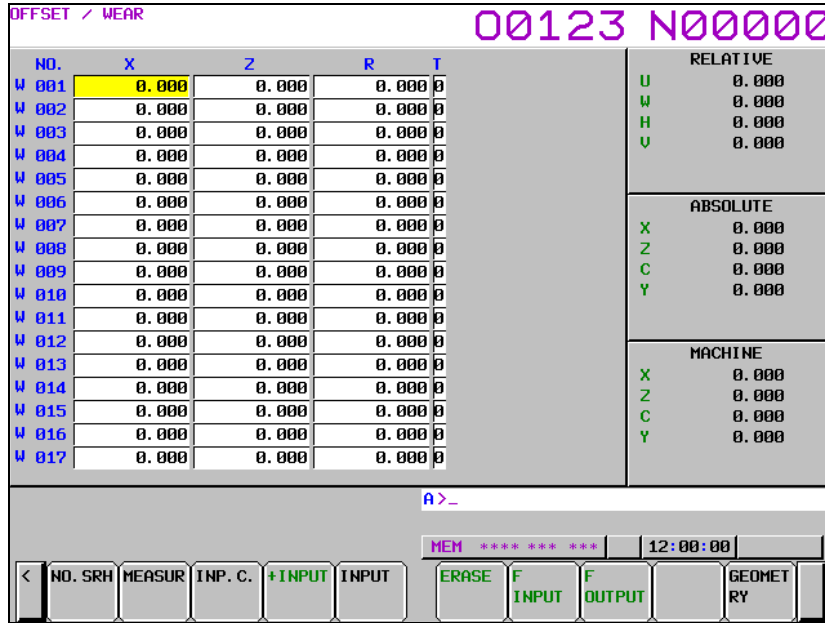



Fig. 2.1.1 (c) With tool wear offset (10.4-inch display unit)

- 3 Move the cursor to the offset value to be set or changed using page keys and cursor keys, or enter the offset number for the offset value to be set or changed and press soft key [NO.SRH].
- 4 To set a offset value, enter a value and press soft key [INPUT]. To change the offset value, enter a value to add to the current value (a negative value to reduce the current value) and press soft key [+INPUT].  
 T is the number of the imaginary tool nose.  
 T may be specified on the geometry offset screen or on the wear offset screen.

**Setting and displaying the tool offset value and the tool nose radius compensation value (for 15-inch display unit)**

**Procedure**

- 1 Press function key .  
 When using a multi-path system, select, in advance, a path for which a tool offset value is to be set, by using the path selection switch.
- 2 Press vertical soft key [OFFSET] or press function key  several times until the tool offset screen is displayed.  
 Different screens are displayed depending on whether tool geometry offset, wear offset, or neither is applied.

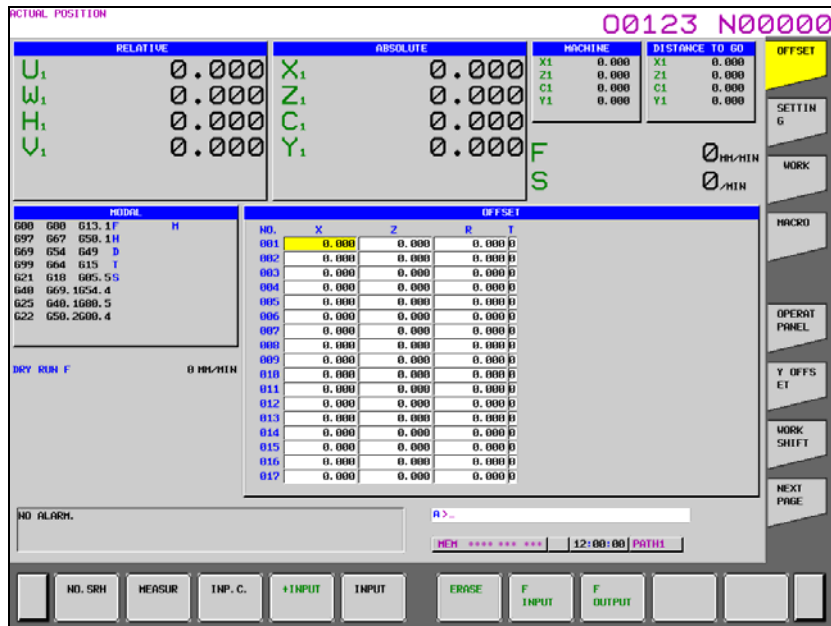

Fig. 2.1.1 (d) Without tool geometry/wear offset (15-inch display unit)

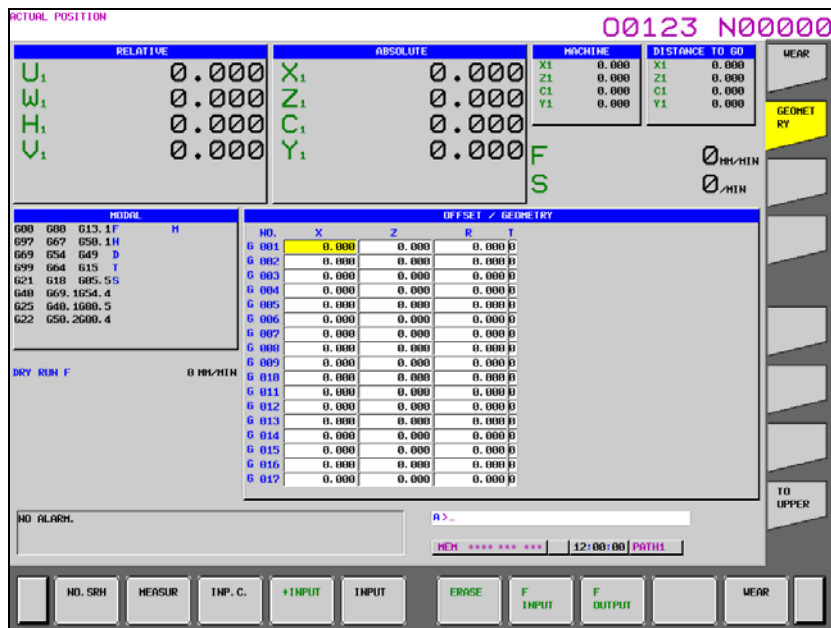

Fig. 2.1.1 (e) With tool geometry offset (15-inch display unit)



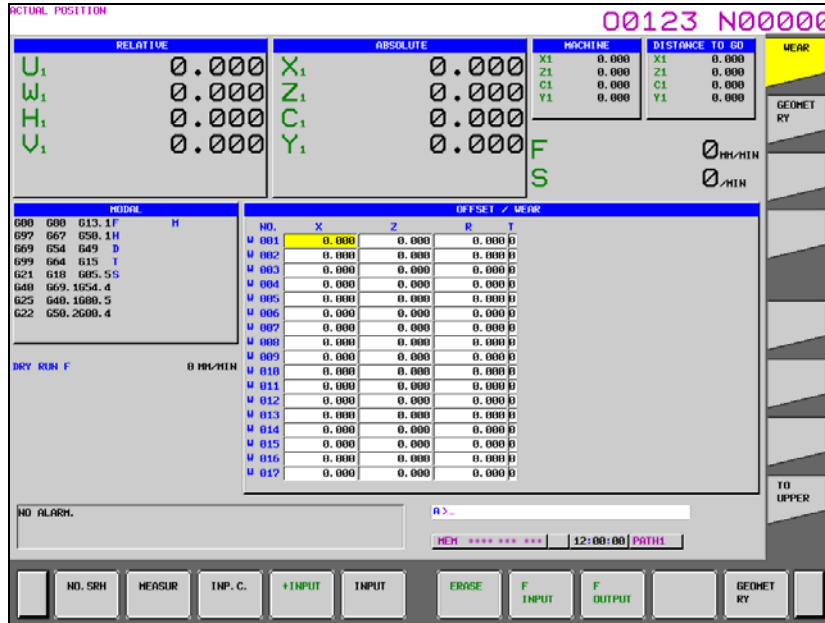

Fig. 2.1.1 (f) With tool wear offset (15-inch display unit)

- 3 Move the cursor to the offset value to be set or changed using page keys and cursor keys, or enter the offset number for the offset value to be set or changed and press horizontal soft key [NO.SRH].
- 4 To set a offset value, enter a value and press horizontal soft key [INPUT]. To change the offset value, enter a value to add to the current value (a negative value to reduce the current value) and press horizontal soft key [+INPUT].  
 T is the number of the imaginary tool nose.  
 T may be specified on the geometry offset screen or on the wear offset screen.

**Explanation**

- **Decimal point input**  
 A decimal point can be used when entering a offset value.
- **Other method**  
 An external input/output device can be used to input or output a tool offset value. See Chapter III-8 “Data Input/Output” in the OPERATOR’S MANUAL (Common to Lathe System/Machining Center System) (B-64604EN).  
 Tool length offset values can be set using the following functions described in subsequent subsections: direct input of tool offset value measured, direct input of tool offset value measured B, and counter input of offset value.
- **Number of tool offset values**  
 128 pairs are provided for tool offset. The number of groups can be optionally extended to 200. For the multi-path control, the above number of groups can be used for each path. Tool geometry offset or wear offset can be selected for each pair.
- **Disabling input of offset values**  
 In some cases, tool wear offset or tool geometry offset values cannot be input because of the settings in bits 0 (WOF) and 1 (GOF) of parameter No.3290. The input of tool offset values from the MDI can be inhibited for a specified range of offset numbers. The first offset number for which the input of a value is inhibited is set in parameter No. 3294. The number of offset numbers, starting from the specified first number, for which the input of a value is inhibited is set in parameter No. 3295.  
 Consecutive input values are set as follows:

- 1) When values are input for offset numbers, starting from one for which input is not inhibited to one for which input is inhibited, a warning is issued and values are set only for those offset numbers for which input is not inhibited.
- 2) When values are input for offset numbers, starting from one for which input is inhibited to one for which input is not inhibited, a warning is issued and no values are set.

**- Displaying radius and T**

The radius and T are not displayed if the tool nose radius compensation is not available (bit 7 (NCR) of parameter No.8136 is 1).

**- Changing offset values during automatic operation**

When offset values have been changed during automatic operation, bits 4 (LGT) and 6 (LWM) of parameter No.5002 can be used for specifying whether new offset values become valid in the next move command or in the next T code command.

Table 2.1.1 (a)

| LGT | LWM | When geometry tool offset values and wear tool offset values are separately specified | When geometry tool offset values and wear tool offset values are not separately specified |
|-----|-----|---|---|
| 0   | 0   | Become valid in the next T code block   | Become valid in the next T code block   |
| 1   | 0   | Become valid in the next T code block   | Become valid in the next T code block   |
| 0   | 1   | Become valid in the next T code block   | Become valid in the next move command   |
| 1   | 1   | Become valid in the next move command   | Become valid in the next move command   |

## 2.1.2 Direct Input of Tool Offset Value

To set the difference between the tool reference position used in programming (the nose of the standard tool, turret center, etc.) and the tool nose position of a tool actually used as an offset value.

### Direct input of tool offset value (for 8.4/10.4-inch display unit)

**Procedure**

**- Setting of Z axis offset value**

- 1 Cut surface A in manual mode with an actual tool.  
Suppose that a workpiece coordinate system has been set.

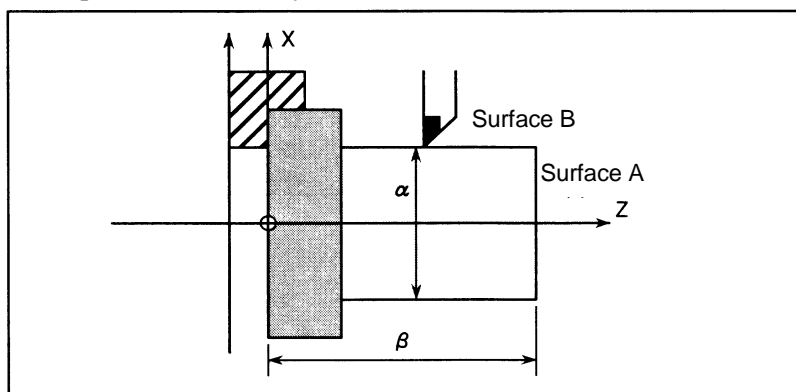

Fig. 2.1.2 (a)

- 2 Release the tool in X-axis direction only, without moving Z-axis and stop the spindle.

- 3 Measure distance  $\beta$  from the origin in the workpiece coordinate system to surface A.  
Set this value as the measured value along the Z-axis for the desired offset number, using the following procedure:

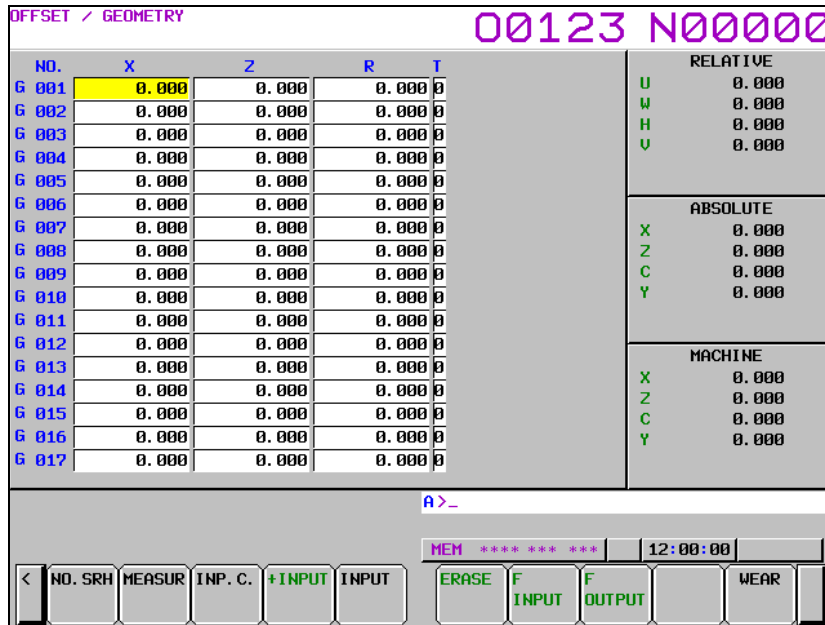



Fig. 2.1.2 (b) Tool offset screen (10.4-inch display unit)

- 3-1 Press the function key  or the soft key [OFFSET] to display the tool offset screen. If geometry offset values and wear offset values are separately specified, display the screen for either of them.
- 3-2 Move the cursor to the set offset number using cursor keys.
- 3-3 Press the address key  to be set.
- 3-4 Key in the measured value ( $\beta$ ).
- 3-5 Press the soft key [MEASURE].

The difference between measured value  $\beta$  and the coordinate is set as the offset value.

**- Setting of X axis offset value**

- 4 Cut surface B in manual mode.
- 5 Release the tool in the Z-axis direction without moving the X-axis and stop the spindle.
- 6 Measure the diameter  $\alpha$  of surface B.  
Set this value as the measured value along the X-axis for the desired offset number in the same way as when setting the value along the Z-axis.
- 7 Repeat above procedure the same time as the number of the necessary tools.

The offset value is automatically calculated and set.

For example, in case  $\alpha=69.0$  and the coordinate value of surface B is 70.0 in the Fig 2.1.2(a). If you set 69.0 [MEASURE] at offset No. 2, 1.0 is set as the X-axis offset value to offset No. 2.

**Direct input of tool offset value (for 15-inch display unit)**

**Procedure**

**- Setting of Z axis offset value**

- 1 Cut surface A in manual mode with an actual tool.  
Suppose that a workpiece coordinate system has been set.

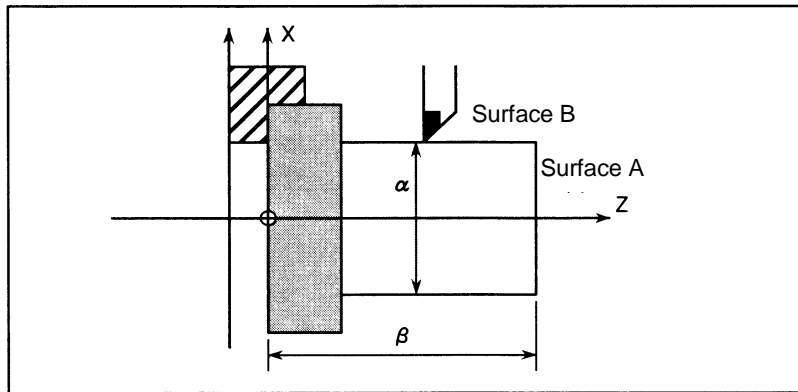

Fig. 2.1.2 (c)

- 2 Release the tool in X-axis direction only, without moving Z-axis and stop the spindle.
- 3 Measure distance  $\beta$  from the origin in the workpiece coordinate system to surface A. Set this value as the measured value along the Z-axis for the desired offset number, using the following procedure:

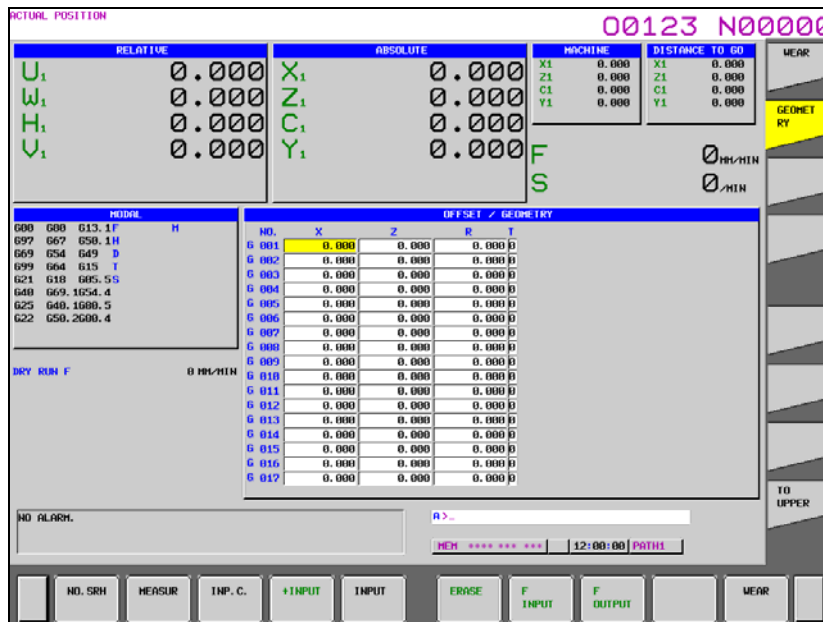



Fig. 2.1.2 (d) Tool offset screen (15-inch display unit)

- 3-1 Press the function key  or the vertical soft key [OFFSET] to display the tool offset screen. If geometry offset values and wear offset values are separately specified, display the screen for either of them.
- 3-2 Move the cursor to the set offset number using cursor keys.
- 3-3 Press the address key  to be set.
- 3-4 Key in the measured value ( $\beta$ ).
- 3-5 Press the horizontal soft key [MEASURE].  
The difference between measured value  $\beta$  and the coordinate is set as the offset value.

**- Setting of X axis offset value**

- 4 Cut surface B in manual mode.
- 5 Release the tool in the Z-axis direction without moving the X-axis and stop the spindle.
- 6 Measure the diameter  $\alpha$  of surface B.

Set this value as the measured value along the X-axis for the desired offset number in the same way as when setting the value along the Z-axis.

7 Repeat above procedure the same time as the number of the necessary tools.

The offset value is automatically calculated and set.

For example, in case  $\alpha=69.0$  and the coordinate value of surface B is 70.0 in the Fig 2.1.2(c). If you set 69.0 [MEASURE] at offset No. 2, 1.0 is set as the X-axis offset value to offset No. 2.

## Explanation

### - Offset values for a program created in diameter programming

Enter diameter values for the offset values for axes for which diameter programming is used.

### - Tool geometry offset value and tool wear offset value

If measured values are set on the tool geometry offset screen, all offset values become geometry offset values and all wear offset values are set to 0. If measured values are set on the tool wear offset screen, the differences between the measured offset values and the current wear offset values become the new offset values.

### - Release of both axes

When the record button is provided on the machine side, the tool can be released in the directions of the two axes by setting bit 2 (PRC) of parameter No. 5005 or using the position record signal PRC. For details on the position record signal PRC, refer to the manual issued by the machine tool builder.

## 2.1.3 Direct Input of Tool Offset Value Measured B

### Explanation

#### - Basic procedure to set tool offset value

To use the direct input of offset value measured B for 2 spindle lathe, first specify the spindle to be measured, using the spindle measurement selection signal S2TLS.

(1) Execute manual reference position return.

By executing manual reference position return, a machine coordinate system is established. The tool offset value is computed on the machine coordinate system.

(2) Select manual handle mode or manual continuous feed mode and set the tool offset write mode selection signal GOQSM to "1". The screen is automatically changed to the tool offset screen (geometry), and the "OFST" indicator starts blinking in the status indication area at the bottom of the screen, which indicates that the tool offset writing mode is ready. When the direct input of offset value measured B for 2 spindle lathe is in use, the spindle measurement selection signal S1MES or S2MES, whichever is applicable, becomes "1".



### CAUTION

After this, it is impossible to switch the spindle measurement selection signal S2TLS until the tool offset write mode selection signal GOQSM becomes "0".

(3) Select a tool to be measured.

(4) When the cursor does not focus on the tool offset number desired to be set, move the cursor to the desired offset number using the page key and cursor key.

The cursor can also be focused on the tool offset number desired to be set automatically by the tool offset number selection signals OFN0 to OFN5 and OFN6 to OFN9 (when bit 5 (QNI) of parameter No. 5005=1).

In this case, the position of the cursor cannot be changed on the tool offset screen using page keys or cursor keys.

(5) Near the tool to the sensor by manual operation.

(6) Place the tool edge to a contacting surface of the sensor by manual handle feed.

Bring the tool edge in contact with the sensor. This causes the tool offset writing signals to input to be CNC.

The following tool offset write signals are set up according to the setting of the bit 3 (TS1) of parameter No. 5004.

When the parameter is 0: +MIT1, -MIT1, +MIT2, -MIT2

When the parameter is 1: +MIT1 only

If the tool offset writing signal is set to "1":

- i) The axis is interlocked in this direction and its feed is stopped.
  - ii) The tool offset value extracted by the tool offset memory (tool geometry offset value) which corresponds to the offset number is indicated by the cursor.
- (7) For both X-axis and Z-axis, their offset values are set by operations (5) and (6).  
 (8) Repeat operations (3) to (7) for all necessary tools.  
 (9) Set the tool offset writing mode signal GOQSM to "0".

The writing mode is canceled and the blinking "OFST" indicator light goes off.

When the direct input of offset value measured B for 2 spindle lathe is in use, the spindle measurement selection signal S1MES or S2MES for the spindle being measured becomes "0".

### - Basic procedure to set workpiece coordinate shift value

To use the direct input of offset value measured B for 2 spindle lathe, first specify the spindle to be measured, using the spindle measurement selection signal S2TLS.

- (1) Set the tool geometry offset values of each tool in advance.
- (2) Execute manual reference position return.  
 By executing manual reference position return, the machine coordinate system is established.  
 The workpiece coordinate system shift amount is computed based on the machine coordinate system of the tool.
- (3) Set the workpiece coordinate system shift value writing mode selection signal WOQSM to "1".  
 The screen automatically switches to the workpiece shifting screen, the "WFST" indicator starts blinking at the status indicator area in the bottom of the screen, which indicates that the workpiece coordinate system shift value writing mode is ready.  
 When the direct input of offset value measured B for 2 spindle lathe is in use, the workpiece coordinate system screen is selected, and the S1MES or S2MES (spindle measurement select) signal, whichever is applicable, becomes "1".

### CAUTION

After this, it is impossible to switch the spindle measurement selection signal S2TLS until the workpiece coordinate system shift value write mode selection signal WOQSM becomes "0".

- (4) Select a tool to be measured.
- (5) Check tool offset numbers.  
 The tool offset number corresponding to the tool required for measurement, shall be set in the parameter No.5020 in advance.  
 The tool offset number can also be set automatically by setting the tool offset number selection signals OFN0 to OFN5 and OFN6 to OFN9 (with bit 5 (QNI) of parameter No. 5005=1).
- (6) Manually approach the tool to an end face of the workpiece.
- (7) Place the tool edge to the end face (sensor) of the workpiece using manual handle feed.  
 When the tool edge contacts the end face of the workpiece, input the workpiece coordinate system shift value write signal WOSET.  
 The workpiece coordinate system shift value on the Z-axis is automatically set.
- (8) Release the tool.
- (9) Set the workpiece coordinate system shift value write mode selection signal WOQSM to "0".  
 The writing mode is canceled and the blinking "WSFT" indicator light goes off.  
 When the direct input of offset value measured B for 2 spindle lathe is in use, the S1MES or S2MES (spindle measurement select) signal, whichever is applicable, becomes "0".

## 2.1.4 Counter Input of Offset value

By moving the tool until it reaches the desired reference position, the corresponding tool offset value can be set.

### Counter input of offset value (for 8.4/10.4-inch display unit)

#### Procedure

- 1 Manually move the reference tool to the reference position.
- 2 Reset the relative coordinates along the axes to 0.
- 3 Move the tool for which offset values are to be set to the reference position.
- 4 Select the tool offset screen. Move the cursor to the offset value to be set using cursor keys.

| OFFSET |       |       |       |   | 00123 N00000 |       |  |
|--------|-------|-------|-------|---|--------------|-------|--|
| NO.    | X     | Z     | R     | T | RELATIVE     |       |  |
| 001    | 0.000 | 0.000 | 0.000 | 0 | U            | 0.000 |  |
| 002    | 0.000 | 0.000 | 0.000 | 0 | W            | 0.000 |  |
| 003    | 0.000 | 0.000 | 0.000 | 0 | H            | 0.000 |  |
| 004    | 0.000 | 0.000 | 0.000 | 0 | V            | 0.000 |  |
| 005    | 0.000 | 0.000 | 0.000 | 0 |              |       |  |
| 006    | 0.000 | 0.000 | 0.000 | 0 |              |       |  |
| 007    | 0.000 | 0.000 | 0.000 | 0 |              |       |  |
| 008    | 0.000 | 0.000 | 0.000 | 0 | ABSOLUTE     |       |  |
| 009    | 0.000 | 0.000 | 0.000 | 0 | X            | 0.000 |  |
| 010    | 0.000 | 0.000 | 0.000 | 0 | Z            | 0.000 |  |
| 011    | 0.000 | 0.000 | 0.000 | 0 | C            | 0.000 |  |
| 012    | 0.000 | 0.000 | 0.000 | 0 | Y            | 0.000 |  |
| 013    | 0.000 | 0.000 | 0.000 | 0 |              |       |  |
| 014    | 0.000 | 0.000 | 0.000 | 0 | MACHINE      |       |  |
| 015    | 0.000 | 0.000 | 0.000 | 0 | X            | 0.000 |  |
| 016    | 0.000 | 0.000 | 0.000 | 0 | Z            | 0.000 |  |
| 017    | 0.000 | 0.000 | 0.000 | 0 | C            | 0.000 |  |
|        |       |       |       |   | Y            | 0.000 |  |

A>>X\_

|   |         |        |         |           |          |       |         |          |  |  |
|---|---------|--------|---------|-----------|----------|-------|---------|----------|--|--|
|   |         |        |         | MEM ***** | 12:00:00 |       |         |          |  |  |
| < | NO. SRH | MEASUR | INP. C. | +INPUT    | INPUT    | ERASE | F INPUT | F OUTPUT |  |  |

Fig. 2.1.4 (a) Tool offset screen (10.4-inch display unit)

- 5 Press address key  (or ) and the soft key [INP.C.].

### Counter input of offset value (for 15-inch display unit)

#### Procedure

- 1 Manually move the reference tool to the reference position.
- 2 Reset the relative coordinates along the axes to 0.
- 3 Move the tool for which offset values are to be set to the reference position.
- 4 Select the tool offset screen. Move the cursor to the offset value to be set using cursor keys.

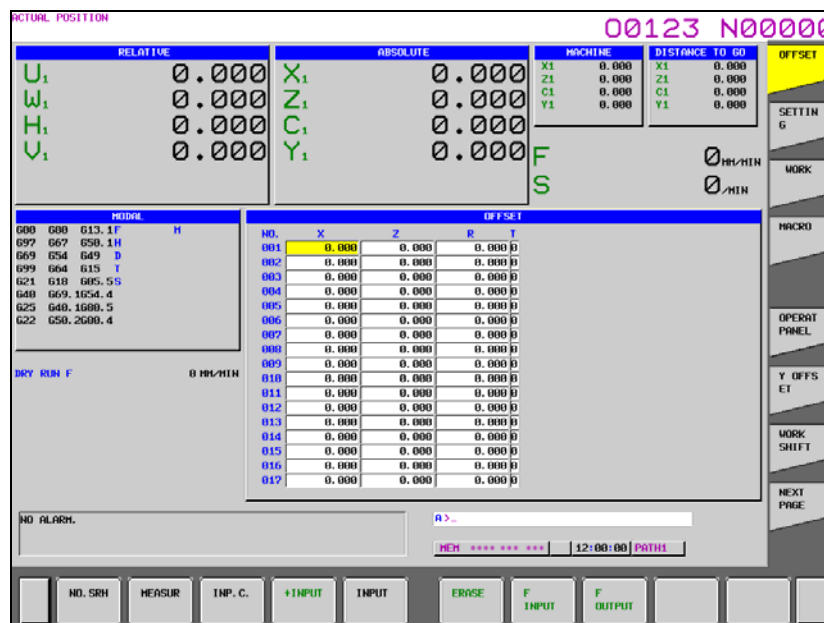

Fig. 2.1.4 (b) Tool offset screen (15-inch display unit)

- 5 Press address key  $\boxed{X}$  (or  $\boxed{Z}$ ) and the horizontal soft key [INP.C.].

## Explanation

### - Geometry offset and wear offset

When the above operations are performed on the tool geometry offset screen, tool geometry offset values are input and tool wear offset values do not change.

When the above operations are performed on the tool wear offset screen, tool wear offset values are input and tool geometry offset values do not change.

## 2.1.5 Setting the Workpiece Coordinate System Shift Value

The set coordinate system can be shifted when the coordinate system which has been set by a G50 command (or G92 command for G code system B or C) or automatic coordinate system setting is different from the workpiece coordinate system assumed at programming.

When a lathe system is used, the workpiece coordinate system shift screen is displayed.

### Setting the workpiece coordinate system shifting amount (for 8.4/10.4-inch display unit)

#### Procedure

- 1 Press function key  $\boxed{\text{W.SFT}}$ .
- 2 Press the continuous menu key  $\boxed{\text{▶}}$  several times until the screen with soft key [W.SHFT] is displayed.



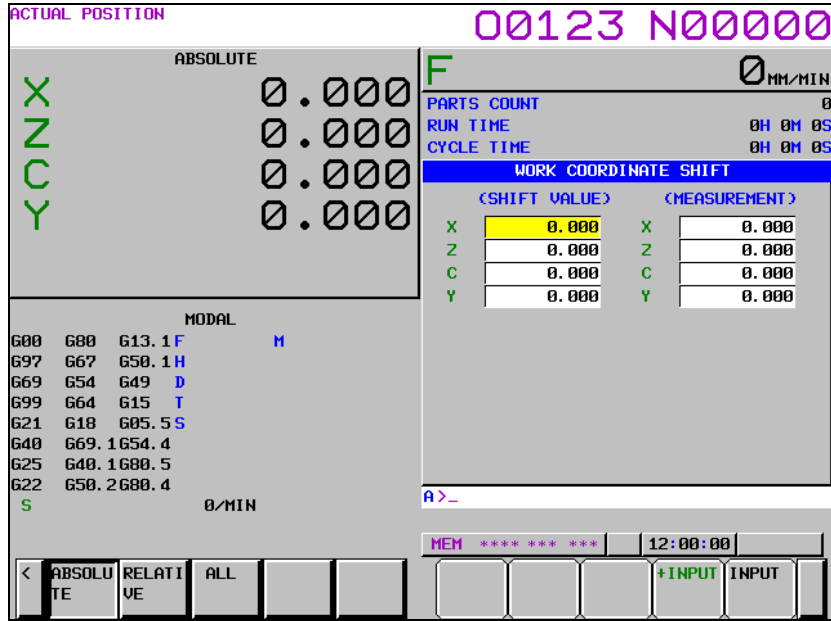

Fig. 2.1.5 (a) Workpiece coordinate system shift screen (10.4-inch display unit)

- 3 Press soft key [W.SHFT].
- 4 Move the cursor using cursor keys to the axis along which the coordinate system is to be shifted.
- 5 Enter the shift value and press soft key [INPUT].

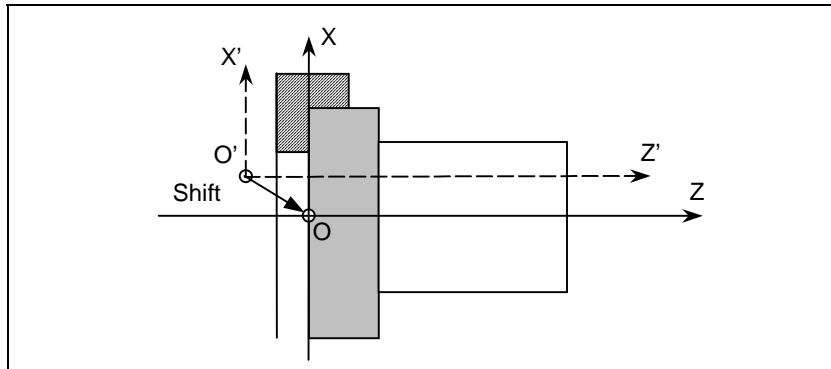



Fig. 2.1.5 (b)

**Setting the workpiece coordinate system shifting amount (for 15-inch display unit)**

- 1 Press function key .
- 2 Press vertical soft key [NEXT PAGE] several times until vertical soft key [WORK SHIFT] is displayed.

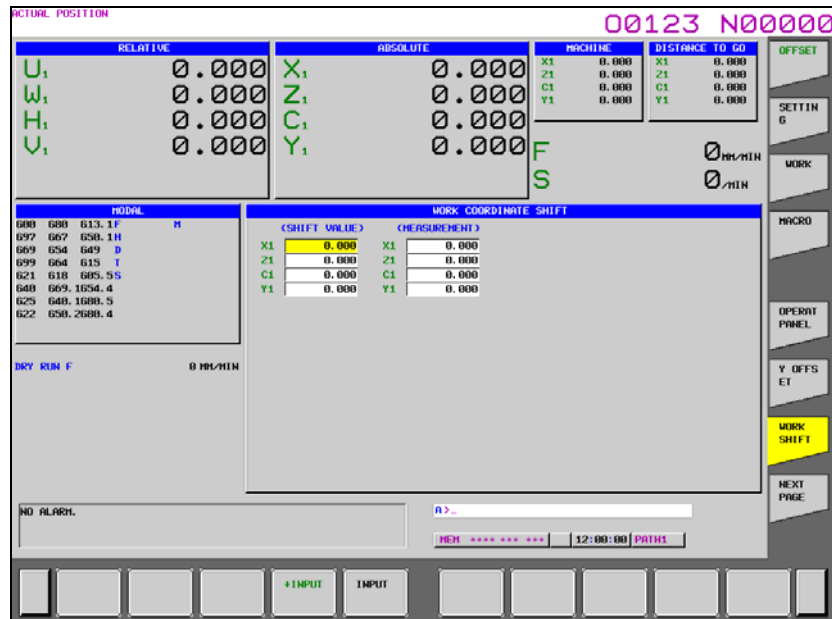

Fig. 2.1.5 (c) Workpiece coordinate system shift screen (15-inch display unit)

- 3 Press vertical soft key [WORK SHIFT].
- 4 Move the cursor using cursor keys to the axis along which the coordinate system is to be shifted.
- 5 Enter the shift value and press horizontal soft key [INPUT].

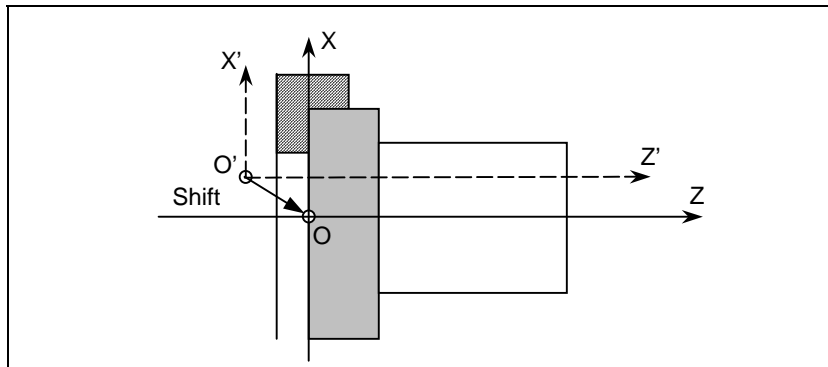

Fig. 2.1.5 (d)

### Direct input of coordinate system shift

If the tool position assumed at programming is inputted when the coordinate system actually set is different from the workpiece coordinate system assumed at programming, shift length of the coordinate system actually set and the workpiece coordinate system assumed at programming is set in the workpiece coordinate system shift value.

The procedure leading up to inputting coordinate system position depend on the setting made for bit 2 (PRC) of parameter No.5005.

The procedure in which the coordinate system position of workpiece end face is specified is as follows.

#### When bit 2 (PRC) of parameter No.5005 is set to 0

- 1 Cut the workpiece end face tentatively.
- 2 Display the workpiece coordinate system shift screen with touching tool to the workpiece end face.
- 3 Move the cursor to Z axis of MEASUREMENT.
- 4 Input the workpiece end face position on workpiece coordinate system assumed at programming and press soft key [INPUT].

**When bit 2 (PRC) of parameter No.5005 is set to 1**

- 1 Cut the workpiece end face tentatively.
- 2 Set the position record signal PRC to "1" with touching tool to the workpiece end face. (Refer to the appropriate manual provided by the machine tool builder for the actual operations.)
- 3 Remove a tool from the workpiece end face.
- 4 Display the workpiece coordinate system shift screen.
- 5 Move the cursor to Z axis of MEASUREMENT.
- 6 Input the workpiece end face position on workpiece coordinate system assumed at programming and press soft key [INPUT].

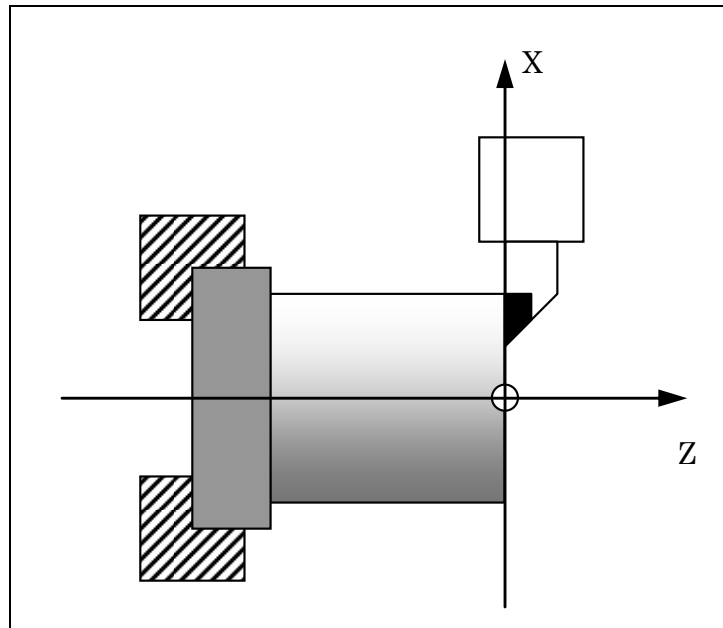

Fig.2.1.5 (e) Direct input of coordinate system shift

**Explanation****- When shift values become valid**

Shift values become valid immediately after they are set.

**- Shift values and coordinate system setting command**

Setting a command (G50 or G92) for setting a coordinate system disables the set shift values.

Example)

When G50 X100.0 Z80.0; is specified, the coordinate system is set so that the current tool reference position is X+100.0, Z+80.0 regardless of the shift values.

**- Shift values and coordinate system setting**

If the automatic coordinate system setting is performed by manual reference position return after shift amount setting, the coordinate system is shifted instantly.

**- Diameter or radius value**

Whether the shift amount on the X-axis is diameter or radius value depends on that specified in program.

**- Position record signal**

When bit 2 (PRC) of parameter No. 5005 is 1, the absolute coordinates when the position record signal PRC is "1" are recorded for calculation of the shift amount.

**Example**

When the actual position of the reference point is X=121.0 (diameter), Z=69.0 with respect to the workpiece origin but it should be X=120.0, Z=70.0, set the following shift values:

X=1.0, Z=-1.0

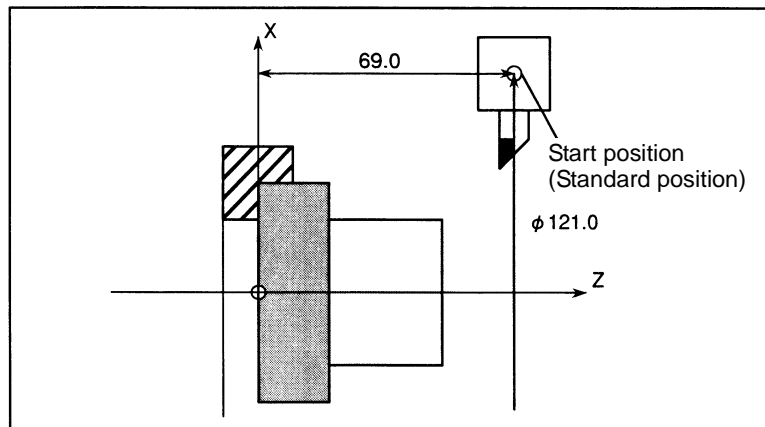

Fig. 2.1.5 (f)

## 2.1.6 Setting Tool Offset / 2nd Geometry Tool Offset Values

To compensate for a difference in tool attachment position or selection position, second geometry tool offset can be applied in addition to tool offset. As second geometry tool offset values, X-axis, Y-axis, and Z-axis offset values can be set.





**NOTE**

"2nd Geometry Tool Offset" is an optional function.

To use the "2nd Geometry Tool Offset", this option and "Tool geometry offset and Tool wear offset" are required. "Tool geometry offset and Tool wear offset" can be used, when bit 6 (NGW) of parameter No.8136 is 0.

### Procedure for displaying and setting second geometry tool offset values (for 8.4/10.4-inch display unit)

**Procedure**

- 1 Press function key .
- 2 Press the continuous menu key  several times until the screen with soft key [2ND GEOM] is displayed.
- 3 Press the soft key [2ND GEOM]. The tool offset/second geometry tool offset screen is displayed. When displaying data other than the data of the second geometry tool offset number currently displayed, press the page key  or  to display the screen for a desired second geometry tool offset number.

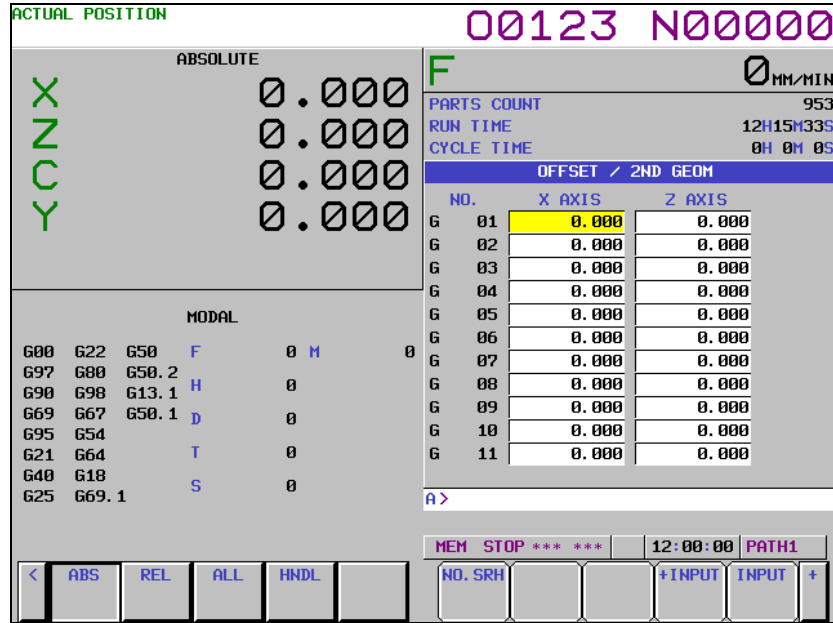

Fig. 2.1.6 (a) Tool offset/second geometry tool offset screen (10.4-inch display unit)

- 3-1 If one screen cannot fully display the second geometry tool offset values of the Y-axis, press the soft key [SWITCH] to switch the screen display.

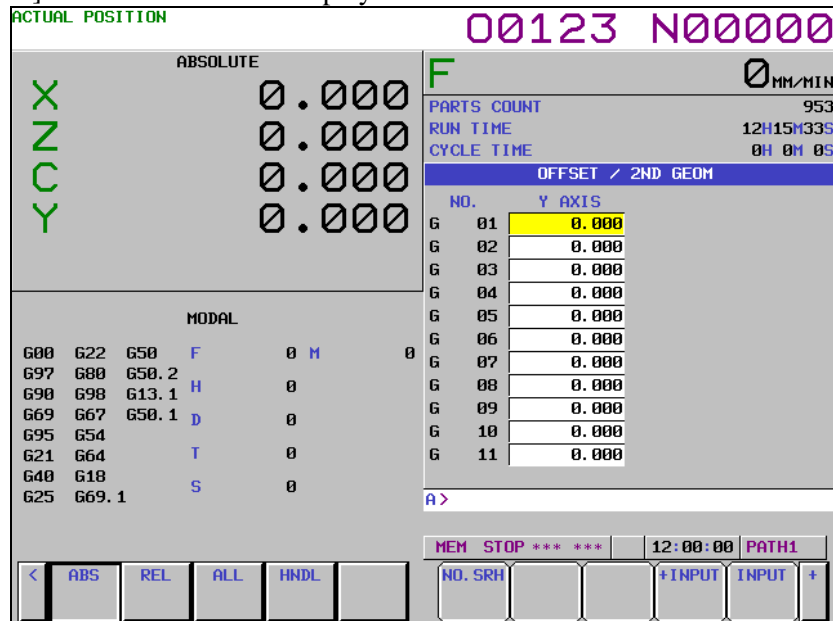





Fig. 2.1.6 (b) Tool offset/second geometry tool offset screen (after switching) (10.4-inch display unit)

- 4 By using one of the methods described below, move the cursor to the second geometry tool offset value of a desired second geometry tool offset number.
  - By using the page keys and cursor keys, move the cursor to the desired offset value position.
  - Key in the desired offset number then press soft key [NO.SRH].
- 5 Input a desired second geometry tool offset value then press the  key or soft key [INPUT].  
The input second geometry tool offset value is set. When an additional offset to the second geometry tool offset value currently displayed is input, press soft key [+INPUT]. In this case, the result of addition is set as the second geometry tool offset value.
- 6 Repeat steps 4 and 5 to set all parameters to be modified.

## Procedure for displaying and setting second geometry tool offset values (for 15-inch display unit)

- 1 Press function key .
- 2 Press vertical soft key [NEXT PAGE] several times until vertical soft key [2ND GEOM] is displayed.
- 3 Press the vertical soft key [2ND GEOM]. The tool offset/second geometry tool offset screen is displayed. When displaying data other than the data of the second geometry tool offset number currently displayed, press the page key  or  to display the screen for a desired second geometry tool offset number.

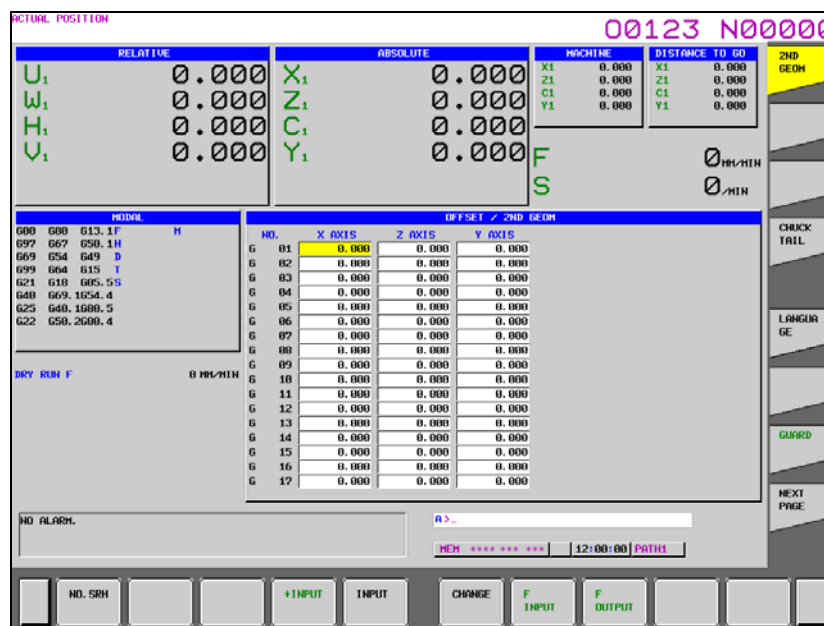



Fig. 2.1.6 (c) Tool offset/second geometry tool offset screen (15-inch display unit)

- 4 By using one of the methods described below, move the cursor to the second geometry tool offset value of a desired second geometry tool offset number.
  - By using the page keys and cursor keys, move the cursor to the desired offset value position.
  - Key in the desired offset number then press horizontal soft key [NO.SRH].
- 5 Input a desired second geometry tool offset value then press the  key or horizontal soft key [INPUT]. The input second geometry tool offset value is set. When an additional offset to the second geometry tool offset value currently displayed is input, press soft key [+INPUT]. In this case, the result of addition is set as the second geometry tool offset value.
- 6 Repeat steps 4 and 5 to set all offset value to be modified.

## Explanation

### - Input of a second geometry tool offset value

The value input in the key input buffer is set as the second geometry tool offset value where the cursor is currently placed.

### - +Input of a second geometry tool offset value

The value input in the key input buffer is added to the second geometry tool offset value where the cursor is currently placed.

**- Number search for a second geometry tool offset value**

The value input in the key input buffer is used as a second geometry tool offset number to move the cursor to the corresponding position.

**Limitation**

**- Setting of a second geometry tool offset value**

The setting of a second geometry tool offset value is valid only when bit 5 (GO2) of parameter No. 3290 is set to 1.

**2.1.7 Setting the Y-Axis Offset**



The Y-axis offset corresponding to each tool offset number is displayed, and can to set it.

When the tool geometry offset and tool wear offset functions are enabled and bit 4 (YGW) of parameter No. 11349 is set to 0 (operation 1), the display can be switched between the tool geometry and wear offset screens using soft key [CHANGE]. When these functions are enabled and bit 4 (YGW) of parameter No. 11349 is set to 1 (operation 2), the display can be switched between the tool geometry and wear offset screens using soft keys [WEAR] and [GEOMETRY].

**NOTE**  
The Y-axis offset is available, when bit 1 (YOF) of parameter No.8132 is 1.

**Operation 1**

**Procedure for setting the tool offset value of the Y axis (for 8.4/10.4-inch display unit)**

- 1 Press function key .
- 2 Press the continuous menu key  several times until the screen with soft key [Y OFFSET] is displayed.
- 3 Press soft key [Y OFFSET]. The Y-axis offset screen is displayed.

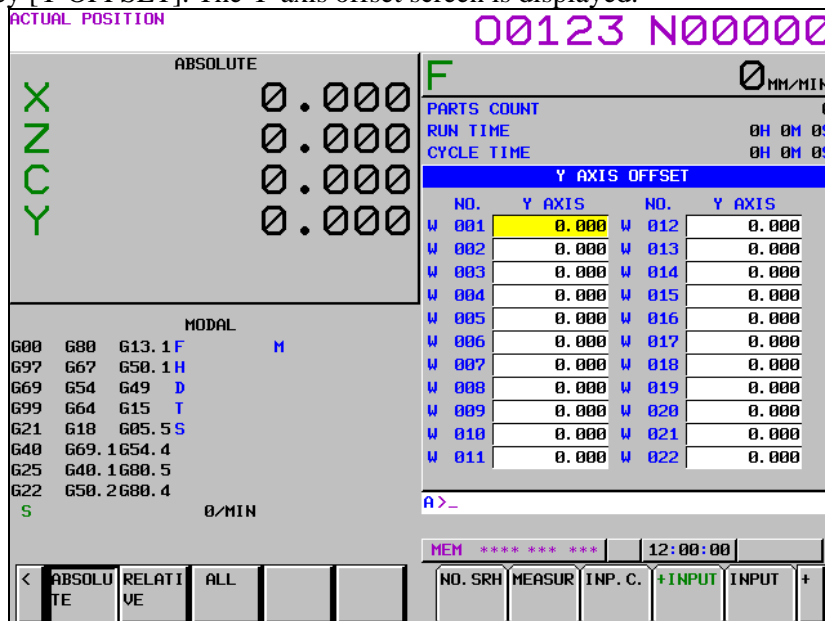



Fig. 2.1.7 (a) Y-axis offset screen (10.4-inch display unit)

- 3-1 When the tool geometry offset and wear offset functions are enabled, press soft key [(OPRT)] and continuous menu key . Soft key [CHANGE] appears. Press soft key [CHANGE].

Y-axis tool geometry offset data is displayed. Press soft key [CHANGE] again. The display changes to the tool wear offset screen.

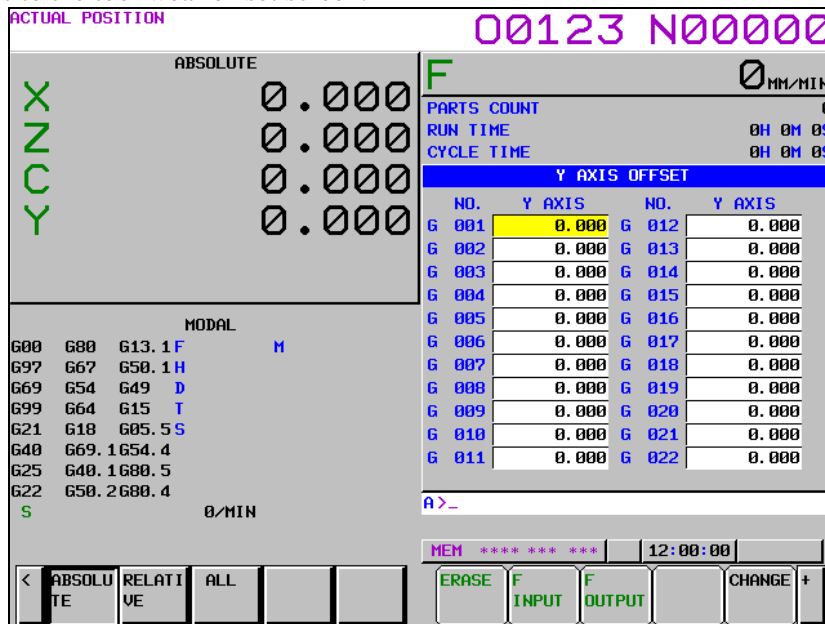

Fig. 2.1.7 (b) Y-axis offset screen (tool geometry) (10.4-inch display unit)

- 4 Position the cursor at the offset number to be changed by using either of the following methods:
  - Move the cursor to the offset number to be changed using page keys and cursor keys.
  - Type the offset number and press soft key [NO.SRH].
- 5 Enter the offset value.
- 6 Press soft key [INPUT]. The offset value is set and displayed.

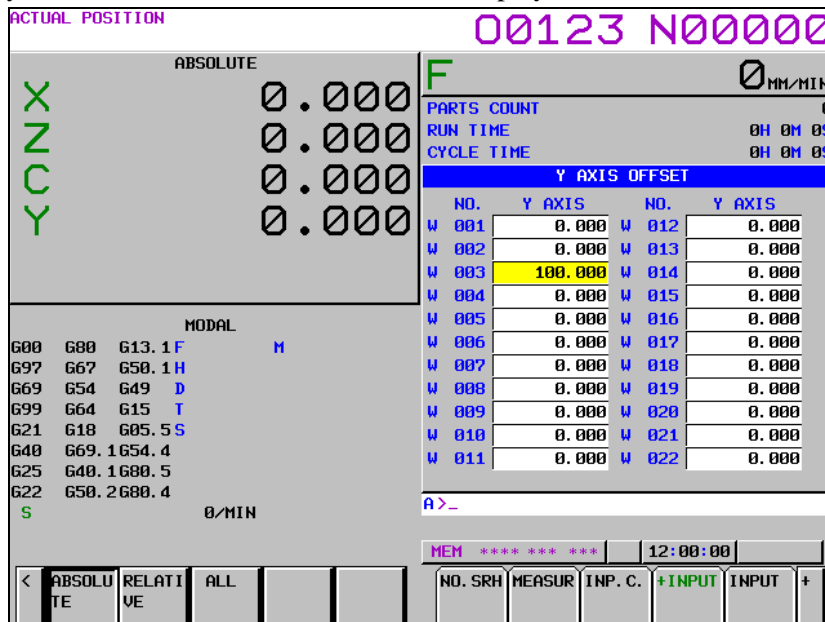



Fig. 2.1.7 (c) Y-axis offset screen (input) (10.4-inch display unit)

**Procedure for setting the tool offset value of the Y axis (for 15-inch display unit)**

- 1 Press function key .
- 2 Press vertical soft key [NEXT PAGE] several times until vertical soft key [Y OFFSET] is displayed.
- 3 Press vertical soft key [Y OFFSET]. The Y-axis offset screen is displayed.



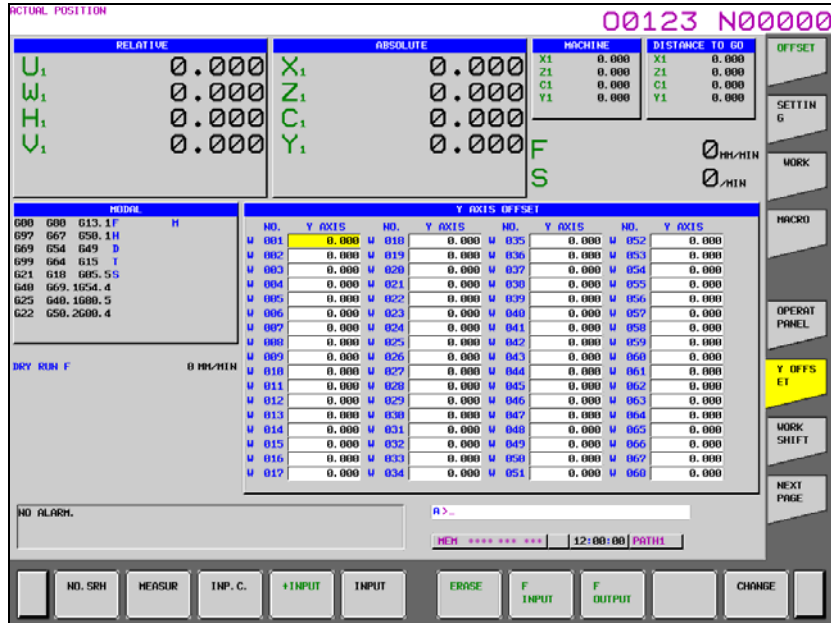

Fig. 2.1.7 (d) Y-axis offset screen (15-inch display unit)

3-1 When horizontal soft key [CHANGE] is pressed, Y-axis tool geometry offset data is displayed. Press the horizontal soft key [CHANGE] again to switch the screen display to the display of tool wear offset data.

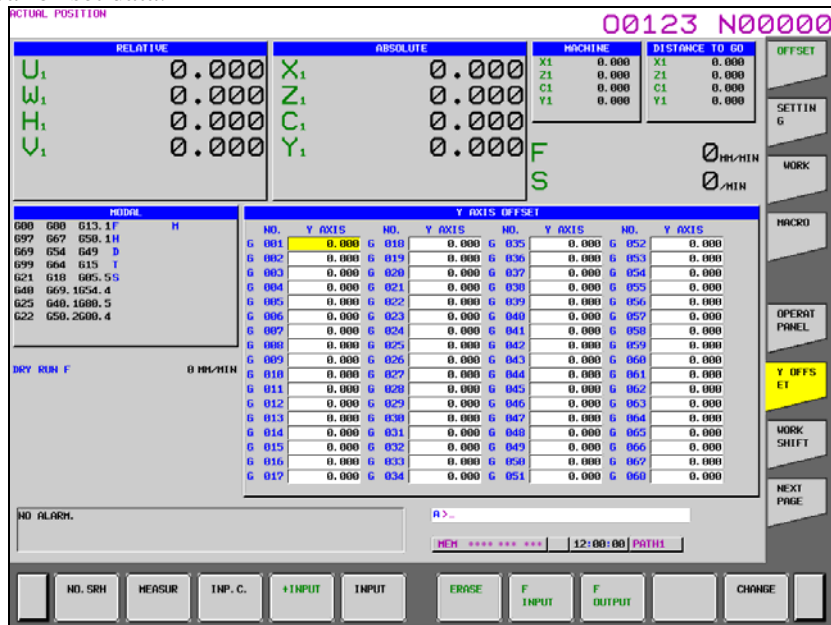

Fig. 2.1.7 (e) Y-axis offset screen (tool geometry)(15-inch display unit)

- 4 Position the cursor at the offset number to be changed by using either of the following methods:
  - Move the cursor to the offset number to be changed using page keys and cursor keys.
  - Type the offset number and press horizontal soft key [NO.SRH].
- 5 Enter the offset value.
- 6 Press horizontal soft key [INPUT]. The offset value is set and displayed.

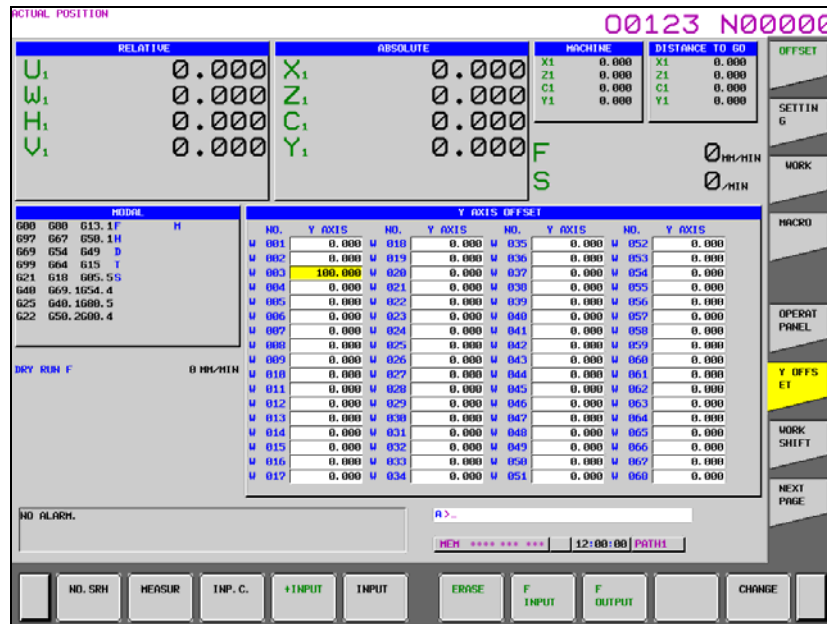



Fig. 2.1.7 (f) Y-axis offset screen (input)(15-inch display unit)

### Operation 2

When the tool geometry offset and wear offset functions are enabled and bit 4 (YGW) of parameter No. 11349 is set to 1, the display can be switched between the tool geometry and wear offset screens using soft keys [WEAR] and [GEOMETRY]. Vertical soft keys [WEAR] and [GEOMETRY] can also be used to switch the display between these screens.

### Procedure for setting the tool offset value of the Y axis (for 8.4/10.4-inch display unit)

- 1 Press function key .
- 2 Press the continuous menu key  several times until the screen with soft key [Y OFFSET] is displayed.
- 3 Press soft key [Y OFFSET]. The Y-axis offset screen is displayed.

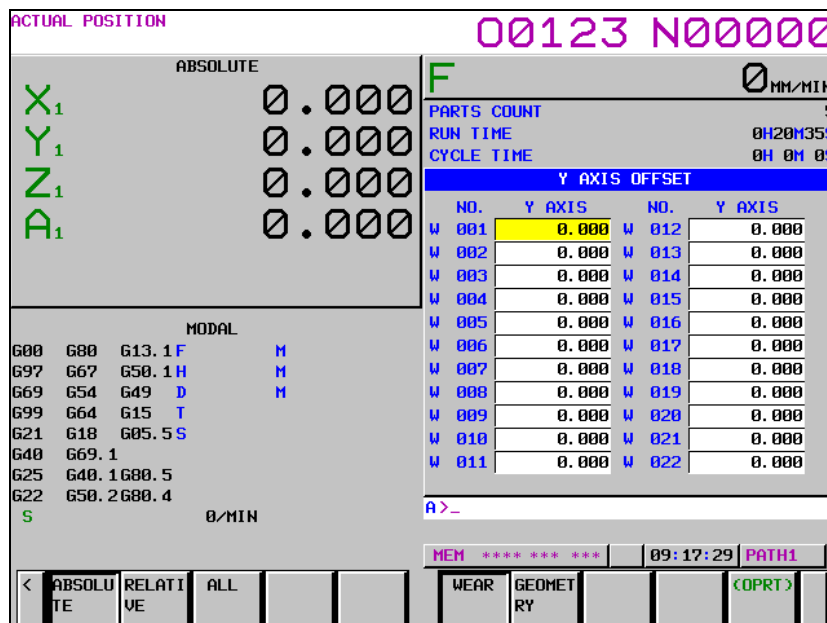

Fig. 2.1.7 (g) Y-axis offset screen (wear) (10.4-inch display unit)

- 3.1 Press soft key [(OPRT)] and continuous menu key . Soft key [GEOMETRY] appears. Press soft key [GEOMETRY] to display tool geometry offset data. Press soft key [WEAR] to display tool wear offset data.

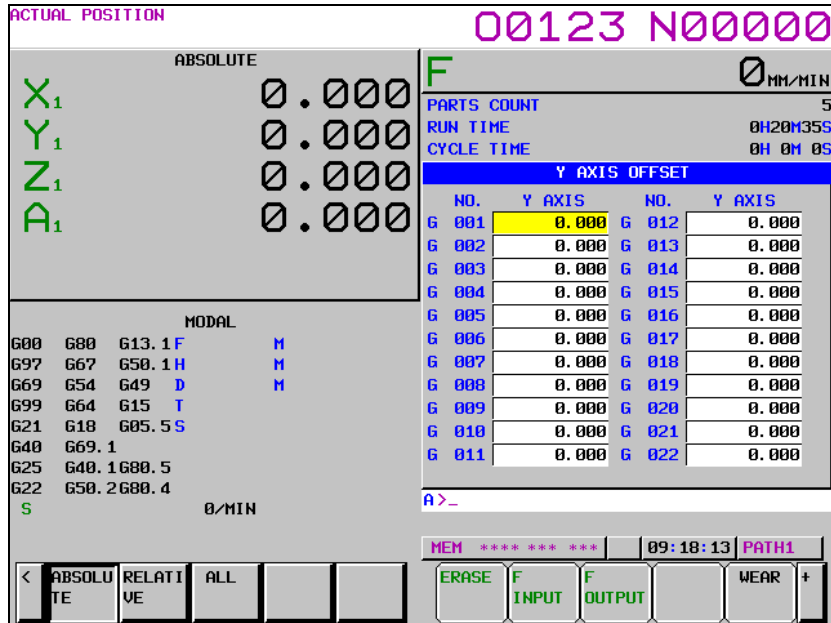

Fig. 2.1.7 (h) Y-axis offset screen (tool geometry) (10.4-inch display unit)

- 4 Position the cursor at the offset number to be changed by using either of the following methods:
  - Move the cursor to the offset number to be changed using page keys and cursor keys.
  - Type the offset number and press soft key [NO.SRH].
- 5 Enter the offset value.
- 6 Press soft key [INPUT]. The offset value is set and displayed.

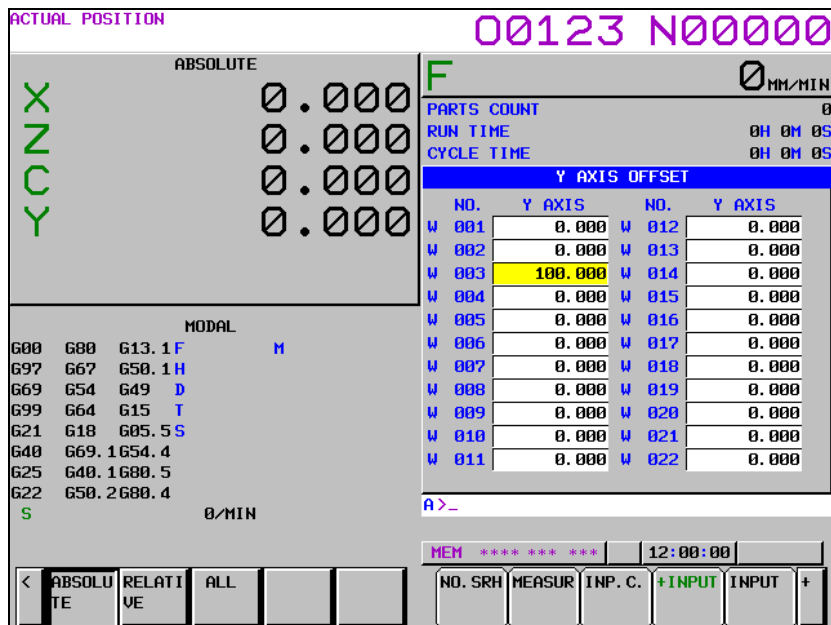



Fig. 2.1.7 (i) Y-axis offset screen (input) (10.4-inch display unit)

**Procedure for setting the tool offset value of the Y axis (for 15-inch display unit)**

- 1 Press function key .
- 2 Press vertical soft key [NEXT PAGE] several times until vertical soft key [Y OFFSET] is displayed.
- 3 Press vertical soft key [Y OFFSET]. The Y-axis offset screen is displayed.  
Press vertical soft key [WEAR] to display tool wear offset data. Press vertical soft key [GEOMETRY] to display tool geometry offset data.

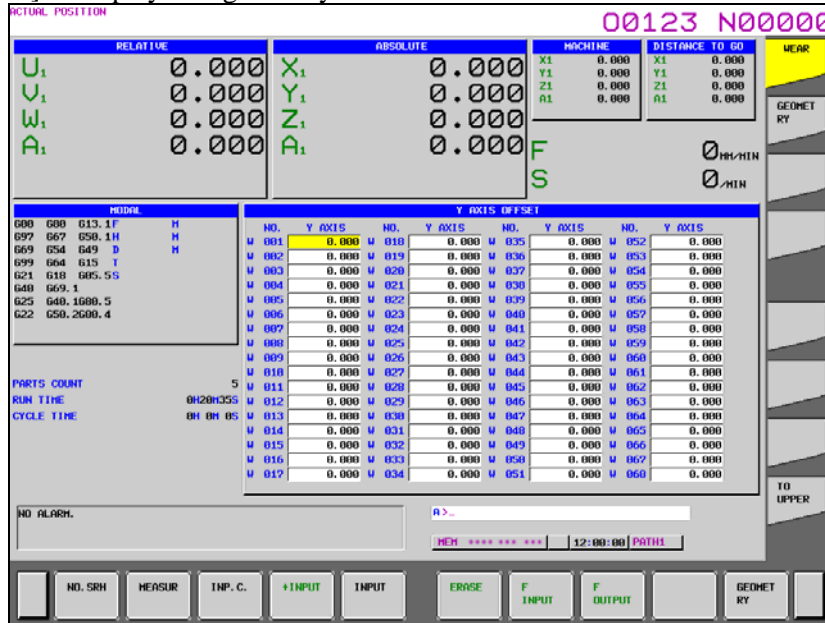

Fig. 2.1.7 (j) Y-axis offset screen (wear) (15-inch display unit)

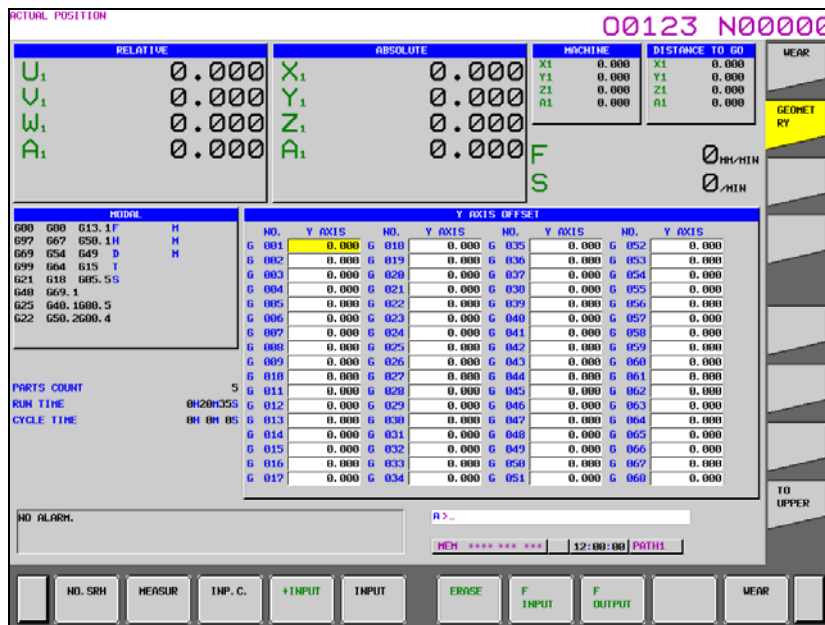

Fig. 2.1.7 (k) Y-axis offset screen (tool geometry)(15-inch display unit)

- 4 Position the cursor at the offset number to be changed by using either of the following methods:
  - Move the cursor to the offset number to be changed using page keys and cursor keys.
  - Type the offset number and press horizontal soft key [NO.SRH].
- 5 Enter the offset value.
- 6 Press horizontal soft key [INPUT]. The offset value is set and displayed.

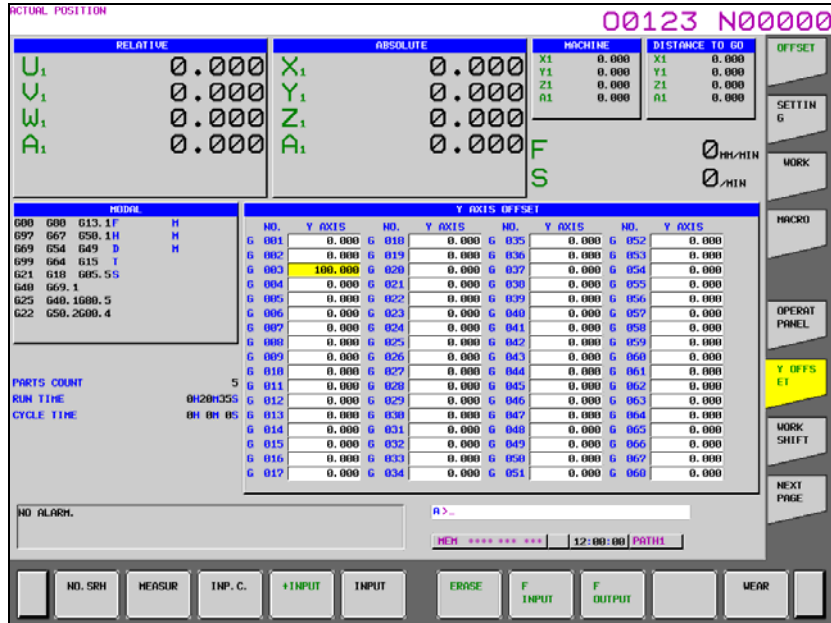



Fig. 2.1.7 (I) Y-axis offset screen (input) (15-inch display unit)

**Procedure for counter input of the offset value (for 8.4/10.4-inch display unit)**

To set relative coordinates along the Y-axis as offset values:

- 1 Move the reference tool to the reference point.
- 2 Reset relative coordinate Y to 0.
- 3 Move the tool for which offset values are to be set to the reference point.
- 4 Move the cursor to the value for the offset number to be set, press  key, then press soft key [INP.C.].  
Relative coordinate Y (or V) is now set as the offset value.

**Procedure for counter input of the offset value (for 15-inch display unit)**

To set relative coordinates along the Y-axis as offset values:

- 1 Move the reference tool to the reference point.
- 2 Reset relative coordinate Y to 0.
- 3 Move the tool for which offset values are to be set to the reference point.
- 4 Move the cursor to the value for the offset number to be set, press  key, then press horizontal soft key [INP.C.].  
Relative coordinate Y (or V) is now set as the offset value.

**2.1.8 Setting the 4th/5th Axis Offset**

**NOTE**  
"4th/5th axis offset" is an optional function.

By the operation described below, the 4th/5th axis offset screen can be displayed.

**Procedure for displaying and setting 4th/5th axis offset values (for 8.4/10.4-inch display unit)**

**Procedure**

- 1 Press function key .

- 2 Press the continuous menu key  several times until soft key [EXTEND OFFSET] is displayed.
- 3 Press soft key [EXTEND OFFSET] to display the 4th/5th axis offset screen. The number of tool offset values depends varies according to the number of added tool offset pairs. When the tool geometry offset function and tool wear offset function are used, soft keys [GEOMETRY] and [WEAR] are displayed.

| OFFSET |        |        | 00123 N00000 |       |
|--------|--------|--------|--------------|-------|
| NO.    | E AXIS | 5 AXIS | RELATIVE     |       |
| 035    | 0.000  | 0.000  | X1           | 0.000 |
| 036    | 0.000  | 0.000  | Z1           | 0.000 |
| 037    | 0.000  | 0.000  | C1           | 0.000 |
| 038    | 0.000  | 0.000  | Y1           | 0.000 |
| 039    | 0.000  | 0.000  | A1           | 0.000 |
| 040    | 0.000  | 0.000  | ABSOLUTE     |       |
| 041    | 0.000  | 0.000  | X1           | 0.000 |
| 042    | 0.000  | 0.000  | Z1           | 0.000 |
| 043    | 0.000  | 0.000  | C1           | 0.000 |
| 044    | 0.000  | 0.000  | Y1           | 0.000 |
| 045    | 0.000  | 0.000  | A1           | 0.000 |
| 046    | 0.000  | 0.000  | MACHINE      |       |
| 047    | 0.000  | 0.000  | X1           | 0.000 |
| 048    | 0.000  | 0.000  | Z1           | 0.000 |
| 049    | 0.000  | 0.000  | C1           | 0.000 |
| 050    | 0.000  | 0.000  | Y1           | 0.000 |
| 051    | 0.000  | 0.000  | A1           | 0.000 |

|     |      |      |                  |          |
|-----|------|------|------------------|----------|
| A > |      |      |                  |          |
| MEM | **** | **** | 12:00:00         | PATH1    |
|     |      |      | EXTEND<br>OFFSET | (OPRT) + |

Fig. 2.1.8 (a) 4th/5th axis offset screen (without tool geometry/wear offset) (10.4inch)

- 4 Pressing soft key [WEAR] displays tool wear offset values. Pressing soft key [GEOMETRY] displays tool geometry offset values.

| OFFSET / WEAR |        |        | 00123 N00000 |       |
|---------------|--------|--------|--------------|-------|
| NO.           | E AXIS | 5 AXIS | RELATIVE     |       |
| W 001         | 0.000  | 0.000  | X1           | 0.000 |
| W 002         | 0.000  | 0.000  | Z1           | 0.000 |
| W 003         | 0.000  | 0.000  | C1           | 0.000 |
| W 004         | 0.000  | 0.000  | Y1           | 0.000 |
| W 005         | 0.000  | 0.000  | A1           | 0.000 |
| W 006         | 0.000  | 0.000  | ABSOLUTE     |       |
| W 007         | 0.000  | 0.000  | X1           | 0.000 |
| W 008         | 0.000  | 0.000  | Z1           | 0.000 |
| W 009         | 0.000  | 0.000  | C1           | 0.000 |
| W 010         | 0.000  | 0.000  | Y1           | 0.000 |
| W 011         | 0.000  | 0.000  | A1           | 0.000 |
| W 012         | 0.000  | 0.000  | MACHINE      |       |
| W 013         | 0.000  | 0.000  | X1           | 0.000 |
| W 014         | 0.000  | 0.000  | Z1           | 0.000 |
| W 015         | 0.000  | 0.000  | C1           | 0.000 |
| W 016         | 0.000  | 0.000  | Y1           | 0.000 |
| W 017         | 0.000  | 0.000  | A1           | 0.000 |

|     |  |  |          |              |
|-----|--|--|----------|--------------|
| A > |  |  |          |              |
|     |  |  | MEM      | ****         |
|     |  |  | 12:00:00 | PATH1        |
| <   |  |  | WEAR     | GEOMET<br>RY |
|     |  |  |          | (OPRT)       |

Fig. 2.1.8 (b) 4th/5th axis offset screen (with tool geometry/wear offset) (10.4inch)

- 5 Pressing soft key [(OPRT)] displays soft keys [NO.SRH], [+INPUT], [INPUT], [ERASE], [F INPUT], and [F OUTPUT].

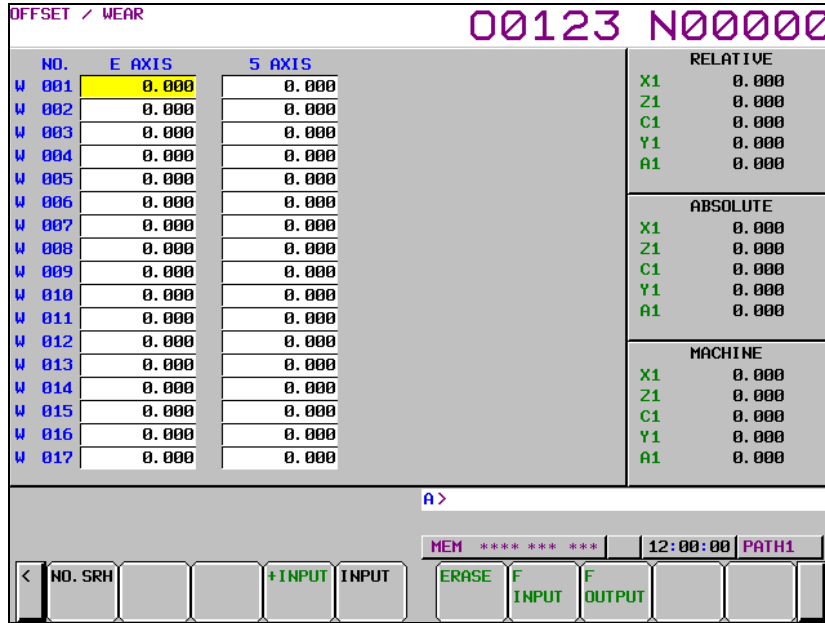



Fig. 2.1.8 (c) 4th/5th axis offset screen (operation)(10.4inch)

**Procedure for displaying and setting 4th/5th axis offset values (for 15-inch display unit)**

**Procedure**

- 1 Press function key .
- 2 Press vertical soft key [NEXT PAGE] several times until vertical soft key [EXTEND OFFSET] is displayed.
- 3 Press vertical soft key [EXTEND OFFSET] to display the 4th/5th axis offset screen. The number of tool offset values depends varies according to the number of added tool offset sets. When the tool geometry offset function and tool wear offset function are used, horizontal soft keys [GEOMETRY] and [WEAR] are displayed.

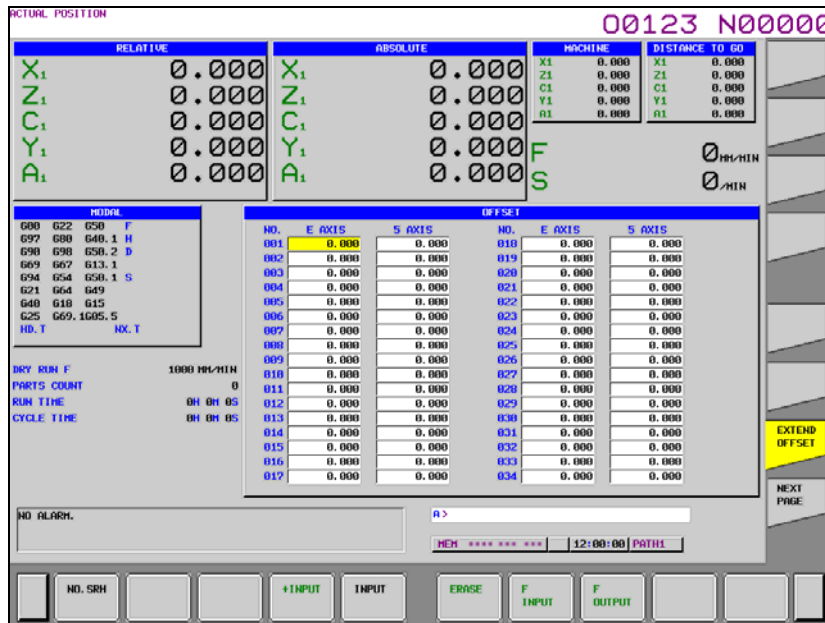

Fig. 2.1.8 (d) 4th/5th axis offset screen (without tool geometry/wear offset) (15-inch display unit)

- 4 Pressing horizontal soft key [WEAR] displays tool wear offset values. Pressing horizontal soft key [GEOMETRY] displays tool geometry offset values. Moreover, soft keys [NO.SRH], [+INPUT], [INPUT], [ERASE], [F INPUT], and [F OUTPUT] are displayed.

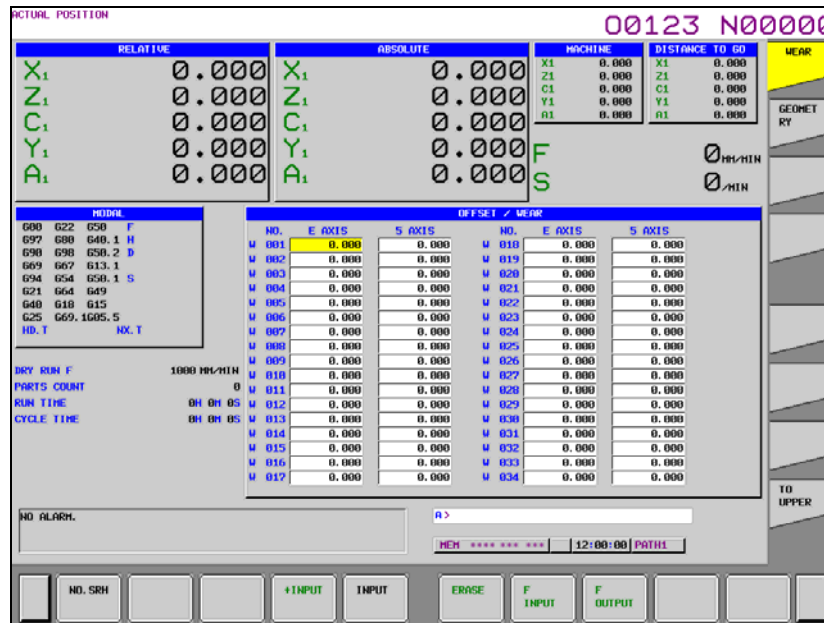

Fig. 2.1.8 (e) 4th/5th axis offset screen (with tool geometry/wear offset) (15-inch display unit)

## Displaying tool offset values (for 8.4/10.4-inch display unit)

A tool offset value can be displayed using the procedure below.

### Procedure

- 1 By using the page keys and cursor keys, move the cursor to a tool offset value to be displayed.
- 2 Type the tool offset value number to be displayed then press soft key [NO.SRH].

## Setting tool offset values (for 8.4/10.4-inch display unit)

A tool offset value can be set or modified by using the procedure below.

### Procedure

- 1 To set a tool offset value, move the cursor to the tool offset value position to be changed. Next, type the desired offset value then press MDI key .
- 2 To set a tool offset value, move the cursor to the tool offset value position to be changed. Next, type the desired offset value then press soft key [INPUT].
- 3 To modify a tool offset value, type a desired incremental or decremental value then press soft key [+INPUT].

## Displaying tool offset values (for 15-inch display unit)

A tool offset value can be displayed using the procedure below.

### Procedure

- 1 By using the page keys and cursor keys, move the cursor to a tool offset value to be displayed.
- 2 Type the tool offset value number to be displayed then press horizontal soft key [NO.SRH].



## Setting tool offset values (for 15-inch display unit)

A tool offset value can be set or modified by using the procedure below.

### Procedure

- 1 To set a tool offset value, move the cursor to the tool offset value position. Next, type the desired offset value then press MDI key .
- 2 To set a tool offset value, move the cursor to the tool offset value position. Next, type the desired offset value then press horizontal soft key [INPUT].
- 3 To modify a tool offset value, type a desired incremental or decremental value then press horizontal soft key [+INPUT].

## Erasing all tool offset values in a batch (for 8.4/10.4-inch display unit)

By pressing soft key [ERASE], all tool offset values can be erased in a batch. The term "erase" means the setting of tool offset values to 0. So, when erasing tool offset values not in a batch but on a one-by-one basis, set an individual tool offset value to 0 in tool offset value setting operation.

### Procedure

- 1 Pressing soft key [(OPRT)] on the 4th/5th axis offset screen displays soft keys [NO.SRH], [+INPUT], [INPUT], [ERASE], [F INPUT], and [F OUTPUT].
- 2 Press soft key [ERASE].
- 3 Soft key [ALL] is displayed.  
If the tool geometry/wear compensation is enabled (bit 6 (NGW) of parameter No.8136 is 0), soft keys [GEOMETRY] and [WEAR] are displayed in addition to soft key [ALL].

| OFFSET / WEAR |        |        | 00123 N00000 |       |
|---------------|--------|--------|--------------|-------|
| NO.           | E AXIS | 5 AXIS | RELATIVE     |       |
| W 001         | 0.000  | 0.000  | X1           | 0.000 |
| W 002         | 0.000  | 0.000  | Z1           | 0.000 |
| W 003         | 0.000  | 0.000  | C1           | 0.000 |
| W 004         | 0.000  | 0.000  | Y1           | 0.000 |
| W 005         | 0.000  | 0.000  | A1           | 0.000 |
| W 006         | 0.000  | 0.000  | ABSOLUTE     |       |
| W 007         | 0.000  | 0.000  | X1           | 0.000 |
| W 008         | 0.000  | 0.000  | Z1           | 0.000 |
| W 009         | 0.000  | 0.000  | C1           | 0.000 |
| W 010         | 0.000  | 0.000  | Y1           | 0.000 |
| W 011         | 0.000  | 0.000  | A1           | 0.000 |
| W 012         | 0.000  | 0.000  | MACHINE      |       |
| W 013         | 0.000  | 0.000  | X1           | 0.000 |
| W 014         | 0.000  | 0.000  | Z1           | 0.000 |
| W 015         | 0.000  | 0.000  | C1           | 0.000 |
| W 016         | 0.000  | 0.000  | Y1           | 0.000 |
| W 017         | 0.000  | 0.000  | A1           | 0.000 |

A >

|           |          |          |       |
|-----------|----------|----------|-------|
| MEM ***** |          | 12:00:00 | PATH1 |
| < ALL     | GEOMETRY | WEAR     |       |

Fig. 2.1.8 (f) 4th/5th axis offset screen (erase operation) (10.4inch)

- 4 Pressing soft key [ALL] clears all tool offset values. Pressing soft key [WEAR] clears all wear offset values. Pressing soft key [GEOMETRY] clears all geometry offset values.

## Erasing all tool offset values in a batch (for 15-inch display unit)

By pressing horizontal soft key [ERASE], all tool offset values can be erased in a batch. The term "erase" means the setting of tool offset values to 0. So, when erasing tool offset values not in a batch but on a one-by-one basis, set an individual tool offset value to 0 in tool offset value setting operation.

**Procedure**

- 1 Press horizontal soft key [ERASE] on the 4th/5th axis offset screen.
- 2 Horizontal soft key [ALL] is displayed.  
If the tool geometry/wear compensation is enabled (bit 6 (NGW) of parameter No.8136 is 0), horizontal soft keys [GEOMETRY] and [WEAR] are displayed in addition to horizontal soft key [ALL].

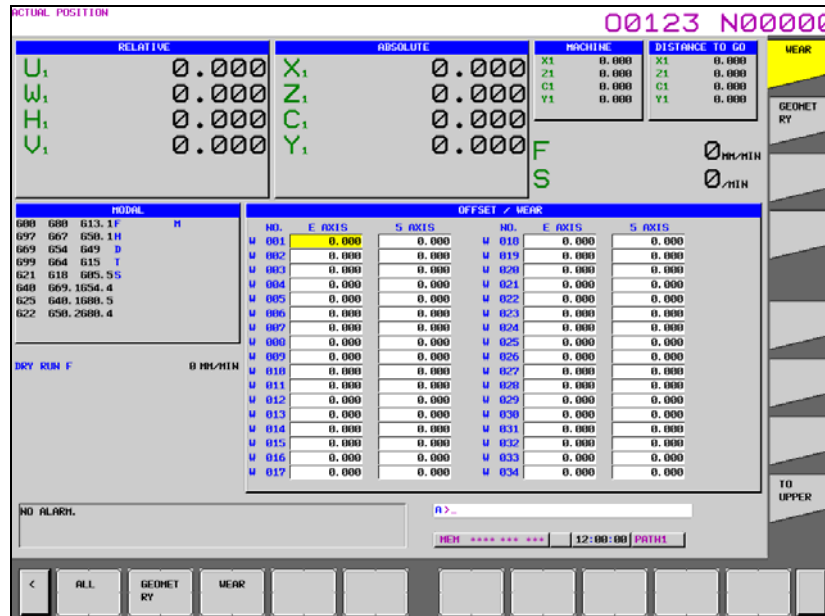

Fig. 2.1.8 (g) 4th/5th axis offset screen (erase operation) (15-inch display unit)

- 3 Press horizontal soft key [ALL], then pressing horizontal soft key [EXEC] clears all tool offset values.  
Pressing horizontal soft key [WEAR] clears all wear offset values. Pressing horizontal soft key [GEOMETRY] clears all geometry offset values.

**2.1.9 Chuck and Tail Stock Barriers**

The chuck and tail stock barrier function prevents damage to the machine by checking whether the tool nose fouls either the chuck or tail stock. Specify an area into which the tool may not enter (entry-inhibition area). This is done using the special setting screen, according to the shapes of the chuck and tail stock. If the tool nose should enter the set area during a machining operation, this function stops the tool and outputs an alarm message. The tool can be cleared from the area only by retracting it in the direction opposite to that in which the tool entered the area.

**NOTE**  
The "chuck and tail stock barriers" function is available, when bit 1 (BAR) of parameter No.8134 is 1.

**Setting the chuck and tail stock barriers (for 8.4/10.4-inch display unit)**

- **Setting the shapes of the chuck and tail stock**
  - 1 Press function key
  - 2 Press the continuous menu key . Then, press chapter selection soft key [CHUCK TAIL].
  - 3 Pressing the page key or toggles the display between the chuck barrier setting screen and tail stock barrier setting screen.

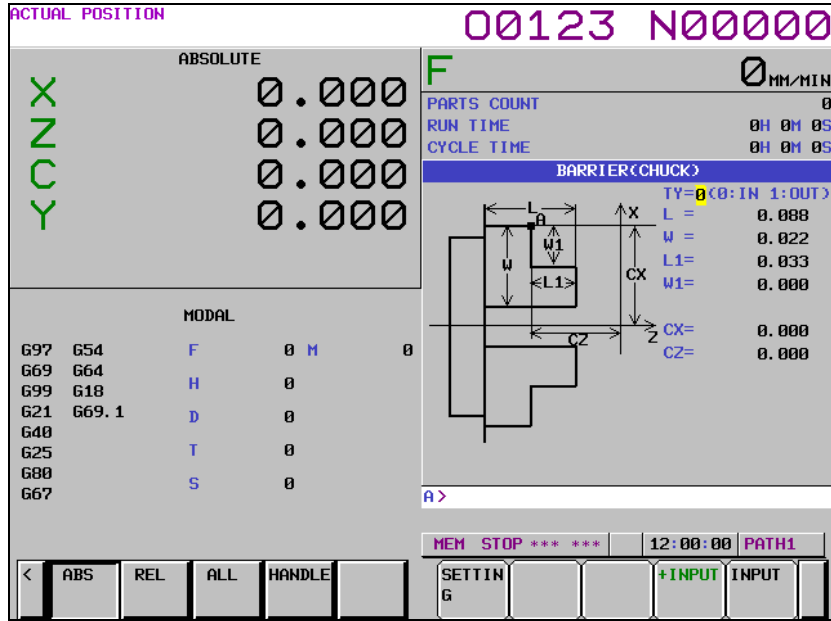

Fig. 2.1.9 (a) Chuck barrier setting screen (10.4-inch display unit)

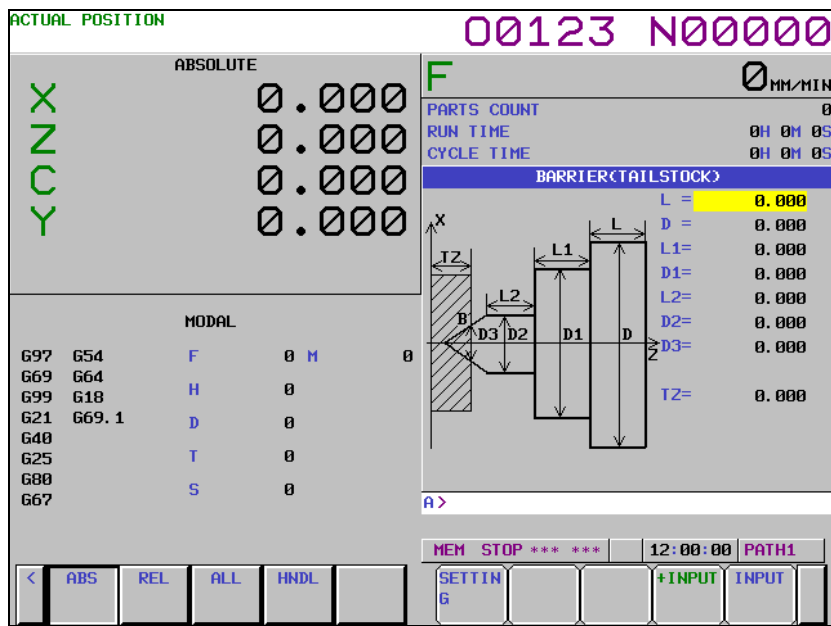

Fig. 2.1.9 (b) Tail stock barrier setting screen (10.4-inch display unit)

- Position the cursor to each item defining the shape of the chuck or tail stock, enter the corresponding value, then press soft key [INPUT]. The value is set. Pressing soft key [+INPUT] after a value has been entered adds the entered value to the current value, the new setting being the sum of the two values.

Items CX and CZ, both on the chuck barrier setting screen, and item TZ on the tail stock barrier setting screen can also be set in another way. Manually move the tool to the desired position, then press soft key [SETTING] to set the coordinate(s) of the tool in the workpiece coordinate system. If a tool having an offset other than 0 is manually moved to the desired position with no compensation applied, compensate for the tool offset in the set coordinate system. Items other than CX, CZ, and TZ cannot be set by using soft key [SETTING].

Example

When an alarm is issued, the tool stops before the entry-inhibition area if bit 7 (BFA) of parameter No. 1300 is set to 1. If bit 7 (BFA) of parameter No. 1300 is set to 0, the tool stops at a more inside position than the specified figure because the CNC and machine system stop with some delay in time.

For safety, therefore, set an area a little larger than the determined area. The distance between the boundaries of these two areas, L, is calculated from the following equation, based on the rapid traverse rate.

$$L = (\text{Rapid traverse rate}) \times \frac{1}{7500}$$

When the rapid traverse rate is 15 m/min, for example, set an area having a boundary 2 mm outside that of the determined area.



The shapes of the chuck and tail stock can be set using parameters Nos. 1330 to 1336 and Nos. 1341 to 1348

**NOTE**

Set G23 mode before attempting to specify the shapes of the chuck and tail stock.

**Setting the chuck and tail stock barriers (for 15-inch display unit)**

- **Setting the shapes of the chuck and tail stock**

- 1 Press function key .
- 2 Press vertical soft key [NEXT PAGE] several times until soft key [CHUCK TAIL] is displayed.
- 3 Press vertical soft key [CHUCK TAIL].
- 4 Pressing the page key  or  toggles the display between the chuck barrier setting screen and tail stock barrier setting screen.

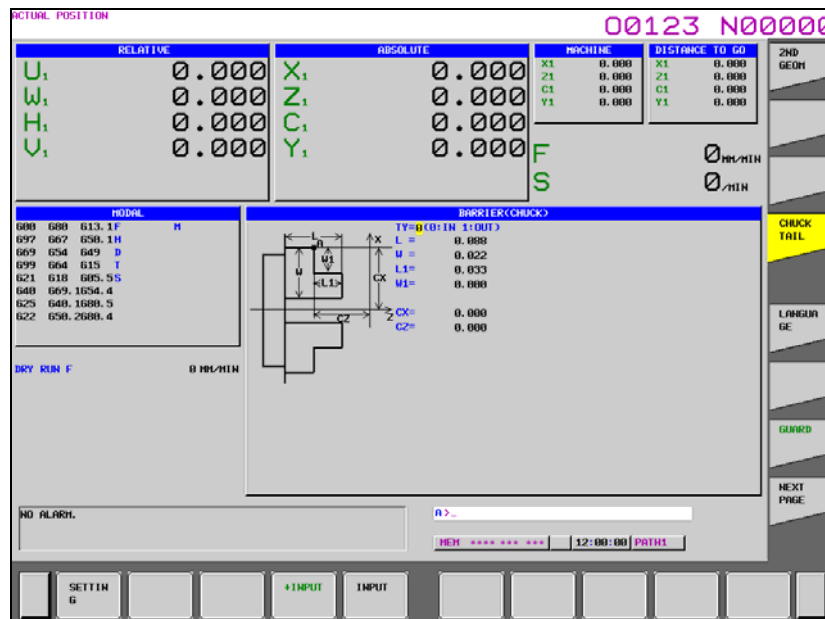

Fig. 2.1.9 (c) Chuck barrier setting screen (15-inch display unit)

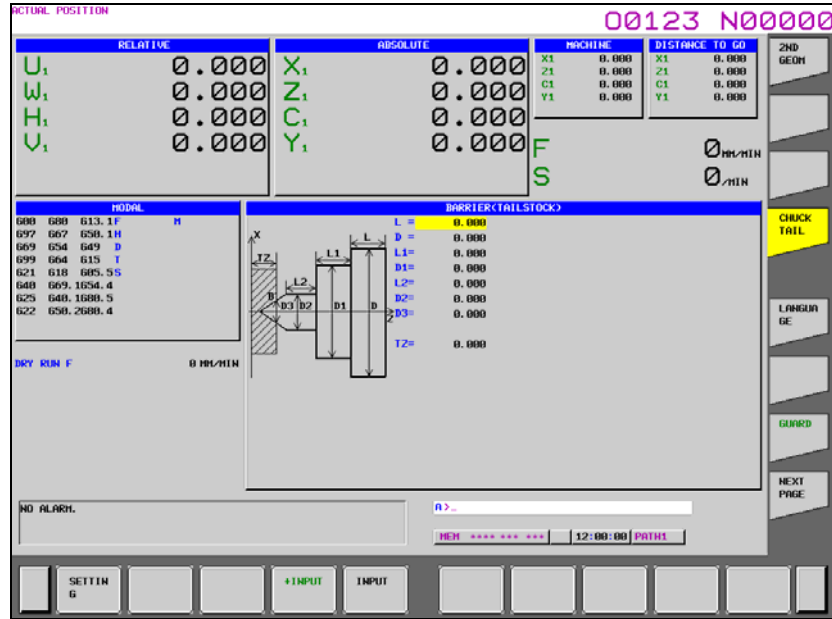

Fig. 2.1.9 (d) Tail stock barrier setting screen (15-inch display unit)

- 5 Position the cursor to each item defining the shape of the chuck or tail stock, enter the corresponding value, then press horizontal soft key [INPUT]. The value is set. Pressing horizontal soft key [+INPUT] after a value has been entered adds the entered value to the current value, the new setting being the sum of the two values.

Items CX and CZ, both on the chuck barrier setting screen, and item TZ on the tail stock barrier setting screen can also be set in another way. Manually move the tool to the desired position, then press horizontal soft key [SETTING] to set the coordinate(s) of the tool in the workpiece coordinate system. If a tool having an offset other than 0 is manually moved to the desired position with no compensation applied, compensate for the tool offset in the set coordinate system. Items other than CX, CZ, and TZ cannot be set by using horizontal soft key [SETTING].

#### Example

When an alarm is issued, the tool stops before the entry-inhibition area if bit 7 (BFA) of parameter No. 1300 is set to 1. If bit 7 (BFA) of parameter No. 1300 is set to 0, the tool stops at a more inside position than the specified figure because the CNC and machine system stop with some delay in time.

For safety, therefore, set an area a little larger than the determined area. The distance between the boundaries of these two areas, L, is calculated from the following equation, based on the rapid traverse rate.

$$L = (\text{Rapid traverse rate}) \times \frac{1}{7500}$$

When the rapid traverse rate is 15 m/min, for example, set an area having a boundary 2 mm outside that of the determined area.

The shapes of the chuck and tail stock can be set using parameters Nos. 1330 to 1336 and Nos. 1341 to 1348

#### NOTE

Set G23 mode before attempting to specify the shapes of the chuck and tail stock.

#### - Reference position return

Return the tool to the reference position along the X- and Z-axes.

The chuck-tail stock barrier function becomes effective only once reference position return has been completed after power on.

When an absolute position detector is provided, reference position return need not always be performed. The positional relationship between the machine and the absolute position detector, however, must be determined.

**- G22/G23**

When G22 (stored stroke limit on) is specified, the chuck and tail stock area becomes an entry-inhibition area. When G23 (stored stroke limit off) is specified, the entry-inhibition area is canceled. Each of G22; and G23; should be commanded independently of another commands in a block. Even if G22 is specified, the entry-inhibition area for the tail stock can be disabled by issuing a tail stock barrier selection signal \*TSB. When the tail stock is pushed up against a workpiece or separated from the workpiece by using the auxiliary functions, PMC signals are used to enable or disable the tail stock setting area.

**Table 2.1.9 (a)**

| G code | Tail stock barrier selection signal | Chuck barrier | Tail stock barrier |
|--------|-------------------------------------|---------------|--------------------|
| G22    | "0"                                 | Valid         | Valid              |
|        | "1"                                 | Valid         | Invalid            |
| G23    | Unrelated                           | Invalid       | Invalid            |

G22 is selected when the power is turned on. Using G23, bit 7 of parameter No. 3402, however, it can be changed to G23.

**Explanation**

**- Setting the shape of the chuck barrier**

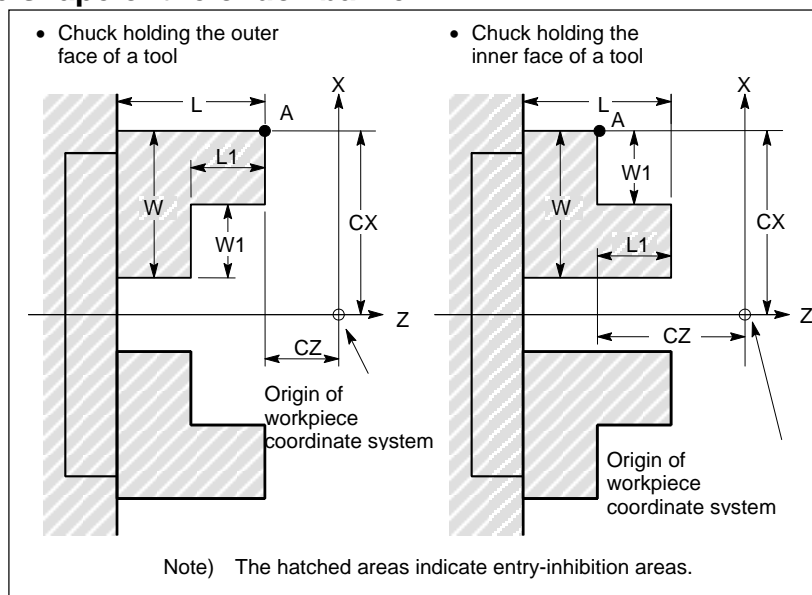

**Fig. 2.1.9 (e)**

**Table2.1.9 (b)**

| Symbol | Description  |
|--------|--|
| TY     | Chuck-shape selection (0: Holding the inner face of a tool, 1: Holding the outer face of a tool) |
| CX     | Chuck position (along X-axis)  |
| CZ     | Chuck position (along Z-axis)  |
| L      | Length of chuck jaws   |
| W      | Depth of chuck jaws (radius)   |
| L1     | Holding length of chuck jaws   |
| W1     | Holding depth of chuck jaws (radius)   |

TY : Selects a chuck type, based on its shape. Specifying 0 selects a chuck that holds the inner face of a tool. Specifying 1 selects a chuck that holds the outer face of a tool. A chuck is assumed to be symmetrical about its Z-axis.

CX, CZ :

Specify the coordinates of a chuck position, point A, in the workpiece coordinate system. These coordinates are not the same as those in the machine coordinate system. The unit of data is indicated in Table 2.1.9 (c).

The direction of the the chuck and of the tail stock are defined by a big and small relation between CZ and TZ (Z coordinate of a tail stock). Please refer to "Setting of direction of chuck and of tail stock" for details.

**⚠ CAUTION**

- 1 Whether diameter programming or radius programming is used for the axis determines the programming system. When diameter programming is used for the axis, use diameter programming to enter data for the axis.
- 2 The CZ is used to define the direction of the chuck and of the tail stock. Even when you not use the forbidden area for a chuck, please set to CZ.

Table 2.1.9 (c)

| Increment system | Unit of data |              | Valid data range       |
|------------------|--------------|--------------|------------------------|
|                  | IS-A         | IS-B         |                        |
| Metric input     | 0.001 mm     | 0.0001 mm    | -99999999 to +99999999 |
| Inch input       | 0.0001 inch  | 0.00001 inch | -99999999 to +99999999 |

L, L1, W, W1 : Define the figure of a chuck. The unit of data is indicated in Table 2.1.9 (c).

**⚠ CAUTION**

- 1 Always specify W and W1 in radius. When radius programming is used for the Z-axis, specify L and L1 in radius.
- 2 If you not use the forbidden area for a chuck, please set 0 to L, L1, W and W1.

- Setting the shape of a tail stock barrier

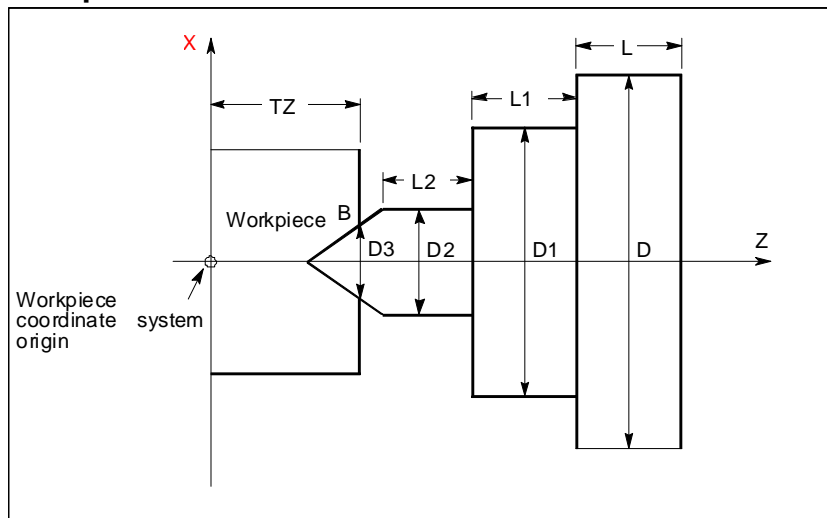

Fig. 2.1.9 (f)

Table 2.1.9 (d)

| Symbol | Description                            |
|--------|--|
| TZ     | Tail stock position (along the Z-axis) |
| L      | Tail stock length                      |

| Symbol | Description                  |
|--------|------------------------------|
| D      | Tail stock diameter          |
| L1     | Tail stock length (1)        |
| D1     | Tail stock diameter (1)      |
| L2     | Tail stock length (2)        |
| D2     | Tail stock diameter (2)      |
| D3     | Tail stock hole diameter (3) |

TZ : Specifies the Z coordinate of the chuck position, point B, in the workpiece coordinate system. These coordinates are not the same as those in the machine coordinate system. The unit of data is indicated in Table 2.1.9 (c). A tail stock is assumed to be symmetrical about its Z-axis.

The direction of the chuck and of the tail stock is defined by a big and small relation between CZ (Z coordinate of a chuck) and TZ. Please refer to "Setting of direction of chuck and of tail stock" for details.

### ⚠ CAUTION

- 1 Whether diameter programming or radius programming is used for the Z-axis determines the programming system.
- 2 The TZ is used to define the direction of the chuck and of the tail stock. Even when you not use the forbidden area for a tail stock, please set to TZ.

L, L1, L2, D, D1, D2, D3 :

Define the figure of a tail stock. The valid data range is indicated in Table 2.1.9 (c).

### ⚠ CAUTION

- 1 Always specify D, D1, D2, and D3 in diameter programming. When radius programming is used for the Z-axis, specify L, L1, and L2 in radius.
- 2 If you not use the forbidden area for a tail stock, please set 0 to L, L1, L2, D, D1, D2 and D3.

#### - Setting the entry-inhibition area for the tail stock tip

The tip angle of the tail stock is 60 degrees. The entry-inhibition area is set around the tip, assuming the angle to be 90 degrees, as shown below.

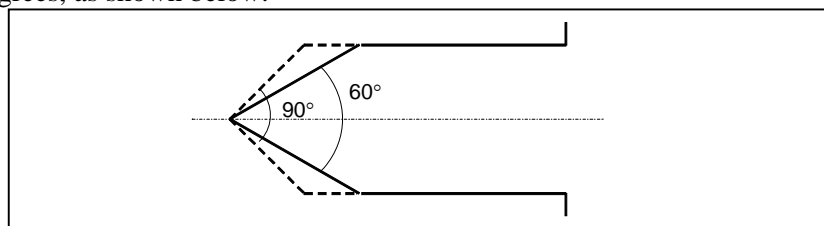

Fig. 2.1.9 (g)

#### - Setting of direction of chuck and of tail stock

Setting of direction of forbidden area for a chuck and of forbidden area for a tail stock is decided by a big and small relation between parameter No.1336 (CZ) and parameter No.1348 (TZ). When set to CZ<TZ, the direction of the chuck and of the tail stock becomes direction shown in Fig. 2.1.9 (h). When set to CZ>TZ, the direction of the chuck and of the tail stock becomes direction shown in Fig. 2.1.9 (i).

When you use only forbidden area for a chuck, please set the following to parameter No.1348 (TZ).

- When you set the direction of the chuck as shown in Fig. 2.1.9 (h), please set a value that is larger than CZ to TZ
- When you set the direction of the chuck as shown in Fig. 2.1.9 (i), please set a value that is smaller than CZ to TZ



When you use only forbidden area for a tail stock, please set the following to parameter No.1336 (CZ).

- When you set the direction of the tail stock as shown in Fig. 2.1.9 (h), please set a value that is smaller than TZ to CZ
- When you set the direction of the tail stock as shown in Fig. 2.1.9 (i), please set a value that is larger than TZ to CZ

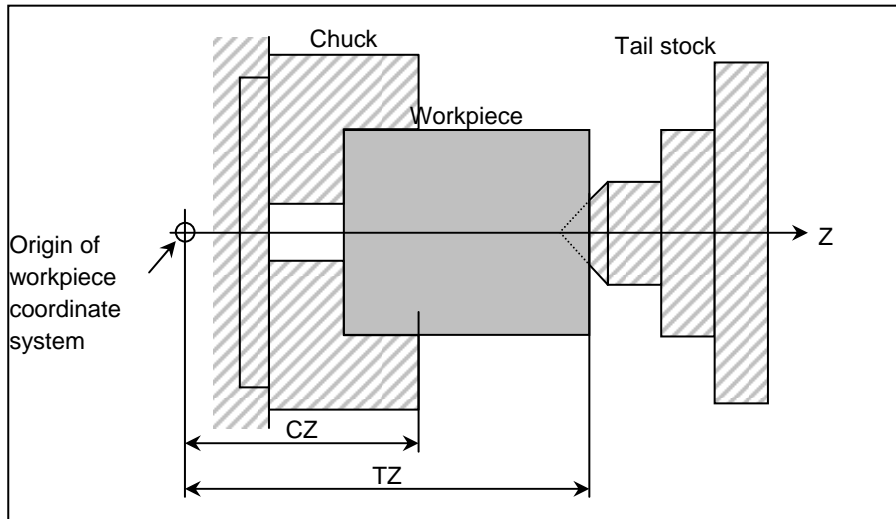

Fig. 2.1.9 (h) For parameter No.1336(CZ) < parameter No.1348(TZ)

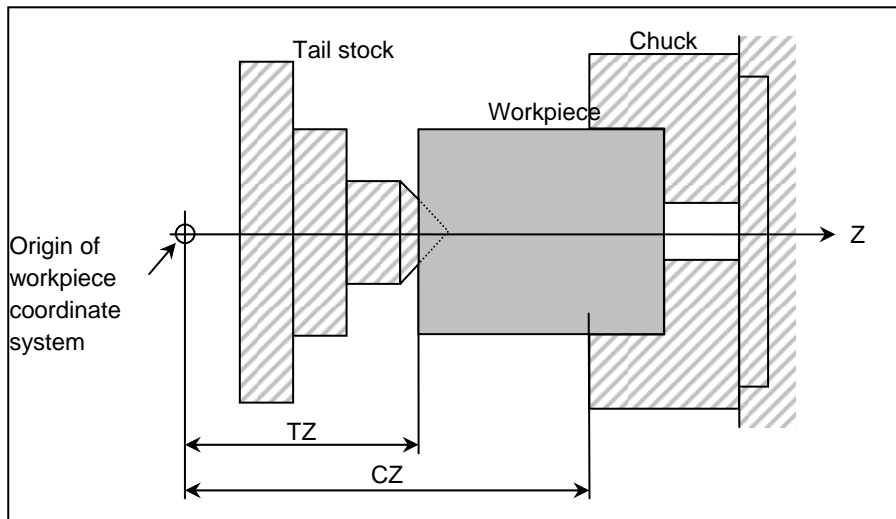

Fig. 2.1.9 (i) For parameter No.1336(CZ) > parameter No.1348(TZ)

## Limitation

### - Correct setting of an entry-inhibition area

If an entry-inhibition area is incorrectly set, it may not be possible to make the area effective. Avoid making the following settings:

- $L \leq L1$  or  $W \leq W1$  in the chuck-shape settings.
- $D2 \leq D3$  in the tail stock-shape settings.
- A chuck setting overlapping that of the tail stock.

### - When you use only the chuck or only the tail stock

Setting of direction of forbidden area for a chuck and of forbidden area for a tail stock is decided by a big and small relation between CZ and TZ. Even when you use only the chuck or only the tail stock, please

set a big and small relation between CZ and TZ appropriately. Please refer to "Setting of direction of chuck and of tail stock" for details.

If you not use the forbidden area for a chuck, please set 0 to L, L1, W and W1 of the chuck-shape settings.

If you not use the forbidden area for a tail stock, please set 0 to L, L1, L2, D, D1, D2 and D3 of the tail stock-shape settings.

### - Retraction from the entry-inhibition area

If the tool enters the entry-inhibition area and an alarm is issued, switch to manual mode, retract the tool manually, then reset the system to release the alarm. In manual mode, the tool can be moved only in the opposite direction to that in which the tool entered the area.

The tool cannot be moved in the same direction (further into the area) as it was traveling when the tool entered the area.

When the entry-inhibition areas for the chuck and tail stock are enabled, and the tool is already positioned within those areas, an alarm is issued when the tool moves.

When the tool cannot be retracted, change the setting of the entry-inhibition areas, such that the tool is outside the areas, reset the system to release the alarm, then retract the tool. Finally, reinstall the original settings.

### - Coordinate system

An entry-inhibition area is defined using the workpiece coordinate system. Note the following.

<1> When the workpiece coordinate system is shifted by means of a command or operation, the entry-inhibition area is also shifted by the same amount.

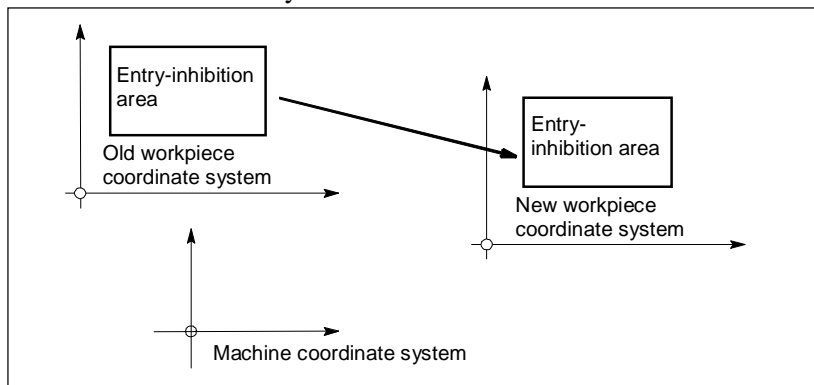

Fig. 2.1.9 (j)

Use of the following commands and operations will shift the workpiece coordinate system.

Commands:

G54 to G59, G52, G50 (G92 in G code system B or C)

Operations:

Manual handle interruption, change in offset relative to the workpiece origin, change in tool offset (tool geometry offset), operation with machine lock, manual operation with manual absolute signal off

<2> When the tool enters an entry-inhibition area during automatic operation, set the manual absolute signal, \*ABSM, to "0" (on), then manually retract the tool from the area. If this signal is "1", the distance the tool moves in manual operation is not counted in the tool coordinates in the workpiece coordinate system. This results in the state where the tool can never be retracted from the entry-inhibition area.

### - Stored stroke check 2/3

When both stored stroke check 2/3 and the chuck tail stock barrier function are provided, the barrier takes priority over the stored stroke check. Stored stroke check 2/3 is ignored.

# **APPENDIX**



# A PARAMETERS

This manual describes all parameters indicated in this manual.

For those parameters that are not indicated in this manual and other parameters, refer to the parameter manual.

Appendix A, "PARAMETERS", consists of the following sections:

A.1 DESCRIPTION OF PARAMETERS .....359  
 A.2 DATA TYPE.....408  
 A.3 STANDARD PARAMETER SETTING TABLES .....409

## A.1 DESCRIPTION OF PARAMETERS

|      |    |    |    |    |    |    |     |    |
|------|----|----|----|----|----|----|-----|----|
|      | #7 | #6 | #5 | #4 | #3 | #2 | #1  | #0 |
| 0001 |    |    |    |    |    |    | FCV |    |

[Input type] Setting input

[Data type] Bit path

#1 FCV Program format

0: Series 0i standard format

1: Series 10/11 format

**NOTE**

1 Programs created in the Series 10/11 program format can be used for operation on the following functions:

- 1 Subprogram call M98
- 2 Thread cutting with equal leads G32
- 3 Canned cycle G90, G92, G94
- 4 Multiple repetitive canned cycle G71 to G76
- 5 Drilling canned cycle G83.1, G80 to G89

2 When the program format used in the Series 10/11 is used for this CNC, some limits may add. Refer to the Operator’s Manual.

|      |   |
|------|---|
| 1022 | Setting of each axis in the basic coordinate system |
|------|---|

[Input type] Parameter input

[Data type] Byte axis

[Valid data range] 0 to 7

To determine a plane for circular interpolation, cutter compensation, and so forth (G17: Xp-Yp plane, G18: Zp-Xp plane, G19: Yp-Zp plane), specify which of the basic three axes (X, Y, and Z) is used for each control axis, or a parallel axis of which basic axis is used for each control axis.

A basic axis (X, Y, or Z) can be specified only for one control axis.

Two or more control axes can be set as parallel axes for the same basic axis.

| Setting | Meaning   |
|---------|---|
| 0       | Rotary axis (Neither the basic three axes nor a parallel axis ) |
| 1       | X axis of the basic three axes                                  |
| 2       | Y axis of the basic three axes                                  |
| 3       | Z axis of the basic three axes                                  |

| Setting | Meaning                     |
|---------|-----------------------------|
| 5       | Axis parallel to the X axis |
| 6       | Axis parallel to the Y axis |
| 7       | Axis parallel to the Z axis |

In general, the increment system and diameter/radius specification of an axis set as a parallel axis are to be set in the same way as for the basic three axes.

|             |   |
|-------------|---|
| <b>1290</b> | <b>Distance between two opposite tool posts in mirror image</b> |
|-------------|---|

[Input type] Parameter input  
 [Data type] Real path  
 [Unit of data] mm, inch (input unit)  
 [Min. unit of data] Depend on the increment system of the reference axis  
 [Valid data range] 0 or positive 9 digit of minimum unit of data (refer to the standard parameter setting table (B))  
 (When the increment system is IS-B, 0.0 to +999999.999)  
 Set the distance between two opposite tool posts in mirror image.

|             |   |    |    |    |    |    |    |    |    |            |  |  |  |  |  |  |  |
|-------------|---|----|----|----|----|----|----|----|----|------------|--|--|--|--|--|--|--|
| <b>1300</b> | <table border="1" style="width: 100%; border-collapse: collapse;"> <tr> <td style="width: 12.5%; text-align: center;">#7</td> <td style="width: 12.5%; text-align: center;">#6</td> <td style="width: 12.5%; text-align: center;">#5</td> <td style="width: 12.5%; text-align: center;">#4</td> <td style="width: 12.5%; text-align: center;">#3</td> <td style="width: 12.5%; text-align: center;">#2</td> <td style="width: 12.5%; text-align: center;">#1</td> <td style="width: 12.5%; text-align: center;">#0</td> </tr> <tr> <td style="text-align: center;"><b>BFA</b></td> <td></td> <td></td> <td></td> <td></td> <td></td> <td></td> <td></td> </tr> </table> | #7 | #6 | #5 | #4 | #3 | #2 | #1 | #0 | <b>BFA</b> |  |  |  |  |  |  |  |
| #7          | #6  | #5 | #4 | #3 | #2 | #1 | #0 |    |    |            |  |  |  |  |  |  |  |
| <b>BFA</b>  |   |    |    |    |    |    |    |    |    |            |  |  |  |  |  |  |  |

[Input type] Setting input  
 [Data type] Bit path

**#7 BFA** When the stored stroke check 1, 2, or 3 alarm is issued, an interference alarm is issued with the inter-path interference check function (T series) or a chuck/tail stock barrier (T series) alarm is issued:  
 0: The tool stops after entering the prohibited area.  
 1: The tool stops before the prohibited area.

**NOTE**  
 1 This parameter is valid even in AI contour control.  
 2 This parameter is invalid for the slave axis under axis synchronous control.

|             |                           |
|-------------|---------------------------|
| <b>1330</b> | <b>Profile of a chuck</b> |
|-------------|---------------------------|

[Input type] Parameter input  
 [Data type] Byte path  
 [Valid data range] 0 to 1  
 Select a chuck figure.  
 0: Chuck which holds a workpiece on the inner surface  
 1: Chuck which holds a workpiece on the outer surface

|             |  |
|-------------|--|
| <b>1331</b> | <b>Dimensions of the claw of a chuck (L)</b> |
|-------------|--|

[Input type] Parameter input  
 [Data type] Real path  
 [Unit of data] mm, inch (input unit)  
 [Min. unit of data] Depend on the increment system of the applied axis  
 [Valid data range] 0 or positive 9 digit of minimum unit of data (refer to the standard parameter setting table (B))  
 (When the increment system is IS-B, 0.0 to +999999.999)

Set the length (L) of the claw of the chuck.

**NOTE**  
Whether to specify this parameter by using a diameter value or radius value depends on whether the corresponding axis is based on diameter specification or radius specification.

|             |  |
|-------------|--|
| <b>1332</b> | <b>Dimensions of the claw of a chuck (W)</b> |
|-------------|--|

[Input type] Parameter input  
 [Data type] Real path  
 [Unit of data] mm, inch (input unit)  
 [Min. unit of data] Depend on the increment system of the applied axis  
 [Valid data range] 0 or positive 9 digit of minimum unit of data (refer to the standard parameter setting table (B))  
 (When the increment system is IS-B, 0.0 to +999999.999)  
 Set the width (W) of the claw of the chuck.

**NOTE**  
Specify this parameter by using a radius value at all times.

|             |   |
|-------------|---|
| <b>1333</b> | <b>Dimensions of the claw of a chuck (L1)</b> |
|-------------|---|

[Input type] Parameter input  
 [Data type] Real path  
 [Unit of data] mm, inch (input unit)  
 [Min. unit of data] Depend on the increment system of the applied axis  
 [Valid data range] 0 or positive 9 digit of minimum unit of data (refer to the standard parameter setting table (B))  
 (When the increment system is IS-B, 0.0 to +999999.999)  
 Set the length (L1) of the claw of the chuck.

**NOTE**  
Whether to specify this parameter by using a diameter value or radius value depends on whether the corresponding axis is based on diameter specification or radius specification.

|             |   |
|-------------|---|
| <b>1334</b> | <b>Dimensions of the claw of a chuck (W1)</b> |
|-------------|---|

[Input type] Parameter input  
 [Data type] Real path  
 [Unit of data] mm, inch (input unit)  
 [Min. unit of data] Depend on the increment system of the applied axis  
 [Valid data range] 0 or positive 9 digit of minimum unit of data (refer to the standard parameter setting table (B))  
 (When the increment system is IS-B, 0.0 to +999999.999)  
 Set the width (W1) of the claw of the chuck.

**NOTE**  
Specify this parameter by using a radius value at all times.

|      |                              |
|------|------------------------------|
| 1335 | X coordinate of a chuck (CX) |
|------|------------------------------|

- [Input type] Parameter input  
 [Data type] Real path  
 [Unit of data] mm, inch (input unit)  
 [Min. unit of data] Depend on the increment system of the applied axis  
 [Valid data range] 9 digit of minimum unit of data (refer to standard parameter setting table (A))  
 (When the increment system is IS-B, -999999.999 to +999999.999)  
 Set the chuck position (X coordinate) in the workpiece coordinate system.

**NOTE**

Whether to specify this parameter by using a diameter value or radius value depends on whether the corresponding axis is based on diameter specification or radius specification.

|      |                              |
|------|------------------------------|
| 1336 | Z coordinate of a chuck (CZ) |
|------|------------------------------|

- [Input type] Parameter input  
 [Data type] Real path  
 [Unit of data] mm, inch (input unit)  
 [Min. unit of data] Depend on the increment system of the applied axis  
 [Valid data range] 9 digit of minimum unit of data (refer to standard parameter setting table (A))  
 (When the increment system is IS-B, -999999.999 to +999999.999)  
 Set the chuck position (Z coordinate) in the workpiece coordinate system.

**NOTE**

Whether to specify this parameter by using a diameter value or radius value depends on whether the corresponding axis is based on diameter specification or radius specification.

|      |                            |
|------|----------------------------|
| 1341 | Length of a tail stock (L) |
|------|----------------------------|

- [Input type] Parameter input  
 [Data type] Real path  
 [Unit of data] mm, inch (input unit)  
 [Min. unit of data] Depend on the increment system of the applied axis  
 [Valid data range] 0 or positive 9 digit of minimum unit of data (refer to the standard parameter setting table (B))  
 (When the increment system is IS-B, 0.0 to +999999.999)  
 Set the length (L) of the tail stock.

**NOTE**

Whether to specify this parameter by using a diameter value or radius value depends on whether the corresponding axis is based on diameter specification or radius specification.

|      |                              |
|------|------------------------------|
| 1342 | Diameter of a tail stock (D) |
|------|------------------------------|

- [Input type] Parameter input  
 [Data type] Real path  
 [Unit of data] mm, inch (input unit)  
 [Min. unit of data] Depend on the increment system of the applied axis



[Valid data range] 0 or positive 9 digit of minimum unit of data (refer to the standard parameter setting table (B))  
 (When the increment system is IS-B, 0.0 to +999999.999)  
 Set the diameter (D) of the tail stock.

**NOTE**

Specify this parameter by using a diameter value at all times.

1343

Length of a tail stock (L1)

[Input type] Parameter input

[Data type] Real path

[Unit of data] mm, inch (input unit)

[Min. unit of data] Depend on the increment system of the applied axis

[Valid data range] 0 or positive 9 digit of minimum unit of data (refer to the standard parameter setting table (B))  
 (When the increment system is IS-B, 0.0 to +999999.999)  
 Set the length (L1) of the tail stock.

**NOTE**

Whether to specify this parameter by using a diameter value or radius value depends on whether the corresponding axis is based on diameter specification or radius specification.

1344

Diameter of a tail stock (D1)

[Input type] Parameter input

[Data type] Real path

[Unit of data] mm, inch (input unit)

[Min. unit of data] Depend on the increment system of the applied axis

[Valid data range] 0 or positive 9 digit of minimum unit of data (refer to the standard parameter setting table (B))  
 (When the increment system is IS-B, 0.0 to +999999.999)  
 Set the diameter (D1) of the tail stock.

**NOTE**

Specify this parameter by using a diameter value at all times.

1345

Length of a tail stock (L2)

[Input type] Parameter input

[Data type] Real path

[Unit of data] mm, inch (input unit)

[Min. unit of data] Depend on the increment system of the applied axis

[Valid data range] 0 or positive 9 digit of minimum unit of data (refer to the standard parameter setting table (B))  
 (When the increment system is IS-B, 0.0 to +999999.999)  
 Set the length (L2) of the tail stock.

**NOTE**  
Whether to specify this parameter by using a diameter value or radius value depends on whether the corresponding axis is based on diameter specification or radius specification.

|      |                               |
|------|-------------------------------|
| 1346 | Diameter of a tail stock (D2) |
|------|-------------------------------|

[Input type] Parameter input  
 [Data type] Real path  
 [Unit of data] mm, inch (input unit)  
 [Min. unit of data] Depend on the increment system of the applied axis  
 [Valid data range] 0 or positive 9 digit of minimum unit of data (refer to the standard parameter setting table (B))  
 (When the increment system is IS-B, 0.0 to +999999.999)  
 Set the diameter (D2) of the tail stock.

**NOTE**  
Specify this parameter by using a diameter value at all times.

|      |                               |
|------|-------------------------------|
| 1347 | Diameter of a tail stock (D3) |
|------|-------------------------------|

[Input type] Parameter input  
 [Data type] Real path  
 [Unit of data] mm, inch (input unit)  
 [Min. unit of data] Depend on the increment system of the applied axis  
 [Valid data range] 0 or positive 9 digit of minimum unit of data (refer to the standard parameter setting table (B))  
 (When the increment system is IS-B, 0.0 to +999999.999)  
 Set the diameter (D3) of the tail stock.

**NOTE**  
Specify this parameter by using a diameter value at all times.

|      |                                   |
|------|-----------------------------------|
| 1348 | Z coordinate of a tail stock (TZ) |
|------|-----------------------------------|

[Input type] Parameter input  
 [Data type] Real path  
 [Unit of data] mm, inch (input unit)  
 [Min. unit of data] Depend on the increment system of the applied axis  
 [Valid data range] 9 digit of minimum unit of data (refer to standard parameter setting table (A))  
 (When the increment system is IS-B, -999999.999 to +999999.999)  
 Set the tail stock position (Z coordinate) in the workpiece coordinate system.

**NOTE**  
Whether to specify this parameter by using a diameter value or radius value depends on whether the corresponding axis is based on diameter specification or radius specification.

|      |    |    |    |     |    |    |     |    |
|------|----|----|----|-----|----|----|-----|----|
|      | #7 | #6 | #5 | #4  | #3 | #2 | #1  | #0 |
| 1401 |    |    |    | RF0 |    |    | LRP |    |

[Input type] Parameter input  
 [Data type] Bit path

**#1 LRP** Positioning (G00)

0: Positioning is performed with non-linear type positioning so that the tool moves along each axis independently at rapid traverse.

1: Positioning is performed with linear interpolation so that the tool moves in a straight line.

When using 3-dimensional coordinate system conversion, set this parameter to 1.

**#4 RF0** When cutting feedrate override is 0% during rapid traverse,

0: The machine tool does not stop moving.

1: The machine tool stops moving.

|             |            |           |           |            |           |           |           |           |
|-------------|------------|-----------|-----------|------------|-----------|-----------|-----------|-----------|
|             | <b>#7</b>  | <b>#6</b> | <b>#5</b> | <b>#4</b>  | <b>#3</b> | <b>#2</b> | <b>#1</b> | <b>#0</b> |
| <b>1403</b> | <b>RTV</b> |           |           | <b>ROC</b> |           |           |           |           |

[Input type] Parameter input

[Data type] Bit path

**#4 ROC** In the threading cycles G92 and G76, rapid traverse override for retraction after threading is finished is:

0: Effective

1: Not effective (Override of 100%)

**#7 RTV** Rapid traverse override while the tool is retracting in threading

0: Rapid traverse override is effective.

1: Rapid traverse override is not effective.

|             |  |
|-------------|--|
| <b>1420</b> | <b>Rapid traverse rate for each axis</b> |
|-------------|--|

[Input type] Parameter input

[Data type] Real axis

[Unit of data] mm/min, inch/min, degree/min (machine unit)

[Min. unit of data] Depend on the increment system of the applied axis

[Valid data range] Refer to the standard parameter setting table (C)  
(When the increment system is IS-B, 0.0 to +999000.0)

Set the rapid traverse rate when the rapid traverse override is 100% for each axis.

|             |  |
|-------------|--|
| <b>1466</b> | <b>Feedrate for retraction in threading cycle G92 or G76</b> |
|-------------|--|

[Input type] Parameter input

[Data type] Real path

[Unit of data] mm/min, inch/min (machine unit)

[Min. unit of data] Depend on the increment system of the reference axis

[Valid data range] Refer to the standard parameter setting table (C)  
(When the increment system is IS-B, 0.0 to +999000.0)

When threading cycle G92 or G76 is specified, retraction is performed after threading.  
Set a feedrate for this retraction.

|   |
|---|
| <p> <b>WARNING</b><br/>When the manual handle interruption is valid, set the same value as the parameter No.1430 to the parameter No.1466.</p> |
|---|

**NOTE**  
 When this parameter is set to 0 or bit 1 (CFR) of parameter No. 1611 is set to 1, the rapid traverse rate set in parameter No. 1420 is used.

|             |    |    |    |    |    |    |      |      |
|-------------|----|----|----|----|----|----|------|------|
|             | #7 | #6 | #5 | #4 | #3 | #2 | #1   | #0   |
| <b>1610</b> |    |    |    |    |    |    | CTBx | CTLx |

[Input type] Parameter input  
 [Data type] Bit axis

- #0 **CTLx** Acceleration/deceleration in cutting feed or dry run during cutting feed  
 0: Exponential acceleration/deceleration is applied.  
 1: Linear acceleration/deceleration after interpolation is applied.
  
- #1 **CTBx** Acceleration/deceleration in cutting feed or dry run during cutting feed  
 0: Exponential acceleration/deceleration or linear acceleration/ deceleration is applied. (depending on the setting in bit 0 (CTLx) of parameter No. 1610)  
 1: Bell-shaped acceleration/deceleration is applied.

|             |    |    |    |    |    |    |    |     |
|-------------|----|----|----|----|----|----|----|-----|
|             | #7 | #6 | #5 | #4 | #3 | #2 | #1 | #0  |
| <b>1611</b> |    |    |    |    |    |    |    | CFR |

[Input type] Parameter input  
 [Data type] Bit path

- #0 **CFR** For retraction after threading in the threading cycles G92 and G76:  
 0: The type of acceleration/deceleration after interpolation for threading is used together with the threading time constant (parameter No. 1626) and FL rate (parameter No. 1627).  
 1: The type of acceleration/deceleration after interpolation for rapid traverse is used together with the rapid traverse time constant.

**NOTE**  
 If this parameter is set to 1, a check is made before a retraction to see that the specified feedrate has become 0 (the delay in acceleration/deceleration has become 0). For retraction, the rapid traverse rate (parameter No. 1420) is used, regardless of the setting of parameter No. 1466. When this parameter is set to 0, parameter No. 1466 is used as the feedrate for retraction. As acceleration/deceleration used for retraction, only acceleration/deceleration after interpolation is used. Rapid traverse acceleration/deceleration before interpolation and optimum torque acceleration/deceleration are disabled.

|             |   |
|-------------|---|
| <b>1626</b> | Acceleration/deceleration time constant in threading cycles for each axis |
|-------------|---|

[Input type] Parameter input  
 [Data type] Word axis  
 [Unit of data] msec  
 [Valid data range] 0 to 4000

Set a time constant for acceleration/deceleration after interpolation in the threading cycles G92 and G76 for each axis.

|             |  |
|-------------|--|
| <b>1627</b> | <b>FL rate for acceleration/deceleration in threading cycles for each axis</b> |
|-------------|--|

[Input type] Parameter input  
 [Data type] Real axis  
 [Unit of data] mm/min, inch/min, degree/min (machine unit)  
 [Min. unit of data] Depend on the increment system of the applied axis  
 [Valid data range] Refer to the standard parameter setting table (C)  
 (When the increment system is IS-B, 0.0 to +999000.0)  
 Set an FL rate for acceleration/deceleration after interpolation in the threading cycles G92 and G76 for each axis. Set 0 at all times except in a special case.

|             |  |
|-------------|--|
| <b>3032</b> | <b>Allowable number of digits for the T code</b> |
|-------------|--|

[Input type] Parameter input  
 [Data type] Byte path  
 [Valid data range] 1 to 8  
 Set the allowable numbers of digits for the T code.  
 When 0 is set, the allowable number of digits is assumed to be 8.

|             |           |           |             |           |           |           |           |           |
|-------------|-----------|-----------|-------------|-----------|-----------|-----------|-----------|-----------|
| <b>3115</b> | <b>#7</b> | <b>#6</b> | <b>#5</b>   | <b>#4</b> | <b>#3</b> | <b>#2</b> | <b>#1</b> | <b>#0</b> |
|             |           |           | <b>APLx</b> |           |           |           |           |           |

[Input type] Parameter input  
 [Data type] Bit axis

**#5 APLx** When the active offset value modification mode based on manual feed is selected, the relative position display is automatically:  
 0: Not preset.  
 1: Preset.  
 Use this parameter when returning a modified offset value to the original value before modification in the active offset value modification mode based on manual feed. The offset value can be returned to the original value by making a movement on the axis by manual feed so that the relative position display (counter) indicates the position 0.

|             |           |           |            |           |           |           |            |            |
|-------------|-----------|-----------|------------|-----------|-----------|-----------|------------|------------|
| <b>3290</b> | <b>#7</b> | <b>#6</b> | <b>#5</b>  | <b>#4</b> | <b>#3</b> | <b>#2</b> | <b>#1</b>  | <b>#0</b>  |
|             |           |           | <b>GOF</b> |           |           |           | <b>GOF</b> | <b>WOF</b> |

[Input type] Parameter input  
 [Data type] Bit path

**#0 WOF** Setting the tool offset value (tool wear offset) by MDI key input is:  
 0: Not disabled.  
 1: Disabled. (With parameters Nos. 3294 and 3295, set the offset number range in which updating the setting is to be disabled.)

**NOTE**  
 The tool offset set in the parameter WOF is followed even if geometric compensation and wear compensation are not specified.

**#1 GOF** Setting the tool geometry offset value by MDI key input is:  
 0: Not disabled.  
 1: Disabled. (With parameters Nos. 3294 and 3295, set the offset number range in which updating the setting is to be disabled.)

**#5 GO2** Setting the second geometric tool offset value by MDI key input is:  
 0: Disabled.  
 1: Not disabled.

|             |  |
|-------------|--|
| <b>3294</b> | <b>Start number of tool offset values whose input by MDI is disabled</b>                   |
| <b>3295</b> | <b>Number of tool offset values (from the start number) whose input by MDI is disabled</b> |

[Input type] Parameter input  
 [Data type] Word path  
 [Valid data range] 0 to 999

When the modification of tool offset values by MDI key input is to be disabled using bits 0 (WOF) and 1 (GOF) of parameter No. 3290, parameters Nos. 3294 and 3295 are used to set the range where such modification is disabled. In parameter No. 3294, set the offset number of the start of tool offset values whose modification is disabled. In parameter No. 3295, set the number of such values. In the following cases, however, none of the tool offset values may be modified:

- When 0 or a negative value is set in parameter No. 3294
- When 0 or a negative value is set in parameter No. 3295
- When a value greater than the maximum tool offset number is set in parameter No. 3294

In the following case, a modification to the values ranging from the value set in parameter No. 3294 to the maximum tool offset number is disabled:

- When the value of parameter No. 3294 added to the value of parameter No. 3295 exceeds the maximum tool offset number

When the offset value of a prohibited number is input through the MDI unit, the warning "WRITE PROTECT" is issued.

[Example] When the following parameter settings are made, modifications to both of the tool geometry offset values and tool wear offset values corresponding to offset numbers 51 to 60 are disabled:

- Bit 1 (GOF) of parameter No. 3290 = 1 (to disable tool geometry offset value modification)
- Bit 0 (WOF) of parameter No. 3290 = 1 (to disable tool wear offset value modification)
- Parameter No. 3294 = 51
- Parameter No. 3295 = 10

If the setting of bit 0 (WOF) of parameter No. 3290 is set to 0 without modifying the other parameter settings above, tool geometry offset value modification only is disabled, and tool wear offset value modification is enabled.

|             |            |            |           |           |           |           |           |            |
|-------------|------------|------------|-----------|-----------|-----------|-----------|-----------|------------|
| <b>3401</b> | <b>#7</b>  | <b>#6</b>  | <b>#5</b> | <b>#4</b> | <b>#3</b> | <b>#2</b> | <b>#1</b> | <b>#0</b>  |
|             | <b>GSC</b> | <b>GSB</b> |           |           |           |           |           | <b>DPI</b> |

[Input type] Parameter input  
 [Data type] Bit path

**#0 DPI** When a decimal point is omitted in an address that can include a decimal point  
 0: The least input increment is assumed. (Normal decimal point input)  
 1: The unit of mm, inches, degree, or second is assumed. (Pocket calculator type decimal point input)

#6 **GSB** The G code system is set.

#7 **GSC**

| GSC | GSB | G code          |
|-----|-----|-----------------|
| 0   | 0   | G code system A |
| 0   | 1   | G code system B |
| 1   | 0   | G code system C |

|      |     |     |    |    |     |    |    |     |
|------|-----|-----|----|----|-----|----|----|-----|
|      | #7  | #6  | #5 | #4 | #3  | #2 | #1 | #0  |
| 3402 | G23 | CLR |    |    | G91 |    |    | G01 |

[Input type] Parameter input

[Data type] Bit path

#0 **G01** G01 Mode entered when the power is turned on or when the control is cleared

- 0: G00 mode (positioning)
- 1: G01 mode (linear interpolation)

#3 **G91** When the power is turned on or when the control is cleared

- 0: G90 mode (absolute programming)
- 1: G91 mode (incremental programming)

#6 **CLR** Reset button on the MDI unit, external reset signal, reset and rewind signal, and emergency stop signal

- 0: Cause reset state.
- 1: Cause clear state.

For the reset and clear states, refer to Appendix, "SETTINGS AT POWER-ON, IN THE CLEAR STATE, OR IN THE RESET STATE" in the OPERATOR'S MANUAL (Common to Lathe System/Machining Center System).

#7 **G23** When the power is turned on

- 0: G22 mode (stored stroke check on)
- 1: G23 mode (stored stroke check off)

|      |    |    |     |     |     |    |    |    |
|------|----|----|-----|-----|-----|----|----|----|
|      | #7 | #6 | #5  | #4  | #3  | #2 | #1 | #0 |
| 3405 |    |    | DDP | CCR | G36 |    |    |    |

[Input type] Parameter input

[Data type] Bit path

#3 **G36** As a G code to be used with the automatic tool offset function is:

- 0: G36/G37 is used.
- 1: G37.1/G37.2/G37.3 is used.

**NOTE**  
If it is necessary to perform circular threading (counterclockwise), set this parameter to 1.

#4 **CCR** Addresses used for chamfering

- 0: Address is "I", "J", or "K".  
In direct drawing dimension programming, addresses "C", "R", and "A" (with comma) are used in stead of "C", "R", and "A".
- 1: Address is "C".  
Addresses used for direct drawing dimension programming are "C", "R", and "A" without comma.

**NOTE**  
 If this bit (CCR) is set to 0, the function for changing the compensation direction by specifying I, J, or K in a G01 block in the cutter compensation/ tool nose radius compensation mode cannot be used.  
 If this bit (CCR) is set to 1 when address C is used as an axis name, the chamfer function cannot be used.

**#5 DDP** Angle commands by direct drawing dimension programming  
 0: Normal specification  
 1: A supplementary angle is given.

|             |    |    |    |    |    |    |    |            |
|-------------|----|----|----|----|----|----|----|------------|
|             | #7 | #6 | #5 | #4 | #3 | #2 | #1 | #0         |
| <b>3453</b> |    |    |    |    |    |    |    | <b>CRD</b> |

[Input type] Setting input  
 [Data type] Bit path

**#0 CRD** If the functions of chamfering or corner R and direct drawing dimension programming are both enabled,  
 0: Chamfering or corner R is enabled.  
 1: Direct drawing dimension programming is enabled.  
 Specify which function is used when both the chamfering/corner R function and the drawing dimension programming function are enabled.

|             |            |    |    |    |    |    |    |    |
|-------------|------------|----|----|----|----|----|----|----|
|             | #7         | #6 | #5 | #4 | #3 | #2 | #1 | #0 |
| <b>3458</b> | <b>CRC</b> |    |    |    |    |    |    |    |

[Input type] Setting input  
 [Data type] Bit path

**#7 CRC** In Direct drawing dimension programming function, when a minus value is commanded as a chamfering value / corner R value:  
 0: Alarm PS0055, "MISSING MOVE VALUE IN CHF/CNR" is issued.  
 1: Alarm is not issued. A minus value is converted to a plus value.

|             |    |            |    |    |    |    |    |    |
|-------------|----|------------|----|----|----|----|----|----|
|             | #7 | #6         | #5 | #4 | #3 | #2 | #1 | #0 |
| <b>5001</b> |    | <b>EVO</b> |    |    |    |    |    |    |

[Input type] Parameter input  
 [Data type] Bit path

**#6 EVO** If a tool compensation value modification is made for tool length compensation A or tool length compensation B in the offset mode (G43 or G44):  
 0: The new value becomes valid in a block where G43, G44, or an H code is specified next.  
 1: The new value becomes valid in a block where buffering is performed next.

|             |            |            |            |            |            |            |            |    |
|-------------|------------|------------|------------|------------|------------|------------|------------|----|
|             | #7         | #6         | #5         | #4         | #3         | #2         | #1         | #0 |
| <b>5002</b> | <b>WNP</b> | <b>LWM</b> | <b>LGC</b> | <b>LGT</b> | <b>ETC</b> | <b>LWT</b> | <b>LGN</b> |    |

[Input type] Parameter input  
 [Data type] Bit path



- #1 **LGN** Geometry offset number of tool offset  
 0: Is the same as wear offset number  
 1: Specifies the geometry offset number by the tool selection number

**NOTE**

This parameter is valid when the tool geometry/wear compensation is enabled (bit 6 (NGW) of parameter No.8136 is 0).

- #2 **LWT** Tool wear compensation is performed by:  
 0: Moving the tool.  
 1: Shifting the coordinate system.

**NOTE**

This parameter is valid when the tool geometry/wear compensation is enabled (bit 6 (NGW) of parameter No.8136 is 0).

- #3 **ETC** When a T-code command is two digits or shorter, the T code is:  
 0: Not extended.  
 1: Extended.  
 When this parameter is 1, two-digit or shorter T-code commands are extended. (Three-digit or longer T-code commands are not extended.) The value after extension is determined by the setting of the number of digits in the offset number in T-code commands (parameter No. 5028).

| Parameter No.<br>5028 | Number of digits after<br>extension | Sample extension                              |
|-----------------------|-------------------------------------|---|
| 1                     | Extended to two digits              | Before extension: T1 → After extension: T11   |
| 2                     | Extended to four digits             | Before extension: T1 → After extension: T0101 |
| 3 or greater          | Not extended                        |   |

[Example]

- Parameter No. 5028 : 2
- Parameter No. 3032 : 4 (Allowable number of digits in T code)
 

|                  |   |  |
|------------------|---|--|
| Before extension | → | After extension                                  |
| T1               | → | T0101 (1-digit command is extended to 4 digits.) |
| T12              | → | T1212 (2-digit command is extended to 4 digits.) |
| T112             | → | T112 (Not extended)                              |
| T1122            | → | T1122 (Not extended)                             |

**NOTE**

- 1 The setting of the allowable number of digits in T code (parameter No. 3032) indicates the number of digits in a specified command (before being extended). If the number of digits in the command exceeds the allowable number of digits in T code, the alarm PS0003, "TOO MANY DIGIT" is issued.
- 2 This parameter is dedicated to the lathe system. Tool change is available with the turret type setting (bit 3 (TCT) of parameter No. 5040 = 0).
- 3 If the number of digits in the offset number in a T-code command (parameter No. 5028) is set to 0, the value after extension is determined by the number of digits in the number of tool compensation values (parameter No. 5024).
- 4 Common variable #149 for calling a T-code macro is set to the pre-extension value.

- #4 LGT** Tool geometry compensation  
 0: Compensated by the shift of the coordinate system  
 1: Compensated by the tool movement

**NOTE**

This parameter is valid when the tool geometry/wear compensation is enabled (bit 6 (NGW) of parameter No.8136 is 0).

- #5 LGC** When tool geometry compensation is based on coordinate shifting, the tool geometry offset is:  
 0: Not canceled by a command with offset number 0.  
 1: Canceled by a command with offset number 0.

**NOTE**

This parameter is valid when the tool geometry/wear compensation is enabled (bit 6 (NGW) of parameter No.8136 is 0).

- #6 LWM** Tool offset operation based on tool movement is performed:  
 0: In a block where a T code is specified.  
 1: Together with a command for movement along an axis.

- #7 WNP** Imaginary tool tip number used for tool nose radius compensation, when the tool geometry/wear compensation function is equipped, is the number specified by:  
 0: Geometry offset number  
 1: Wear offset number

|      | #7  | #6 | #5 | #4 | #3 | #2 | #1  | #0  |
|------|-----|----|----|----|----|----|-----|-----|
| 5003 | TGC |    |    |    |    |    | SUV | SUP |

[Input type] Parameter input

[Data type] Bit path

#0 SUP

#1 SUV These bits are used to specify the type of startup/cancellation of tool radius - tool nose radius compensation.

| SUV | SUP | Type   | Operation  |
|-----|-----|--------|--|
| 0   | 0   | Type A | <p>A compensation vector perpendicular to the block next to the startup block or the block preceding the cancellation block is output.</p> <p>Tool nose radius center path /<br/>Tool center path</p> <p>Programmed path</p>   |
| 0   | 1   | Type B | <p>A compensation vector perpendicular to the startup block or cancellation block and an intersection vector are output.</p> <p>Tool nose radius center path /<br/>Tool center path</p> <p>Programmed path</p>   |
| 1   | 0   | Type C | <p>When the startup block or cancellation block specifies no movement operation, the tool is shifted by the cutter compensation amount in a direction perpendicular to the block next to the startup or the block before cancellation block.</p> <p>Tool nose radius center path /<br/>Tool center path</p> <p>Programmed path</p> <p>When the block specifies movement operation, the type is set according to the SUP setting; if SUP is 0, type A is set, and if SUP is 1, type B is set.</p> |

**NOTE**  
When SUV,SUP = 0,1 (type B), an operation equivalent to that of FS16i-T is performed.

#7 TGC A tool geometry offset based on a coordinate shift is:

0: Not canceled by reset.

1: Canceled by reset.

**NOTE**  
This parameter is valid when the tool geometry/wear compensation is enabled (bit 6 (NGW) of parameter No.8136 is 0).

|      |    |    |    |    |     |    |    |    |
|------|----|----|----|----|-----|----|----|----|
|      | #7 | #6 | #5 | #4 | #3  | #2 | #1 | #0 |
| 5004 |    |    |    |    | TS1 |    |    |    |

[Input type] Parameter input

[Data type] Bit path

- #3 **TS1** For touch sensor contact detection with the function for direct input of offset value measured B:  
 0: Four-contact input is used.  
 1: One-contact input is used.

**NOTE**  
 For the machining center system, set TS1 to 1.

|      |    |    |     |    |    |     |    |    |
|------|----|----|-----|----|----|-----|----|----|
|      | #7 | #6 | #5  | #4 | #3 | #2  | #1 | #0 |
| 5005 |    |    | QNI |    |    | PRC |    |    |

[Input type] Parameter input  
 [Data type] Bit path

- #2 **PRC** For direct input of a tool offset value or workpiece coordinate system shift amount:  
 0: The position record signal PRC <Gn040.6> is not used.  
 1: The position record signal PRC <Gn040.6> is used.

- #5 **QNI** With the tool length measurement function or the function for direct input of offset value measured B, a tool compensation number is selected by:  
 0: Operation through the MDI unit by the operator (selection based on cursor operation).  
 1: Signal input from the PMC.

|      |    |    |    |    |     |    |    |    |
|------|----|----|----|----|-----|----|----|----|
|      | #7 | #6 | #5 | #4 | #3  | #2 | #1 | #0 |
| 5006 |    |    |    |    | LVC |    |    |    |

[Input type] Parameter input  
 [Data type] Bit

- #3 **LVC** A tool offset (geometry/wear) based on a tool movement and wear offset based on a coordinate shift are:  
 0: Not canceled by reset.  
 1: Canceled by reset.

|      |    |    |    |    |     |    |     |    |
|------|----|----|----|----|-----|----|-----|----|
|      | #7 | #6 | #5 | #4 | #3  | #2 | #1  | #0 |
| 5008 |    |    |    |    | CNV |    | CNC |    |

[Input type] Parameter input  
 [Data type] Bit path

- #1 **CNC**
- #3 **CNV** These bits are used to select an interference check method in the tool radius - tool nose radius compensation mode.

| CNV | CNC | Operation   |
|-----|-----|---|
| 0   | 0   | Interference check is enabled. The direction and the angle of an arc are checked. |
| 0   | 1   | Interference check is enabled. Only the angle of an arc is checked.               |
| 1   | -   | Interference check is disabled.   |

For the operation taken when the interference check shows the occurrence of an reference (overcutting) , see the description of bit 5 (CAV) of parameter No. 19607.

**NOTE**  
 Checking of only the direction cannot be set.

|             |   |
|-------------|---|
| <b>5010</b> | <b>Limit for ignoring the small movement resulting from tool radius - tool nose radius compensation</b> |
|-------------|---|

[Input type] Setting input  
 [Data type] Real path  
 [Unit of data] mm, inch (input unit)  
 [Min. unit of data] Depend on the increment system of the reference axis  
 [Valid data range] 9 digit of minimum unit of data (refer to standard parameter setting table (A))  
 (When the increment system is IS-B, -999999.999 to +999999.999)  
 When the tool moves around a corner in cutter compensation or tool nose radius compensation mode, the limit for ignoring the small travel amount resulting from compensation is set. This limit eliminates the interruption of buffering caused by the small travel amount generated at the corner and any change in feedrate due to the interruption.

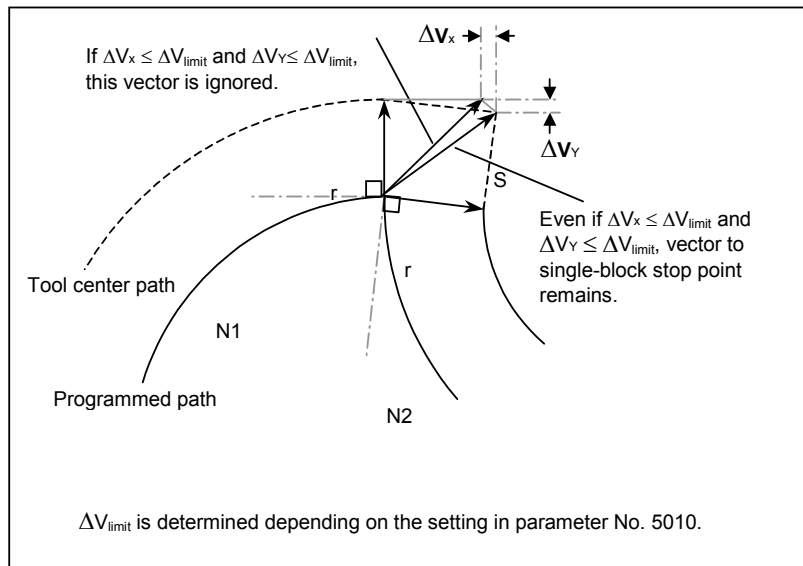

|             |  |
|-------------|--|
| <b>5020</b> | <b>Tool offset number used with the function for direct input of offset value measured B</b> |
|-------------|--|

[Input type] Parameter input  
 [Data type] Word path  
 [Valid data range] 0 to number of tool compensation values  
 Set a tool offset number used with the function for direct input of offset value measured B (when a workpiece coordinate system shift amount is set). (Set the tool offset number corresponding to a tool under measurement beforehand.) This parameter is valid when automatic tool offset number selection is not performed (when bit 5 (QNI) of parameter No. 5005 is set to 0).

|             |   |
|-------------|---|
| <b>5024</b> | <b>Number of tool compensation values</b> |
|-------------|---|

**NOTE**  
 When this parameter is set, the power must be turned off before operation is continued.

[Input type] Parameter input  
 [Data type] Word path  
 [Valid data range] 0 to 999  
 Set the maximum allowable number of tool compensation values used for each path.

Ensure that the total number of values set in parameter No. 5024 for the individual paths is within the number of compensation values usable in the entire system. The number of compensation values usable in the entire system depends on the option configuration.

If the total number of values set in parameter No. 5024 for the individual paths exceeds the number of compensation values usable in the entire system, or 0 is set in parameter No. 5024 for all paths, the number of compensation values usable for each path is a value obtained by dividing the number of compensation values usable in the entire system by the number of paths.

Tool compensation values as many as the number of compensation values used for each path are displayed on the screen. If tool compensation numbers more than the number of compensation values usable for each path are specified, an alarm is issued.

For example, 200 tool compensation sets are used, 120 sets may be allocated to path 1, 80 sets to path 2. All of 200 sets need not be used.

|             |  |
|-------------|--|
| <b>5028</b> | <b>Number of digits of an offset number used with a T code command</b> |
|-------------|--|

[Input type] Parameter input

[Data type] Byte path

[Valid data range] 0 to 4

Specify the number of digits of a T code portion that is used for a tool offset number (wear offset number when the tool geometry/wear compensation function is used).

When 0 is set, the number of digits is determined by the number of tool compensation values.

When the number of tool compensation values is 1 to 9: Lower 1 digit

When the number of tool compensation values is 10 to 99: Lower 2 digits

When the number of tool compensation values is 100 to 999: Lower 3 digits

[Example] When an offset number is specified using the lower 2 digits of a T code, set 2 in parameter No. 5028.

Txxxxxx yy

xxxxxx : Tool selection

yy : Tool offset number

In tool management function, set 4 in this parameter to set 4-digit number in parameter No.13265.

**NOTE**  
A value longer than the setting of parameter No. 3032 (allowable number of digits of a T code) cannot be set.

|             |           |           |           |           |           |           |           |           |
|-------------|-----------|-----------|-----------|-----------|-----------|-----------|-----------|-----------|
| <b>5040</b> | <b>#7</b> | <b>#6</b> | <b>#5</b> | <b>#4</b> | <b>#3</b> | <b>#2</b> | <b>#1</b> | <b>#0</b> |
|             | NO4       |           |           | TLG       | TCT       |           |           |           |

[Input type] Parameter input

[Data type] Bit path

**#3 TCT** The tool change method is based on:

0: Turret rotation. (Tool change operation is performed with a T command only.)

With a T command, an auxiliary function and tool offset operation are performed.

1: Automatic tool changer (ATC).

(Tool change operation is performed with an M command (such as M06)).

With a T command, an auxiliary function only is performed.

This parameter is valid with a lathe system only.

**⚠ WARNING**  
 Before changing the setting of this parameter, cancel the offset. If the setting is changed while the offset is applied, the subsequent offset operation may not be performed correctly or an alarm PS0368, "OFFSET REMAIN AT OFFSET COMMAND" occurs.

**#4 TLG** When tool change operation is performed with the automatic tool changer (when bit 3 (TCT) of parameter No. 5040 is set to 1), tool offset operation is specified by:

0: G43.7.

At this time, G43 and G44 function as G codes for tool length compensation.

1: G43.

At this time, G43.7 and G44.7 function as G codes for tool length compensation.

**#7 NO4** 4th axis offset function is:

0: Used.

1: Not used.

|             |           |           |           |           |            |            |            |            |
|-------------|-----------|-----------|-----------|-----------|------------|------------|------------|------------|
|             | <b>#7</b> | <b>#6</b> | <b>#5</b> | <b>#4</b> | <b>#3</b>  | <b>#2</b>  | <b>#1</b>  | <b>#0</b>  |
| <b>5042</b> |           |           |           |           | <b>OFE</b> | <b>OFD</b> | <b>OFC</b> | <b>OFA</b> |

[Input type] Parameter input

[Data type] Bit path

**NOTE**  
 When this parameter is set, the power must be turned off before operation is continued.

**#0 OFA**

**#1 OFC**

**#2 OFD**

**#3 OFE** These bits are used to specify the increment system and valid data range of a tool offset value.

**For metric input**

| OFE | OFD | OFC | OFA | Unit       | Valid data range |
|-----|-----|-----|-----|------------|------------------|
| 0   | 0   | 0   | 1   | 0.01mm     | ±9999.99mm       |
| 0   | 0   | 0   | 0   | 0.001mm    | ±9999.999mm      |
| 0   | 0   | 1   | 0   | 0.0001mm   | ±9999.9999mm     |
| 0   | 1   | 0   | 0   | 0.00001mm  | ±9999.99999mm    |
| 1   | 0   | 0   | 0   | 0.000001mm | ±999.999999mm    |

**For inch input**

| OFE | OFD | OFC | OFA | Unit          | Valid data range |
|-----|-----|-----|-----|---------------|------------------|
| 0   | 0   | 0   | 1   | 0.001inch     | ±999.999inch     |
| 0   | 0   | 0   | 0   | 0.0001inch    | ±999.9999inch    |
| 0   | 0   | 1   | 0   | 0.00001inch   | ±999.99999inch   |
| 0   | 1   | 0   | 0   | 0.000001inch  | ±999.999999inch  |
| 1   | 0   | 0   | 0   | 0.0000001inch | ±99.9999999inch  |

|             |  |
|-------------|--|
| <b>5044</b> | <b>Axis number for which 4th-axis offset is used</b> |
|-------------|--|

**NOTE**  
When this parameter is set, the power must be turned off before operation is continued.

[Input type] Parameter input  
 [Data type] Byte path  
 [Valid data range] 0, 1 to number of controlled axes  
 Set the number of an axis for which the 4th-axis offset is used.  
 When a value ranging from 1 to the number of controlled axes is set in this parameter, the 4th-axis offset is applied to the set axis number. If 0 or a value beyond the valid data range is set, the 4th-axis offset is not used. For the basic two axes X and Z, the standard tool offsets are used, so the 4th-axis offset cannot be used. When the axis set for the Y-axis offset function is set in this parameter, the Y-axis offset is used for the axis, and the 4th-axis offset is not used.

|             |  |
|-------------|--|
| <b>5045</b> | <b>Axis number for which 5th-axis offset is used</b> |
|-------------|--|

**NOTE**  
When this parameter is set, the power must be turned off before operation is continued.

[Input type] Parameter input  
 [Data type] Byte path  
 [Valid data range] 0, 1 to number of controlled axes  
 Set the number of an axis for which the 5th-axis offset is used.  
 When a value ranging from 1 to the number of controlled axes is set in this parameter, the 5th-axis offset is applied to the set axis number. If 0 or a value beyond the valid data range is set, the 5th-axis offset is not used. For the basic two axes X and Z, the standard tool offsets are used, so the 5th-axis offset cannot be used. When the axis set for the Y-axis offset function is set in this parameter, the Y-axis offset is used for the axis, and the 5th-axis offset is not used.  
 When settings are made so that both the 5th-axis offset and 4th-axis offset apply to the same axis, only the 4th-axis offset is used, and the 5th-axis offset is not used.

|             |           |           |           |           |           |            |           |            |
|-------------|-----------|-----------|-----------|-----------|-----------|------------|-----------|------------|
|             | <b>#7</b> | <b>#6</b> | <b>#5</b> | <b>#4</b> | <b>#3</b> | <b>#2</b>  | <b>#1</b> | <b>#0</b>  |
| <b>5101</b> |           |           |           |           |           | <b>RTR</b> |           | <b>FXY</b> |

[Input type] Parameter input  
 [Data type] Bit path

- #0 FXY** The drilling axis in the drilling canned cycle is:
  - 0: In case of the Drilling canned cycle:  
Z-axis at all times.
  - 1: Axis selected by the program

**NOTE**  
This parameter is valid only for the drilling canned cycle in the Series 10/11 format.

- #2 RTR** G83 and G87
  - 0: Specify a high-speed peck drilling cycle
  - 1: Specify a peck drilling cycle



|      | #7  | #6  | #5 | #4 | #3  | #2  | #1 | #0 |
|------|-----|-----|----|----|-----|-----|----|----|
| 5102 | RDI | RAB |    |    | F16 | QSR |    |    |

[Input type] Parameter input

[Data type] Bit path

**#2 QSR** Before a multiple repetitive canned cycle (G70 to G73) is started, a check to see if the program contains a block that has the sequence number specified in address Q is:

0: Not made.

1: Made.

When 1 is set in this parameter and the sequence number specified in address Q is not found, the alarm PS0063, "THE BLOCK OF A SPECIFIED SEQUENCE NUMBER IS NOT FOUND" is issued and the canned cycle is not executed.

**#3 F16** When the Series 10/11 format is used (with bit 1 (FCV) of parameter No.0001 set to 1), a canned drilling cycle is specified using :

0: Series 15 format

1: Series 16 format. However, the number of repetitions is specified using address L.

**#6 RAB** When a canned drilling cycle using the Series 10/11 format is specified (with bit 1 (FCV) of parameter No. 0001 set to 1 and bit 3 (F16) of parameter No. 5102 set to 0), address R specifies:

0: Increment command.

1: Absolute command with G code system A. With G code system B or C, G90 and G91 are followed.

**#7 RDI** When a canned drilling cycle using the Series 10/11 format is specified (with bit 1 (FCV) of parameter No. 0001 set to 1 and bit 3 (F16) of parameter No. 5102 set to 0), address R is based on:

0: Radius specification.

1: Diameter/radius specification of the drilling axis.

|      | #7 | #6  | #5 | #4 | #3 | #2  | #1 | #0 |
|------|----|-----|----|----|----|-----|----|----|
| 5104 |    | PCT |    |    |    | FCK |    |    |

[Input type] Parameter input

[Data type] Bit path

**#2 FCK** In a multiple repetitive canned cycle (G71, G72), the machining profile is:

0: Not checked.

1: Checked.

The target figure specified by G71 or G72 is checked for the following before machining operation:

- If the start point of the canned cycle is less than the maximum value of the machining profile even when the plus sign is specified for a finishing allowance, the alarm PS0322, "FINISHING SHAPE WHICH OVER OF STARTING POINT" is issued.
- If the start point of the canned cycle is greater than the minimum value of the machining profile even when the minus sign is specified for a finishing allowance, the alarm PS0322 is issued.
- If an unmonotonous command of type I is specified for the axis in the cutting direction, the alarm PS0064, "THE FINISHING SHAPE IS NOT A MONOTONOUS CHANGE(FIRST AXES)" or PS0329, "THE FINISHING SHAPE IS NOT A MONOTONOUS CHANGE(SECOND AXES)" is issued.

- If an unmonotonous command is specified for the axis in the roughing direction, the alarm PS0064 or PS0329 is issued.
- If the program does not include a block that has a sequence number specified by address Q, the alarm PS0063, "THE BLOCK OF A SPECIFIED SEQUENCE NUMBER IS NOT FOUND" is issued. This check is made, regardless of bit 2 (QSR) of parameter No. 5102.
- If a command (G41/G42) on the blank side in tool nose radius compensation is inadequate, the alarm PS0328, "ILLEGAL WORK POSITION IS IN THE TOOL NOSE RADIUS COMPENSATION" is issued.

**#6 PCT** A Q command in a tapping cycle is:

- 0: Disabled.
- 1: Enabled.((High-speed) peck tapping cycle is assumed.)

When this parameter is set and the depth of cut for each time is specified with address Q in a tapping cycle command, a peck tapping cycle is assumed.

In a peck tapping cycle, either a high-speed peck tapping cycle or a peck tapping cycle can be selected by bit 5 (PCP) of parameter No. 5200.

Even when this parameter is set to 1, if Q is not specified or Q0 is specified, normal tapping is performed.

**NOTE**  
 1 Set also parameter No. 5213.  
 2 In rigid tapping, the Q command is valid regardless of the setting of this parameter.

|             |           |           |           |           |            |            |            |            |
|-------------|-----------|-----------|-----------|-----------|------------|------------|------------|------------|
|             | <b>#7</b> | <b>#6</b> | <b>#5</b> | <b>#4</b> | <b>#3</b>  | <b>#2</b>  | <b>#1</b>  | <b>#0</b>  |
| <b>5105</b> |           |           |           |           | <b>M5T</b> | <b>RF2</b> | <b>RF1</b> | <b>SBC</b> |

[Input type] Parameter input

[Data type] Bit path

**#0 SBC** In a drilling canned cycle, chamfer cycle, or corner rounding cycle:

- 0: A single block stop is not performed.
- 1: A single block stop is performed.

**#1 RF1** In a multiple repetitive canned cycle (G71, G72) of type I, roughing is:

- 0: Performed.
- 1: Not performed.

**NOTE**  
 When a roughing allowance ( $\Delta i/\Delta k$ ) is specified using the Series 10/11 program format, roughing is performed, regardless of the setting of this parameter.

**#2 RF2** In a multiple repetitive canned cycle (G71, G72) of type II, roughing is:

- 0: Performed.
- 1: Not performed.

**NOTE**  
 When a roughing allowance ( $\Delta i/\Delta k$ ) is specified using the Series 10/11 program format, roughing is performed, regardless of the setting of this parameter.

- #3 M5T** When the rotation direction of the spindle is changed from forward rotation to reverse rotation or from reserve rotation to forward rotation in a tapping cycle (G84/G88):  
 0: M05 is output before output of M04 or M03.  
 1: M05 is not output before output of M04 or M03.

|             |    |    |    |    |            |            |    |    |
|-------------|----|----|----|----|------------|------------|----|----|
|             | #7 | #6 | #5 | #4 | #3         | #2         | #1 | #0 |
| <b>5106</b> |    |    |    |    | <b>NT2</b> | <b>NT1</b> |    |    |

[Input type] Parameter input  
 [Data type] Bit path

**NOTE**  
 When this parameter is set, the power must be turned off before operation is continued.

- #2 NT1** In the multiple repetitive cycle G71/G72/G73 (G-code system A), when the tool nose radius compensation G40/G41/G42 is commanded in the target figure program:  
 0: The alarm PS0325, “UNAVAILABLE COMMAND IS IN SHAPE PROGRAM” is occurred.  
 1: No alarm is occurred. However, the tool nose radius compensation command in the target figure program is ignored.
- #3 NT2** In the multiple repetitive cycle G70 (G-code system A), when the tool nose radius compensation G40/G41/G42 is commanded in the target figure program:  
 0: The alarm PS0325 is occurred.  
 1: No alarm is occurred. The tool nose radius compensation command is valid.

**NOTE**  
 Make the program by following ways to enable the tool nose radius compensation in the finishing cycle G70 by commanded the tool nose radius compensation in the target figure program.

- The tool nose radius compensation cancel G40 is selected as the modal when the finishing cycle G70 is commanded.
- Command G41/G42 at the first block of the target figure program (commanded by P address).
- Command G40 at the last block of the target figure program (commanded by Q address).

|             |    |    |    |    |            |    |            |            |
|-------------|----|----|----|----|------------|----|------------|------------|
|             | #7 | #6 | #5 | #4 | #3         | #2 | #1         | #0         |
| <b>5108</b> |    |    |    |    | <b>NSP</b> |    | <b>DTP</b> | <b>R16</b> |

[Input type] Parameter input  
 [Data type] Bit path

- #0 **R16** In the cutting up movement of the multiple repetitive cycle G71/G72 (G-code system A) of type II , if there is the block that commands just the movement of the first axis on the plane in the finishing shape:
  - 0: The cutting up movement is executed before the cutting of the first axis on the plane.
  - 1: The cutting up movement is not executed and the cutting is continued along the finishing shape of the first axis on the plane.
  
- #1 **DTP** In the multiple repetitive cycle G71/G72 (G-code system A) of type I , after rough cutting of the finishing shape program is finished, the tool return to the cycle start point:
  - 0: After the tool moves to (cycle start point + distance of the finishing allowance) in order X-axis, Z-axis.
  - 1: Directly from the end point of the finishing program.
  
- #3 **NSP** In the multiple repetitive cycle G71/G72 (G-code system A) of type II , the cutting is executed:
  - 0: By conventional path. (The same cutting path might be executed.)
  - 1: Not to repeat the same cutting path.

|             |   |
|-------------|---|
| <b>5110</b> | <b>M code for C-axis clamping in canned cycles for drilling</b> |
|-------------|---|

[Input type] Parameter input  
 [Data type] 2-word path  
 [Valid data range] 0 to 99999998  
 This parameter sets the M code for C-axis clamping in canned cycles for drilling.

**NOTE**  
 When bit 4 (CME) of parameter No. 5161 is 1, the M code for C-axis clamping for the first pair is assumed.

|             |  |
|-------------|--|
| <b>5111</b> | <b>Dwell time when C-axis unclamping is specified in drilling canned cycle</b> |
|-------------|--|

[Input type] Parameter input  
 [Data type] 2-word path  
 [Valid data range] 0 to 32767  
 [Unit of data]

| Increment system | IS-A | IS-B | IS-C | Unit |
|------------------|------|------|------|------|
|                  | 10   | 1    | 0.1  | msec |

(The increment system does not depend on whether inch input or metric input is used.)

This parameter sets the dwell time when C-axis unclamping is specified in a drilling canned cycle.

|             |   |
|-------------|---|
| <b>5114</b> | <b>Return value of high-speed peck drilling cycle</b> |
|-------------|---|

[Input type] Parameter input  
 [Data type] Real path  
 [Unit of data] mm, inch (input unit)  
 [Min. unit of data] Depend on the increment system of the reference axis

[Valid data range] 9 digit of minimum unit of data (refer to standard parameter setting table (A))  
 (When the increment system is IS-B, -999999.999 to +999999.999)  
 This parameter sets the return value in high-speed peck drilling cycle.

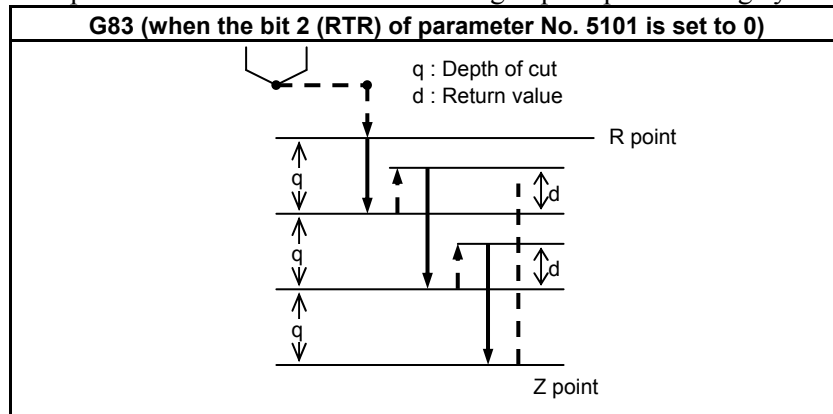

|      |  |
|------|--|
| 5115 | Clearance value in a peck drilling cycle |
|------|--|

[Input type] Parameter input

[Data type] Real path

[Unit of data] mm, inch (input unit)

[Min. unit of data] Depend on the increment system of the reference axis

[Valid data range] 9 digit of minimum unit of data (refer to standard parameter setting table (A))  
 (When the increment system is IS-B, -999999.999 to +999999.999)  
 This parameter sets a clearance value in a peck drilling cycle.

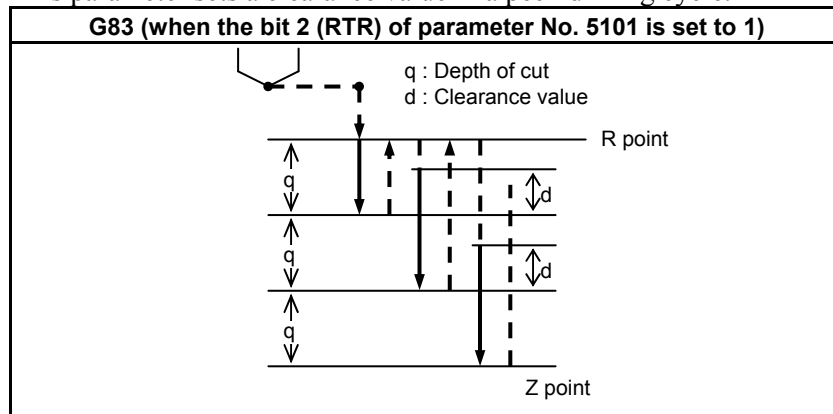

|      |    |    |    |    |    |           |    |    |
|------|----|----|----|----|----|-----------|----|----|
| 5125 | #7 | #6 | #5 | #4 | #3 | #2<br>PRS | #1 | #0 |
|------|----|----|----|----|----|-----------|----|----|

[Input type] Parameter input

[Data type] Bit path

#2 PRS In Pattern repeating cycle G73 (G-code system A), the stop position of single block operation are:  
 0: The end point of each cycles and the end point of each blocks in the finishing shape.  
 1: The end point of each cycles and the end point of escape from the cycle start point.  
 (FS16i compatible specification)

|      |   |
|------|---|
| 5130 | Cutting value (chamfering value) in thread cutting cycles G92 and G76 |
|------|---|

[Input type] Parameter input

[Data type] Byte path

[Unit of data] 0.1

[Valid data range] 0 to 127

This parameter sets a cutting value (chamfering value) in the thread cutting cycle (G76) of a multiple repetitive canned cycle and in the thread cutting cycle (G92) of a canned cycle.

Let L be a lead. Then, a cutting value range from 0.1L to 12.7L is allowed.

To specify a cutting value of 10.0L, for example, specify 100 in this parameter.

**5131**

**Cutting angle in thread cutting cycles G92 and G76**

[Input type] Parameter input

[Data type] Byte path

[Unit of data] Degree

[Valid data range] 1 to 89

This parameter sets a thread cutting angle in a thread cutting cycle (G92/G76).

When 0 is set, an angle of 45 degrees is specified.

**5132**

**Depth of cut in multiple repetitive canned cycles G71 and G72**

[Input type] Parameter input

[Data type] Real path

[Unit of data] mm, inch (input unit)

[Min. unit of data] Depend on the increment system of the reference axis

[Valid data range] 0 or positive 9 digit of minimum unit of data (refer to the standard parameter setting table (B))

(When the increment system is IS-B, 0.0 to +999999.999)

This parameter sets the depth of cut in multiple repetitive canned cycles G71 and G72.

This parameter is not used with the Series 10/11 program format.

**NOTE**

Specify a radius value at all times.

**5133**

**Escape in multiple repetitive canned cycles G71 and G72**

[Input type] Parameter input

[Data type] Real path

[Unit of data] mm, inch (input unit)

[Min. unit of data] Depend on the increment system of the reference axis

[Valid data range] 0 or positive 9 digit of minimum unit of data (refer to the standard parameter setting table (B))

(When the increment system is IS-B, 0.0 to +999999.999)

This parameter sets the escape in multiple repetitive canned cycles G71 and G72.

**NOTE**

Specify a radius value at all times.

**5134**

**Clearance value in multiple repetitive canned cycles G71 and G72**

[Input type] Parameter input

[Data type] Real path

[Unit of data] mm, inch (input unit)

[Min. unit of data] Depend on the increment system of the reference axis

[Valid data range] 0 or positive 9 digit of minimum unit of data (refer to the standard parameter setting table (B))  
 (When the increment system is IS-B, 0.0 to +999999.999)  
 This parameter sets a clearance value up to the cutting feed start point in multiple repetitive canned cycles (G71/G72).

**NOTE**  
 Specify a radius value at all times.

**5135**

**Retraction distance in the multiple repetitive canned cycle G73 (second axis on the plane)**

[Input type] Parameter input  
 [Data type] Real path  
 [Unit of data] mm, inch (input unit)  
 [Min. unit of data] Depend on the increment system of the reference axis  
 [Valid data range] 9 digit of minimum unit of data (refer to standard parameter setting table (A))  
 (When the increment system is IS-B, -999999.999 to +999999.999)  
 This parameter sets a retraction distance along the second axis on the plane in the multiple repetitive canned cycle G73. This parameter is not used with the Series 10/11 program format.

**NOTE**  
 Specify a radius value at all times.

**5136**

**Retraction distance in the multiple repetitive canned cycle G73 (first axis on the plane)**

[Input type] Parameter input  
 [Data type] Real path  
 [Unit of data] mm, inch (input unit)  
 [Min. unit of data] Depend on the increment system of the reference axis  
 [Valid data range] 9 digit of minimum unit of data (refer to standard parameter setting table (A))  
 (When the increment system is IS-B, -999999.999 to +999999.999)  
 This parameter sets a retraction distance along the first axis on the plane in the multiple repetitive canned cycle G73. This parameter is not used with the Series 10/11 program format.

**NOTE**  
 Specify a radius value at all times.

**5137**

**Number of divisions in the multiple repetitive canned cycle G73**

[Input type] Parameter input  
 [Data type] 2-word path  
 [Unit of data] Cycle  
 [Valid data range] 1 to 99999999  
 This parameter sets the number of divisions in the multiple repetitive canned cycle G73.  
 This parameter is not used with the Series 10/11 program format.

**5139**

**Return in multiple repetitive canned cycles G74 and G75**

[Input type] Parameter input  
 [Data type] Real path  
 [Unit of data] mm, inch (input unit)

- [Min. unit of data] Depend on the increment system of the reference axis  
 [Valid data range] 0 or positive 9 digit of minimum unit of data (refer to the standard parameter setting table (B))  
 (When the increment system is IS-B, 0.0 to +999999.999)  
 This parameter sets the return in multiple repetitive canned cycles G74 and G75.

**NOTE**  
Specify a radius value at all times.

5140

Minimum depth of cut in the multiple repetitive canned cycle G76

- [Input type] Parameter input  
 [Data type] Real path  
 [Unit of data] mm, inch (input unit)  
 [Min. unit of data] Depend on the increment system of the reference axis  
 [Valid data range] 0 or positive 9 digit of minimum unit of data (refer to the standard parameter setting table (B))  
 (When the increment system is IS-B, 0.0 to +999999.999)  
 This parameter sets a minimum depth of cut in the multiple repetitive canned cycle G76 so that the depth of cut does not become too small when the depth of cut is constant.

**NOTE**  
Specify a radius value at all times.

5141

Finishing allowance in the multiple repetitive canned cycle G76

- [Input type] Parameter input  
 [Data type] Real path  
 [Unit of data] mm, inch (input unit)  
 [Min. unit of data] Depend on the increment system of the reference axis  
 [Valid data range] 0 or positive 9 digit of minimum unit of data (refer to the standard parameter setting table (B))  
 (When the increment system is IS-B, 0.0 to +999999.999)  
 This parameter sets the finishing allowance in multiple repetitive canned cycle G76.

**NOTE**  
Specify a radius value at all times.

5142

Repetition count of final finishing in multiple repetitive canned cycle G76

- [Input type] Parameter input  
 [Data type] 2-word path  
 [Unit of data] Cycle  
 [Valid data range] 1 to 99999999  
 This parameter sets the number of final finishing cycle repeats in the multiple repetitive canned cycle G76.  
 When 0 is set, only one final finishing cycle is executed.

5143

Tool nose angle in multiple repetitive canned cycle G76

- [Input type] Parameter input  
 [Data type] Byte path  
 [Unit of data] Degree



[Valid data range] 0, 29, 30, 55, 60, 80

This parameter sets the tool nose angle in multiple repetitive canned cycle G76.  
This parameter is not used with the Series 10/11 program format.

|             |   |
|-------------|---|
| <b>5145</b> | <b>Allowable value 1 in multiple repetitive canned cycles G71 and G72</b> |
|-------------|---|

[Input type] Parameter input

[Data type] Real path

[Unit of data] mm, inch (input unit)

[Min. unit of data] Depend on the increment system of the reference axis

[Valid data range] 0 or positive 9 digit of minimum unit of data (refer to the standard parameter setting table (B))

(When the increment system is IS-B, 0.0 to +999999.999)

If a monotonous command of type I or II is not specified for the axis in the roughing direction, the alarm PS0064, "THE FINISHING SHAPE IS NOT A MONOTONOUS CHANGE(FIRST AXES)" or PS0329, "THE FINISHING SHAPE IS NOT A MONOTONOUS CHANGE(SECOND AXES)" is issued. When a program is created automatically, a very small unmonotonous figure may be produced. Set an unsigned allowable value for such an unmonotonous figure. By doing so, G71 and G72 cycles can be executed even in a program including an unmonotonous figure.

[Example] Suppose that a G71 command where the direction of the cutting axis (X-axis) is minus and the direction of the roughing axis (Z-axis) is minus is specified. In such a case, when an unmonotonous command for moving 0.001 mm in the plus direction along the Z-axis is specified in a target figure program, roughing can be performed according to the programmed figure without an alarm by setting 0.001 mm in this parameter.

#### NOTE

A check for a monotonous figure is made at all times during G71 and G72 cycles. A figure (programmed path) is checked. When tool nose radius compensation is performed, a path after compensation is checked. When bit 2 (FCK) of parameter No. 5104 is set to 1, a check is made before G71 or G72 cycle operation. In this case, not a path after tool nose radius compensation but a programmed path is checked.

Note that no alarm is issued when an allowable value is set.

Use a radius value to set this parameter at all times.

|             |   |
|-------------|---|
| <b>5146</b> | <b>Allowable value 2 in multiple repetitive canned cycles G71 and G72</b> |
|-------------|---|

[Input type] Parameter input

[Data type] Real path

[Unit of data] mm, inch (input unit)

[Min. unit of data] Depend on the increment system of the reference axis

[Valid data range] 0 to cut of depth

If a monotonous command of type I is not specified for the axis in the cutting direction, the alarm PS0064, "THE FINISHING SHAPE IS NOT A MONOTONOUS CHANGE(FIRST AXES)" or PS0329, "THE FINISHING SHAPE IS NOT A MONOTONOUS CHANGE(SECOND AXES)" is issued.

When a program is created automatically, a very small unmonotonous figure may be produced. Set an unsigned allowable value for such an unmonotonous figure. By doing so, G71 and G72 cycles can be executed even in a program including an unmonotonous figure.

The allowable value is clamped to the depth of cut specified by a multiple repetitive canned cycle.

[Example] Suppose that a G71 command where the direction of the cutting axis (X-axis) is minus and the direction of the roughing axis (Z-axis) is minus is specified. In such a case, when an unmonotonous command for moving 0.001 mm in the minus direction along the X-axis is specified in a target figure program for moving from the bottom of cutting to the end point, roughing can be performed according to the programmed figure without an alarm by setting 0.001 mm in this parameter.

**NOTE**  
 A check for a monotonous figure is made at all times during G71 and G72 cycles. A figure (programmed path) is checked. When tool nose radius compensation is performed, a path after compensation is checked. When bit 2 (FCK) of parameter No. 5104 is set to 1, a check is made before G71 or G72 cycle operation. In this case, not a path after tool nose radius compensation but a programmed path is checked.  
 Note that no alarm is issued when an allowable value is set.  
 Use a radius value to set this parameter at all times.

|             | #7 | #6 | #5 | #4         | #3 | #2 | #1 | #0 |
|-------------|----|----|----|------------|----|----|----|----|
| <b>5161</b> |    |    |    | <b>CME</b> |    |    |    |    |

[Input type] Parameter input  
 [Data type] Bit path

**#4 CME** For drilling canned cycles, the M code for C-axis clamping/unclamping is set to:  
 0: Value set by parameter No. 5110/value set by parameter No. 5110 + 1.  
 1: Value set by parameter No. 5110/value set by parameter No. 13543 (first pair), or the value set by parameter No. 13544/value set by parameter No. 13545 (second pair).

|             |   |
|-------------|---|
| <b>5176</b> | <b>Grinding axis number in Traverse Grinding Cycle(G71)</b> |
|-------------|---|

[Input type] Parameter input  
 [Data type] Byte path  
 [Valid data range] 0 to Number of controlled axes  
 Set the Grinding axis number of Traverse Grinding Cycle(G71).

|             |  |
|-------------|--|
| <b>5177</b> | <b>Grinding axis number of Traverse direct constant-size Grinding cycle(G72)</b> |
|-------------|--|

[Input type] Parameter input  
 [Data type] Byte path  
 [Valid data range] 0 to Number of controlled axes  
 Set the Grinding axis number of Traverse direct constant-size Grinding cycle(G72).

|             |  |
|-------------|--|
| <b>5178</b> | <b>Grinding axis number of Oscillation Grinding Cycle(G73)</b> |
|-------------|--|

[Input type] Parameter input  
 [Data type] Byte path  
 [Valid data range] 0 to Number of controlled axes  
 Set the Grinding axis number of Oscillation Grinding Cycle(G73).

|             |   |
|-------------|---|
| <b>5179</b> | <b>Grinding axis number of Oscillation Direct Fixed Dimension Grinding Cycle(G74)</b> |
|-------------|---|

[Input type] Parameter input

[Data type] Byte path

[Valid data range] 0 to Number of controlled axes

Set the Grinding axis number of Oscillation Direct Fixed Dimension Grinding Cycle(G74).

|      | #7 | #6  | #5  | #4  | #3 | #2 | #1 | #0  |
|------|----|-----|-----|-----|----|----|----|-----|
| 5200 |    | FHD | PCP | DOV |    |    |    | G84 |

[Input type] Parameter input

[Data type] Bit path

**#0 G84** Method for specifying rigid tapping:

0: An M code specifying the rigid tapping mode is specified prior to the issue of the G84 (or G74) command. (See parameter No. 5210).

1: An M code specifying the rigid tapping mode is not used. (G84 cannot be used as a G code for the tapping cycle; G74 cannot be used for the reverse tapping cycle.)

**#4 DOV** Override during extraction in rigid tapping:

0: Invalidated

1: Validated (The override value is set in parameter No. 5211. However, set an override value for rigid tapping return in parameter No. 5381.)

**#5 PCP** Address Q is specified in a tapping cycle/Rigid tapping:

0: A high-speed peck tapping cycle is assumed.

1: A peck tapping cycle is assumed.

#### NOTE

In a tapping cycle, this parameter is valid when bit 6 (PCT) of parameter No. 5104 is 1. When bit 6 (PCT) of parameter No. 5104 is 0, a (high-speed) peck tapping cycle is not assumed.

**#6 FHD** Feed hold and single block in rigid tapping:

0: Invalidated

1: Validated

|      | #7 | #6 | #5 | #4  | #3  | #2 | #1 | #0 |
|------|----|----|----|-----|-----|----|----|----|
| 5201 |    |    |    | OV3 | OVU |    |    |    |

[Input type] Parameter input

[Data type] Bit path

**#3 OVU** The increment unit of the override parameter No. 5211 for tool rigid tapping extraction is:

0: 1%

1: 10%

**#4 OV3** A spindle speed for extraction is programmed, so override for extraction operation is:

0: Disabled.

1: Enabled.

|      | #7 | #6 | #5 | #4  | #3 | #2 | #1 | #0 |
|------|----|----|----|-----|----|----|----|----|
| 5203 |    |    |    | OVS |    |    |    |    |

[Input type] Parameter input

[Data type] Bit path

**#4 OVS** In rigid tapping, override by the feedrate override select signal and cancellation of override by the override cancel signal is:  
 0: Disabled.  
 1: Enabled.  
 When feedrate override is enabled, extraction override is disabled.  
 The spindle override is clamped to 100% during rigid tapping, regardless of the setting of this parameter.

|      |    |    |    |    |    |     |    |     |
|------|----|----|----|----|----|-----|----|-----|
|      | #7 | #6 | #5 | #4 | #3 | #2  | #1 | #0  |
| 5209 |    |    |    |    |    | DWP |    | RTX |

[Input type] Parameter input  
 [Data type] Bit path

**#0 RTX** In rigid tapping in a lathe system, the tapping axis is:  
 0: Selected by selecting a plane.  
 1: Always assumed to be the Z-axis for G84 or the X-axis for G88.

**NOTE**  
 This parameter becomes invalid when bit 1 (FCV) of parameter No.0001 is set to 1, and rigid tapping is specified using the Series 10/11 program format.

**#2 DWP** When a dwell (address P) command is not included in a block for lathe-system rigid tapping:  
 0: Dwelling at the bottom of a hole is not performed.  
 1: The dwell (address P) command specified in the block for drilling is valid.

**NOTE**  
 This parameter becomes invalid if rigid tapping is specified in the Series 10/11 program format with bit 1 (FCV) of parameter No. 0001 set to 1.

|      |  |
|------|--|
| 5211 | Override value during rigid tapping extraction |
|------|--|

[Input type] Parameter input  
 [Data type] Word path  
 [Unit of data] 1% or 10%  
 [Valid data range] 0 to 200  
 The parameter sets the override value during rigid tapping extraction.

**NOTE**  
 The override value is valid when bit 4 (DOV) of parameter No. 5200 is set to 1. When bit 3 (OVU) of parameter No. 5201 is set to 1, the unit of set data is 10%. An override of up to 2000% can be applied to extraction.

|      |                                    |
|------|------------------------------------|
| 5213 | Return in peck rigid tapping cycle |
|------|------------------------------------|

[Input type] Setting input  
 [Data type] Real path  
 [Unit of data] mm, inch (input unit)

[Min. unit of data] Depend on the increment system of the drilling axis  
 [Valid data range] 0 or positive 9 digit of minimum unit of data (refer to the standard parameter setting table (B))  
 (When the increment system is IS-B, 0.0 to +999999.999)  
 This parameter sets the escape value of a high-speed peck tapping cycle or the clearance value of a peck tapping cycle.

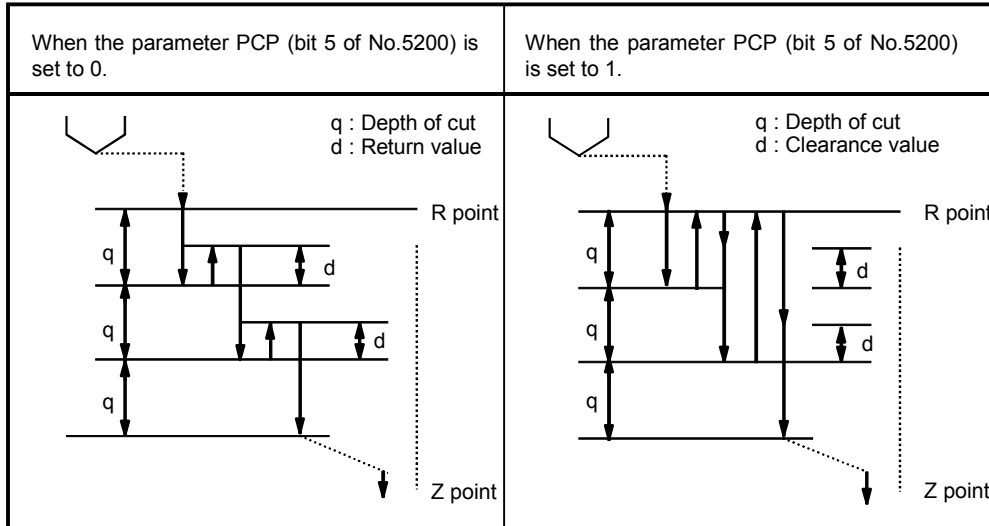

**NOTE**

- 1 In a tapping cycle, this parameter is valid when bit 6 (PCT) of parameter No. 5104 is 1.
- 2 For the diameter axis, set this parameter using the diameter value.

|             |   |
|-------------|---|
| <b>5241</b> | <b>Maximum spindle speed in rigid tapping (first gear)</b>  |
| <b>5242</b> | <b>Maximum spindle speed in rigid tapping (second gear)</b> |
| <b>5243</b> | <b>Maximum spindle speed in rigid tapping (third gear)</b>  |
| <b>5244</b> | <b>Maximum spindle speed in rigid tapping (fourth gear)</b> |

[Input type] Parameter input  
 [Data type] 2-word spindle  
 [Unit of data] min<sup>-1</sup>  
 [Valid data range] 0 to 9999  
 Spindle position coder gear ratio  
 1 : 1 0 to 7400  
 1 : 2 0 to 9999  
 1 : 4 0 to 9999  
 1 : 8 0 to 9999  
 Each of these parameters is used to set a maximum spindle speed for each gear in rigid tapping.  
 Set the same value for both parameter No. 5241 and parameter No. 5243 for a one-stage gear system. For a two-stage gear system, set the same value as set in parameter No. 5242 in parameter No. 5243. Otherwise, alarm PS0200, "ILLEGAL S CODE COMMAND" will be issued.

|             |  |
|-------------|--|
| <b>5321</b> | <b>Spindle backlash in rigid tapping (first-stage gear)</b>  |
| <b>5322</b> | <b>Spindle backlash in rigid tapping (second-stage gear)</b> |

|      |   |
|------|---|
| 5323 | Spindle backlash in rigid tapping (third-stage gear)  |
| 5324 | Spindle backlash in rigid tapping (fourth-stage gear) |

[Input type] Parameter input  
 [Data type] Word spindle  
 [Unit of data] Detection unit  
 [Valid data range] -9999 to 9999  
 Each of these parameters is used to set a spindle backlash.

|      |    |    |    |    |    |    |    |     |
|------|----|----|----|----|----|----|----|-----|
|      | #7 | #6 | #5 | #4 | #3 | #2 | #1 | #0  |
| 5400 |    |    |    |    |    |    |    | RIN |

[Input type] Parameter input  
 [Data type] Bit path

**#0 RIN** Coordinate rotation angle command (R) :  
 0: Specified by an absolute method  
 1: Specified by an absolute method (G90) or incremental method (G91)

|      |  |
|------|--|
| 5410 | Angular displacement used when no angular displacement is specified for coordinate system rotation |
|------|--|

[Input type] Setting input  
 [Data type] 2-word path  
 [Unit of data] 0.001 degree  
 [Valid data range] -360000 to 360000  
 This parameter sets the angular displacement for coordinate system rotation. When the angular displacement for coordinate system rotation is not specified with address R in the block where G68 is specified, the setting of this parameter is used as the angular displacement for coordinate system rotation.

|      |    |    |    |    |    |    |    |     |
|------|----|----|----|----|----|----|----|-----|
|      | #7 | #6 | #5 | #4 | #3 | #2 | #1 | #0  |
| 5431 |    |    |    |    |    |    |    | MDL |

[Input type] Parameter input  
 [Data type] Bit path

**#0 MDL** The G60 code (single direction positioning) is:  
 0: One-shot G code (group 00).  
 1: Modal G code (group 01).

|      |    |    |    |    |    |     |    |    |
|------|----|----|----|----|----|-----|----|----|
|      | #7 | #6 | #5 | #4 | #3 | #2  | #1 | #0 |
| 5450 |    |    |    |    |    | PLS |    |    |

[Input type] Parameter input  
 [Data type] Bit path

**#2 PLS** The polar coordinate interpolation shift function is:  
 0: Not used.  
 1: Used.  
 This enables machining using the workpiece coordinate system with a desired point which is not the center of the rotation axis set as the origin of the coordinate system in polar coordinate interpolation.

|             |  |
|-------------|--|
| <b>5460</b> | <b>Axis (linear axis) specification for polar coordinate interpolation</b> |
|-------------|--|

[Input type] Parameter input  
 [Data type] Byte path  
 [Valid data range] 1 to number of controlled axes  
 This parameter sets control axis numbers of linear axis to execute polar interpolation.

|             |  |
|-------------|--|
| <b>5461</b> | <b>Axis (rotation axis) specification for polar coordinate interpolation</b> |
|-------------|--|

[Input type] Parameter input  
 [Data type] Byte path  
 [Valid data range] 1 to number of controlled axes  
 This parameter sets control axis numbers of rotation axis to execute polar interpolation.

|             |  |
|-------------|--|
| <b>5463</b> | <b>Automatic override tolerance ratio for polar coordinate interpolation</b> |
|-------------|--|

[Input type] Parameter input  
 [Data type] Byte path  
 [Unit of data] %  
 [Valid data range] 0 to 100  
 Typical setting: 90% (treated as 90% when set to 0)  
 Set the tolerance ratio of the fastest cutting feedrate to the speed of the rotation axis during automatic override of polar coordinate interpolation.

|             |  |
|-------------|--|
| <b>5464</b> | <b>Compensation for error on hypothetical axis of polar coordinate interpolation</b> |
|-------------|--|

[Input type] Parameter input  
 [Data type] Byte path  
 [Unit of data] mm, inch (input unit)  
 [Min. unit of data] Depend on the increment system of the reference axis  
 [Valid data range] 9 digit of minimum unit of data (refer to standard parameter setting table (A))  
 (For IS-B, -999999.999 to +999999.999)  
 This parameter is used to set the error if the center of the rotation axis on which polar coordinate interpolation is performed is not on the X-axis.  
 If the setting of the parameter is 0, regular polar coordinate interpolation is performed.

|             |           |           |           |            |           |           |            |           |
|-------------|-----------|-----------|-----------|------------|-----------|-----------|------------|-----------|
|             | <b>#7</b> | <b>#6</b> | <b>#5</b> | <b>#4</b>  | <b>#3</b> | <b>#2</b> | <b>#1</b>  | <b>#0</b> |
| <b>6000</b> |           |           |           | <b>HGO</b> |           |           | <b>MGO</b> |           |

[Input type] Parameter input  
 [Data type] Bit path

**#1 MGO** When a GOTO statement for specifying custom macro control is executed, a high-speed branch to 20 sequence numbers executed from the start of the program is:  
 0: A high-speed branch is not caused to n sequence numbers from the start of the executed program.  
 1: A high-speed branch is caused to n sequence numbers from the start of the program.

**#4 HGO** When a GOTO statement for specifying custom macro control is executed, a branch to 30 sequence numbers just before the GOTO statement or to up to 10 sequence numbers saved by a sequence number search previously made with a GOTO statement is:  
 0: Not made at high speed.  
 1: Made at high speed.

|      | #7  | #6 | #5 | #4 | #3 | #2 | #1 | #0 |
|------|-----|----|----|----|----|----|----|----|
| 6240 | IGA |    |    |    |    |    |    |    |

[Input type] Parameter input  
 [Data type] Bit path

#7 **IGA** Automatic tool length measurement (M series) or automatic tool compensation (T series) is:  
 0: Used.  
 1: Not used.

|      |  |
|------|--|
| 6241 | Feedrate during measurement of automatic tool compensation (for the XAE1 and GAE1 signals) |
|------|--|

|      |  |
|------|--|
| 6242 | Feedrate during measurement of automatic tool compensation (for the XAE2 and GAE2 signals) |
|------|--|

[Input type] Parameter input  
 [Data type] Real path  
 [Unit of data] mm/min, inch/min, deg/min (machine unit)  
 [Min. unit of data] Depend on the increment system of the applied axis  
 [Valid data range] Refer to the standard parameter setting table (C)  
 (When the increment system is IS-B, 0.0 to +999000.0)  
 These parameters set the relevant feedrate during measurement of automatic tool compensation.

**NOTE**  
 When the setting of parameter No. 6242 or 6243 is 0, the setting of parameter No. 6241 is used.

|      |   |
|------|---|
| 6251 | $\gamma$ value on the X axis during automatic tool compensation |
|------|---|

|      |   |
|------|---|
| 6252 | $\gamma$ value on the Z axis during automatic tool compensation |
|------|---|

[Input type] Parameter input  
 [Data type] 2-word path  
 [Unit of data] mm, inch, deg (machine unit)  
 [Min. unit of data] Depend on the increment system of the applied axis  
 [Valid data range] 9 digit of minimum unit of data (refer to standard parameter setting table (A))  
 (When the increment system is IS-B, -999999.999 to +999999.999)  
 These parameters set the relevant  $\gamma$  value during automatic tool compensation.

**NOTE**  
 When the Reference axis (parameter No.1031) is Diameter specification, specify the diameter value. When the Reference axis (parameter No.1031) is Radius specification, specify the radius value.

|      |   |
|------|---|
| 6254 | $\epsilon$ value on the X axis during automatic tool compensation |
|------|---|

|      |   |
|------|---|
| 6255 | $\epsilon$ value on the Z axis during automatic tool compensation |
|------|---|

[Input type] Parameter input  
 [Data type] 2-word path  
 [Unit of data] mm, inch, deg (machine unit)



[Min. unit of data] Depend on the increment system of the applied axis  
 [Valid data range] 9 digit of minimum unit of data (refer to standard parameter setting table (A))  
 (When the increment system is IS-B, -999999.999 to +999999.999)  
 These parameters set the relevant ε value during automatic tool compensation.

**NOTE**  
 When the Reference axis (parameter No.1031) is Diameter specification, specify the diameter value. When the Reference axis (parameter No.1031) is Radius specification, specify the radius value.

|             |     |    |    |    |    |    |    |    |
|-------------|-----|----|----|----|----|----|----|----|
|             | #7  | #6 | #5 | #4 | #3 | #2 | #1 | #0 |
| <b>7600</b> | PLZ |    |    |    |    |    |    |    |

[Input type] Parameter input  
 [Data type] Bit path

**#7 PLZ** Reference position return based on a G28 command on the tool rotation axis for polygon turning is:  
 0: Performed in the same sequence as manual reference position return.  
 1: Performed by positioning using the rapid traverse rate.  
 The synchronous axis returns to the reference position in the same sequence as the manual reference position return when no return-to-reference position is performed after the power is turned on.

|             |     |    |    |    |    |    |    |    |
|-------------|-----|----|----|----|----|----|----|----|
|             | #7  | #6 | #5 | #4 | #3 | #2 | #1 | #0 |
| <b>7604</b> | PCG |    |    |    |    |    |    |    |

[Input type] Parameter input  
 [Data type] Bit path

**NOTE**  
 When this parameter is set, the power must be turned off before operation is continued.

**#7 PCG** If both the spindle-spindle polygon turning and the polygon turning are specified:  
 0: Spindle-spindle polygon turning is performed.  
 1: Either of the functions is enabled depending on the setting of parameter No. 7605.

**NOTE**  
 The spindle-spindle polygon turning is enabled, when bit 6 (SPG) of parameter No. 8133 is 1).

|             |                                       |
|-------------|---------------------------------------|
| <b>7605</b> | <b>Polygon turning type selection</b> |
|-------------|---------------------------------------|

[Input type] Parameter input  
 [Data type] Byte path  
 [Valid data range] 0, 1  
 If both the spindle-spindle polygon turning and the polygon turning are specified, this parameter can be used to select one of the functions for use. A type of polygon turning is selected according to the setting as follows:  
 0: Polygon machining with two spindles  
 1: Polygon turning

If a value other than 0 or 1 is specified, 0 is assumed.

**NOTE**

- 1 The spindle-spindle polygon turning is enabled, when bit 6 (SPG) of parameter No. 8133 is 1).
- 2 Before re-setting this parameter, using the PMC window function or the G10 command, cancel polygon turning (G50.2). In addition, when re-setting this parameter, using the PMC window function, use the M code not involving buffering.

7610

Control axis number of tool rotation axis for polygon turning

**NOTE**

When this parameter is set, the power must be turned off before operation is continued.

[Input type] Parameter input

[Data type] Byte path

[Valid data range] 1 to number of controlled axes

This parameter sets the control axis number of a rotation tool axis used for polygon turning.

However, when a G51.2 command is executed by setting 0 in this parameter, operation stops with the alarm PS0314, "ILLEGAL SETTING OF POLYGONAL AXIS".

7640

Master axis in spindle-spindle polygon turning

[Input type] Parameter input

[Data type] Byte path

[Valid data range] 0 to Maximum number of controlled axes (Within a path)

This parameter sets the master axis in spindle-spindle polygon turning.

**NOTE**

- 1 Spindle-spindle polygon turning is enabled only for serial spindles.
- 2 When any one of parameters Nos. 7640 and 7641 is set to 0, polygon turning is performed using the first spindle (master axis) and the second spindle (polygon synchronous axis) in the path to which the parameter belongs.
- 3 When a spindle other than the first serial spindle is used as a master axis, the multi-spindle control is required to specify an S command for the master axis.
- 4 When the PMC window function or G10 command is used to rewrite this parameter, rewrite this parameter before the block specifying the spindle-spindle polygon command G51.2. When the PMC window function is used to rewrite this parameter in the block immediately before G51.2, specify the rewriting of this parameter by using an M code (parameter No. 3411 and up) without buffering.

**7641****Polygon synchronous axis in spindle-spindle polygon turning**

[Input type] Parameter input

[Data type] Byte path

[Valid data range] 0 to Maximum number of controlled axes (Within a path)

This parameter sets the polygon synchronous (slave) axis in spindle-spindle polygon turning.

**NOTE**

- 1 Spindle-spindle polygon turning is enabled only for serial spindles.
- 2 When any one of parameter Nos. 7640 and 7641 is set to 0, polygon turning is performed using the first spindle (master axis) and the second spindle (polygon synchronous axis) in the path to which the parameter belongs.
- 3 When a spindle other than the first serial spindle is used as a master axis, the multi-spindle control is required to specify an S command for the master axis.
- 4 When the PMC window function or G10 command is used to rewrite this parameter, rewrite this parameter before the block specifying the spindle-spindle polygon command G51.2. When the PMC window function is used to rewrite this parameter in the block immediately before G51.2, specify the rewriting of this parameter by using an M code (parameter No. 3411 and up) without buffering.

**7642****Master axis in spindle-spindle polygon turning (spindle number common to the system)**

[Input type] Parameter input

[Data type] Byte path

[Valid data range] 0 to Maximum number of controlled axes (Common to the system)

This parameter sets the master axis in spindle-spindle polygon turning.

**NOTE**

- 1 Spindle-spindle polygon turning is enabled only for serial spindles.
- 2 This parameter is invalid if either parameter No. 7642 or No.7643 is set to 0. In this case, the settings of parameter Nos. 7640 and 7641 are valid.
- 3 When a spindle other than the first serial spindle is used as a master axis, the multi-spindle control is required to specify an S command for the master axis.
- 4 When the PMC window function or G10 command is used to rewrite this parameter, rewrite this parameter before the block specifying the spindle-spindle polygon command G51.2. When the PMC window function is used to rewrite this parameter in the block immediately before G51.2, specify the rewriting of this parameter by using an M code (parameter No. 3411 and up) without buffering.
- 5 A spindle number common to the system is to be set in this parameter. When using this parameter, set 0 in parameter Nos. 7640 and 7641.

|             |  |
|-------------|--|
| <b>7643</b> | <b>Polygon synchronous axis in spindle-spindle polygon turning (spindle number common to the system)</b> |
|-------------|--|

[Input type] Parameter input  
 [Data type] Byte path  
 [Valid data range] 0 to Maximum number of controlled axes (Common to the system)  
 This parameter sets the polygon synchronous (slave) axis in spindle-spindle polygon turning.

**NOTE**

- 1 Spindle-spindle polygon turning is enabled only for serial spindles.
- 2 This parameter is invalid if either parameter No. 7642 or No.7643 is set to 0. In this case, the settings of parameter Nos. 7640 and 7641 are valid.
- 3 When a spindle other than the first serial spindle is used as a master axis, the multi-spindle control is required to specify an S command for the master axis.
- 4 When the PMC window function or G10 command is used to rewrite this parameter, rewrite this parameter before the block specifying the spindle-spindle polygon command G51.2. When the PMC window function is used to rewrite this parameter in the block immediately before G51.2, specify the rewriting of this parameter by using an M code (parameter No. 3411 and up) without buffering.
- 5 A spindle number common to the system is to be set in this parameter. When using this parameter, set 0 in parameter Nos. 7640 and 7641.

|             |    |    |    |    |    |    |            |    |
|-------------|----|----|----|----|----|----|------------|----|
|             | #7 | #6 | #5 | #4 | #3 | #2 | #1         | #0 |
| <b>8103</b> |    |    |    |    |    |    | <b>MWP</b> |    |

[Input type] Parameter input  
 [Data type] Bit

**NOTE**  
 When at least one of these parameters is set, the power must be turned off before operation is continued.

**#1 MWP** To specify a P command for the waiting M code/balance cut:  
 0: A binary value is used as conventionally done.  
 1: A path number combination is used.

|             |    |    |    |    |    |    |            |    |
|-------------|----|----|----|----|----|----|------------|----|
|             | #7 | #6 | #5 | #4 | #3 | #2 | #1         | #0 |
| <b>8132</b> |    |    |    |    |    |    | <b>YOF</b> |    |

**NOTE**  
 When at least one of these parameters is set, the power must be turned off before operation is continued.

[Input type] Parameter input  
 [Data type] Bit

- #1 YOF** Y-axis offset is:  
 0: Not Used.  
 1: Used.

|      | #7 | #6  | #5 | #4 | #3 | #2  | #1  | #0 |
|------|----|-----|----|----|----|-----|-----|----|
| 8133 |    | SPG |    |    |    | SCS | AXC |    |
|      |    |     |    |    |    | SCS |     |    |

**NOTE**

When at least one of these parameters is set, the power must be turned off before operation is continued.

[Input type] Parameter input

[Data type] Bit

- #1 AXC** Spindle positioning is:  
 0: Not Used.  
 1: Used.

**NOTE**

- 1 Be sure to set 1 in bit 1 (AXC) of parameter No.8133 and 0 in bit 2 (SCS) of parameter No.8133 to use the spindle positioning function.
- 2 Both serial spindle Cs contour control function and spindle positioning function cannot be made effective at the same time. If both are specified as AXC=1 and SCS=1, both functions become invalid. Therefore, when a negative value is set in parameter No.1023 with above specification, alarm (SV1026) is generated.
- 3 Be sure to set 0 in bit 1 (AXC) of parameter No.8133 and 1 in bit 2 (SCS) of parameter No.8133 to use the serial spindle Cs contour control function.

- #2 SCS** Cs contour control is:  
 0: Not Used.  
 1: Used.

**NOTE**

- 1 Be sure to set 0 in bit 1 (AXC) of parameter No.8133 and 1 in bit 2 (SCS) of parameter No.8133 to use the serial spindle Cs contour control function.
- 2 Both serial spindle Cs contour control function and spindle positioning function cannot be made effective at the same time. If both are specified as AXC=1 and SCS=1, both functions become invalid. Therefore, when a negative value is set in parameter No.1023 with above specification, alarm (SV1026) is generated.
- 3 Be sure to set 1 in bit 1 (AXC) of parameter No.8133 and 0 in bit 2 (SCS) of parameter No.8133 to use the spindle positioning function.

**#6 SPG** Polygon turning with two spindles is:  
 0: Not Used.  
 1: Used.

**NOTE**  
 Be sure to invalidate the polygon turning with two spindles by this parameter when polygon turning is used. If the polygon turning is performed when 1 is set in this parameter, the alarm is issued.

|      |    |    |    |    |    |     |     |    |
|------|----|----|----|----|----|-----|-----|----|
|      | #7 | #6 | #5 | #4 | #3 | #2  | #1  | #0 |
| 8134 |    |    |    |    |    | CCR | BAR |    |
|      |    |    |    |    |    |     | BAR |    |

**NOTE**  
 When at least one of these parameters is set, the power must be turned off before operation is continued.

[Input type] Parameter input  
 [Data type] Bit

**#1 BAR** Chuck and tail stock barrier function (T series) is:  
 0: Not Used.  
 1: Used.

**NOTE**  
 1 The chuck and tail stock barrier function is provided only for the T series.  
 2 When the chuck and tail stock barrier function is selected, stored stroke limits 2 and 3 cannot be used.

That is, this parameter also specifies whether to use stored stroke limits 2 and 3 as shown below.

**BAR** Stored stroke limits 2 and 3 are:  
 0: Used.  
 1: Not Used.

**#2 CCR** Chamfering / corner R is:  
 0: Not Used.  
 1: Used.

|      |     |     |    |    |    |    |    |    |
|------|-----|-----|----|----|----|----|----|----|
|      | #7  | #6  | #5 | #4 | #3 | #2 | #1 | #0 |
| 8136 | NCR | NGW |    |    |    |    |    |    |
|      |     | NGW |    |    |    |    |    |    |

**NOTE**  
 When at least one of these parameters is set, the power must be turned off before operation is continued.

[Input type] Parameter input  
 [Data type] Bit

**#6 NGW** Tool offset memory C (M series) or tool geometry/wear compensation (T series) is:  
 0: Used.  
 1: Not Used.

**#7 NCR** Tool nose radius compensation is:  
 0: Used.  
 1: Not Used.

|             |           |           |            |           |            |            |            |            |
|-------------|-----------|-----------|------------|-----------|------------|------------|------------|------------|
| <b>8137</b> | <b>#7</b> | <b>#6</b> | <b>#5</b>  | <b>#4</b> | <b>#3</b>  | <b>#2</b>  | <b>#1</b>  | <b>#0</b>  |
|             |           |           | <b>NPI</b> |           | <b>NMR</b> | <b>NDD</b> | <b>NVL</b> | <b>NCV</b> |

**NOTE**  
 When this parameter is set, the power must be turned off before operation is continued.

[Input type] Parameter input  
 [Data type] Bit

**#0 NVC** Balance cutting is:  
 0: Used.  
 1: Not Used.

**NOTE**  
 When balance cutting is used (this parameter is 0), the mirror image for double turret cannot be used. To use the mirror image for double turret, set this parameter to 1.

**#1 NVL** Variable lead thread cutting is:  
 0: Used.  
 1: Not Used.

**#2 NDD** Direct drawing dimension programming is:  
 0: Used.  
 1: Not Used.

**#3 NMR** Multiple repetitive cycle is:  
 0: Used.  
 1: Not Used.

**#5 NPI** Polar coordinate interpolation is:  
 0: Used.  
 1: Not Used.

|             |           |           |           |           |           |             |           |           |
|-------------|-----------|-----------|-----------|-----------|-----------|-------------|-----------|-----------|
| <b>8162</b> | <b>#7</b> | <b>#6</b> | <b>#5</b> | <b>#4</b> | <b>#3</b> | <b>#2</b>   | <b>#1</b> | <b>#0</b> |
|             |           |           |           |           |           | <b>PKUx</b> |           |           |

[Input type] Parameter input  
 [Data type] Bit axis

**#2 PKUx** In the parking state,  
 0: The absolute, relative, and machine coordinates are not updated.  
 1: The absolute and relative coordinates are updated. The machine coordinates are not updated.

**NOTE**

- 1 With an axis for which polar coordinate interpolation is specified, set this parameter to 1. If this parameter is set to 0, a coordinate shift can occur when a single block stop or feed hold is performed in the polar coordinate interpolation mode.
- 2 With an axis that is set to function as a synchronous master axis and synchronous slave axis at the same time (with bit 1 (SYWx) of parameter No. 8167), set this parameter to 1.
- 3 With an axis specified in the 3-dimensional coordinate conversion mode, set this parameter to 1. If this parameter is set to 0, the alarm PS0367, "3-D CONV. WAS COMMANDED IN SYNC MODE AS THE PARAMETER PKUx(NO.8162#2) IS 0." is issued.

|             |             |           |           |           |           |           |           |           |
|-------------|-------------|-----------|-----------|-----------|-----------|-----------|-----------|-----------|
|             | <b>#7</b>   | <b>#6</b> | <b>#5</b> | <b>#4</b> | <b>#3</b> | <b>#2</b> | <b>#1</b> | <b>#0</b> |
| <b>8163</b> | <b>NUMx</b> |           |           |           |           |           |           |           |

[Input type] Parameter input  
 [Data type] Bit axis

**#7 NUMx** When neither synchronous control nor composite control is applied, a move command for the axis is:  
 0: Not disabled.  
 1: Disabled.

**NOTE**

If a move command is specified for an axis with NUMx set to 1 when neither synchronous control nor composite control is applied, alarm PS0353, "THE INSTRUCTION WAS DONE FOR THE AXIS WHICH WAS NOT ABLE TO MOVE." is issued.

|             |           |             |             |             |             |             |             |           |
|-------------|-----------|-------------|-------------|-------------|-------------|-------------|-------------|-----------|
|             | <b>#7</b> | <b>#6</b>   | <b>#5</b>   | <b>#4</b>   | <b>#3</b>   | <b>#2</b>   | <b>#1</b>   | <b>#0</b> |
| <b>8167</b> |           | <b>SPVx</b> | <b>SWSx</b> | <b>SWMx</b> | <b>SGSx</b> | <b>SGMx</b> | <b>SYWx</b> |           |

[Input type] Parameter input  
 [Data type] Bit axis

**#1 SYWx** The axis is:  
 0: Not used as a master axis and slave axis at the same time.  
 1: Used as a master axis and slave axis at the same time.

**#2 SGMx** In automatic workpiece coordinate system setting at the start of synchronous control, a tool offset is:  
 0: Considered.  
 1: Not considered.

**NOTE**

SGMx is enabled when bit 1 (SPMx) of parameter No. 8163 is set to 1.



- #3 SGSx** In automatic workpiece coordinate system setting at the end of synchronous control, a tool offset is:  
 0: Considered.  
 1: Not considered.

**NOTE**

SGSx is enabled when bit 2 (SPSx) of parameter No. 8163 or bit 6 (SPVx) of parameter No. 8167 is set to 1.

- #4 SWMx** In automatic workpiece coordinate system setting at the start of synchronous control, a workpiece shift is:  
 0: Not considered.  
 1: Considered.

**NOTE**

SWMx is enabled when bit 1 (SPMx) of parameter No. 8163 is set to 1.

- #5 SWSx** In automatic workpiece coordinate system setting at the end of synchronous control, a workpiece shift is:  
 0: Not considered.  
 1: Considered.

**NOTE**

SWSx is enabled when bit 2 (SPSx) of parameter No. 8163 or bit 6 (SPVx) of parameter No. 8167 is set to 1.

- #6 SPVx** At the end of synchronous control, automatic workpiece coordinate system setting for the slave axis is:  
 0: Not performed.  
 1: Performed.

**NOTE**

When a workpiece coordinate system is automatically set at the end of synchronous control, the workpiece coordinate system is calculated from the current machine coordinates and the workpiece coordinates for each axis at the reference position set in parameter No. 1250.

|             |           |             |           |           |           |           |           |           |
|-------------|-----------|-------------|-----------|-----------|-----------|-----------|-----------|-----------|
|             | <b>#7</b> | <b>#6</b>   | <b>#5</b> | <b>#4</b> | <b>#3</b> | <b>#2</b> | <b>#1</b> | <b>#0</b> |
| <b>8169</b> |           | <b>SESx</b> |           |           |           |           |           |           |

[Input type] Parameter input

[Data type] Bit axis

- #6 SESx** If a synchronization error is out of the tolerable range (specified with parameter No. 8181):  
 0: Alarm SV0407, "EXCESS ERROR", is issued.  
 1: No alarm is issued. Instead, the excess synchronization error signal SEO<Fn559> is output.

SESx is valid when bit 1 (SERx) of parameter No. 8162 is 1. Specify the value of this parameter for the slave axis.

8180

Master axis with which an axis is synchronized under synchronous control

[Input type] Parameter input

[Data type] Word axis

[Valid data range] 101, 102, 103, . . . , (path number)\*100+(intra-path relative axis number) (101, 102, 103, . . . , 201, 202, 203, . . . )

This parameter sets the path number and intra-path relative axis number of the master axis with which each axis is synchronized. When zero is specified, the axis does not become a slave axis and is not synchronized with another axis. When an identical number is specified in two or more parameters, one master axis has two or more slave axes.

8183

Composite control axis of the other path in composite control for each axis

[Input type] Parameter input

[Data type] Word axis

[Valid data range] 101, 102, 103, . . . , (path number)\*100+(intra-path relative axis number) (101, 102, 103, . . . , 201, 202, 203, . . . )

This parameter sets with which axis each axis is to be placed under composite control. When zero is specified, control of the axis is not replaced under composite control. An identical number can be specified in two or more parameters, but composite control cannot be exercised for all of them at a time.

**NOTE**

When the two-path interface is used (bit 1 (MIX) of parameter No. 8166 is set to 1), set this parameter for path 2.

8186

Master axis under superimposed control

[Input type] Parameter input

[Data type] Word axis

[Valid data range] 101, 102, 103, . . . , (path number)\*100+(intra-path relative axis number) (101, 102, 103, . . . , 201, 202, 203, . . . )

This parameter sets the path number and intra-path relative axis number of a superimposed master axis for each axis when superimposed control is exercised. When zero is specified, the axis does not become a slave axis under superimposed control and the move pulse of another axis is not superimposed.

An identical number can be specified in two or more parameters to exercise superimposed control simultaneously. This means that superimposed control with one master axis and multiple slave axes is possible.

A slave axis may function as the master axis of another axis to allow three-generation superimposed control: parent (master axis) - child (slave axis/master axis) - grandchild (slave axis).

In this case, a movement along the child is made by its travel distance plus the travel distance of the parent, and a movement along the grandchild is made by its travel distance plus the travel distance of the child plus the travel distance of the parent.

Example of the relationship of parent (X1 of path 1) - child (X2 of path 2) - grandchild (U2 of path 2):

The travel distance of X1 is superimposed on X2, and the travel distances of X1 and X2 are further superimposed on U2.

Parameter No. 8186x of path 2 = 101  
 Parameter No. 8186u of path 2 = 201

|              | #7 | #6 | #5 | #4 | #3 | #2 | #1         | #0 |
|--------------|----|----|----|----|----|----|------------|----|
| <b>11400</b> |    |    |    |    |    |    | <b>NO5</b> |    |

[Input type] Parameter input  
 [Data type] Bit path

**#1 NO5** The fifth axis offset function is:  
 0: Not used.  
 1: Used.

|              | #7         | #6 | #5 | #4 | #3 | #2 | #1 | #0 |
|--------------|------------|----|----|----|----|----|----|----|
| <b>11507</b> | <b>SAC</b> |    |    |    |    |    |    |    |

[Input type] Parameter input  
 [Data type] Bit

**#7 SAC** When the spindle speed arrival SAR<Gn029.4> is checked in canned cycle for drilling,  
 0: It is waiting for elapsing time that is set parameter No.3740 at the starting of all drilling.  
 1: It is waiting for elapsing time that is set parameter No.3740 at the starting of only first drilling. It is available block overlap between rapid traverse to the initial lever and rapid traverse of positioning to a position of hole.

**NOTE**

- When this parameter is set, the power must be turned off before operation is continued.
- This parameter is available when bit 0 (SAR) of parameter No.3708 is set 1.
- Block overlap in rapid traverse is available when bit 4 (RTO) of parameter No.1601 is set 1.

|              | #7 | #6 | #5 | #4 | #3 | #2 | #1 | #0         |
|--------------|----|----|----|----|----|----|----|------------|
| <b>11630</b> |    |    |    |    |    |    |    | <b>FRD</b> |

[Input type] Parameter input  
 [Data type] Bit path

**#0 FRD** The minimum command unit of the rotation angles of coordinate rotation and 3-dimensional coordinate system conversion is:  
 0: 0.001 degree.  
 1: 0.00001 degree. (1/100,000)

|              |  |  |  |  |  |  |  |  |
|--------------|--|--|--|--|--|--|--|--|
| <b>12600</b> | <b>Identification Number for synchronous, composite, and superimposed control by program command</b> |  |  |  |  |  |  |  |
|--------------|--|--|--|--|--|--|--|--|

[Input type] Parameter input  
 [Data type] Word axis  
 [Valid data range] 0,1 to 32767  
 Set identification numbers that can be specified with P,Q addresses.  
 The axis whose identification number is 0 cannot become under synchronous, composite, and superimposed control by program command.  
 The same identification number cannot be set to two or more axes through all paths.

When the same identification number is set, alarm PS5339 occurs at G50.4/G50.5/G50.6/G51.4/G51.5/G51.6 block.

|              |  |
|--------------|--|
| <b>13543</b> | <b>M code for C-axis unclamping in canned cycles for drilling (1st pair)</b> |
|--------------|--|

[Input type] Parameter input  
 [Data type] 2-word path  
 [Valid data range] 0 to 99999999  
 This parameter sets the M code for C-axis unclamping in canned cycles for drilling (first pair).

**NOTE**  
 This parameter is valid when bit 4 (CME) of parameter No. 5161 is set to 1.

|              |  |
|--------------|--|
| <b>13544</b> | <b>M code for C-axis clamping in canned cycles for drilling (2nd pair)</b> |
|--------------|--|

[Input type] Parameter input  
 [Data type] 2-word path  
 [Valid data range] 0 to 99999999  
 This parameter sets the M code for C-axis clamping in canned cycles for drilling (second pair).

**NOTE**  
 This parameter is valid when bit 4 (CME) of parameter No. 5161 is set to 1.

|              |  |
|--------------|--|
| <b>13545</b> | <b>M code for C-axis unclamping in canned cycles for drilling (2nd pair)</b> |
|--------------|--|

[Input type] Parameter input  
 [Data type] 2-word path  
 [Valid data range] 0 to 99999999  
 This parameter sets the M code for C-axis unclamping in canned cycles for drilling (second pair).

**NOTE**  
 This parameter is valid when bit 4 (CME) of parameter No. 5161 is set to 1.

|              | #7 | #6  | #5  | #4 | #3 | #2  | #1 | #0 |
|--------------|----|-----|-----|----|----|-----|----|----|
| <b>19607</b> |    | NAA | CAV |    |    | CCC |    |    |

[Input type] Parameter input  
 [Data type] Bit path

**#2 CCC** In the cutter compensation/tool nose radius compensation mode, the outer corner connection method is based on:  
 0: Linear connection type.  
 1: Circular connection type.

- #5 CAV** When an interference check finds that interference (overcutting) occurred:
- 0: Machining stops with the alarm PS0041, “INTERFERENCE IN CUTTER COMPENSATION”.  
(Interference check alarm function)
  - 1: Machining is continued by changing the tool path to prevent interference (overcutting) from occurring. (Interference check avoidance function)
- For the interference check method, see the descriptions of bit 1 (CNC) of parameter No. 5008 and bit 3 (CNV) of parameter No. 5008.
- #6 NAA** When the interference check avoidance function considers that an avoidance operation is dangerous or that a further interference to the interference avoidance vector occurs:
- 0: An alarm is issued.  
When an avoidance operation is considered to be dangerous, the alarm PS5447, “DANGEROUS AVOIDANCE AT G41/G42” is issued.  
When a further interference to the interference avoidance vector is considered to occur, the alarm PS5448, “INTERFERENCE TO AVD. AT G41/G42” is issued.
  - 1: No alarm is issued, and the avoidance operation is continued.

**CAUTION**

When this parameter is set to 1, the path may be shifted largely. Therefore, set this parameter to 0 unless special reasons are present.

**19625****Number of blocks to be read in the cutter compensation/tool nose radius compensation mode**

[Input type] Setting input

[Data type] Byte path

[Valid data range] 3 to 8

This parameter sets the number of blocks to be read in the cutter compensation/tool nose radius compensation mode. When a value less than 3 is set, the specification of 3 is assumed. When a value greater than 8 is set, the specification of 8 is assumed. As a greater number of blocks are read, an overcutting (interference) forecast can be made with a command farther ahead. However, the number of blocks read and analyzed increases, so that a longer block processing time becomes necessary.

Even if the setting of this parameter is modified in the MDI mode by stopping in the cutter compensation/tool nose radius compensation mode, the setting does not become valid immediately. Before the new setting of this parameter can become valid, the cutter compensation/tool nose radius compensation mode must be canceled, then the mode must be entered again.

## A.2 DATA TYPE

Parameters are classified by data type as follows:

| Data type            | Valid data range                           | Remarks  |
|----------------------|--|--|
| Bit                  | 0 or 1                                     |  |
| Bit machine group    |  |  |
| Bit path             |  |  |
| Bit axis             |  |  |
| Bit spindle          |  |  |
| Byte                 | -128 to 127<br>0 to 255                    | Some parameters handle these types of data as unsigned data. |
| Byte machine group   |  |  |
| Byte path            |  |  |
| Byte axis            |  |  |
| Byte spindle         |  |  |
| Word                 | -32768 to 32767<br>0 to 65535              | Some parameters handle these types of data as unsigned data. |
| Word machine group   |  |  |
| Word path            |  |  |
| Word axis            |  |  |
| Word spindle         |  |  |
| 2-word               | 0 to ±999999999                            | Some parameters handle these types of data as unsigned data. |
| 2-word machine group |  |  |
| 2-word path          |  |  |
| 2-word axis          |  |  |
| 2-word spindle       |  |  |
| Real                 | See the Standard Parameter Setting Tables. |  |
| Real machine group   |  |  |
| Real path            |  |  |
| Real axis            |  |  |
| Real spindle         |  |  |

### NOTE

- 1 Each of the parameters of the bit, bit machine group, bit path, bit axis, and bit spindle types consists of 8 bits for one data number (parameters with eight different meanings).
- 2 For machine group types, parameters corresponding to the maximum number of machine groups are present, so that independent data can be set for each machine group.
- 3 For path types, parameters corresponding to the maximum number of paths are present, so that independent data can be set for each path.
- 4 For axis types, parameters corresponding to the maximum number of control axes are present, so that independent data can be set for each control axis.
- 5 For spindle types, parameters corresponding to the maximum number of spindles are present, so that independent data can be set for each spindle axis.
- 6 The valid data range for each data type indicates a general range. The range varies according to the parameters. For the valid data range of a specific parameter, see the explanation of the parameter.

## A.3 STANDARD PARAMETER SETTING TABLES

This section defines the standard minimum data units and valid data ranges of the CNC parameters of the real type, real machine group type, real path type, real axis type, and real spindle type. The data type and unit of data of each parameter conform to the specifications of each function.

### NOTE

- 1 Values are rounded up or down to the nearest multiples of the minimum data unit.
- 2 A valid data range means data input limits, and may differ from values representing actual performance.
- 3 For information on the ranges of commands to the CNC, refer to Appendix D, "Range of Command Value" in the OPERATOR'S MANUAL (Common to Lathe System / Machining Center System).

### (A) Length and angle parameters (type 1)

| Unit of data | Increment system | Minimum data unit | Valid data range |                |
|--------------|------------------|-------------------|------------------|----------------|
| mm<br>deg.   | IS-A             | 0.01              | -999999.99       | to +999999.99  |
|              | IS-B             | 0.001             | -999999.999      | to +999999.999 |
|              | IS-C             | 0.0001            | -99999.9999      | to +99999.9999 |
| inch         | IS-A             | 0.001             | -99999.999       | to +99999.999  |
|              | IS-B             | 0.0001            | -99999.9999      | to +99999.9999 |
|              | IS-C             | 0.00001           | -9999.99999      | to +9999.99999 |

### (B) Length and angle parameters (type 2)

| Unit of data | Increment system | Minimum data unit | Valid data range |                |
|--------------|------------------|-------------------|------------------|----------------|
| mm<br>deg.   | IS-A             | 0.01              | 0.00             | to +999999.99  |
|              | IS-B             | 0.001             | 0.000            | to +999999.999 |
|              | IS-C             | 0.0001            | 0.0000           | to +99999.9999 |
| inch         | IS-A             | 0.001             | 0.000            | to +99999.999  |
|              | IS-B             | 0.0001            | 0.0000           | to +99999.9999 |
|              | IS-C             | 0.00001           | 0.00000          | to +9999.99999 |

### (C) Velocity and angular velocity parameters

| Unit of data         | Increment system | Minimum data unit | Valid data range |                |
|----------------------|------------------|-------------------|------------------|----------------|
| mm/min<br>degree/min | IS-A             | 0.01              | 0.00             | to +999000.00  |
|                      | IS-B             | 0.001             | 0.000            | to +999000.000 |
|                      | IS-C             | 0.0001            | 0.0000           | to +99999.9999 |
| inch/min             | IS-A             | 0.001             | 0.000            | to +96000.000  |
|                      | IS-B             | 0.0001            | 0.0000           | to +9600.0000  |
|                      | IS-C             | 0.00001           | 0.00000          | to +4000.00000 |

### (D) Acceleration and angular acceleration parameters

| Unit of data                                 | Increment system | Minimum data unit | Valid data range |                |
|--|------------------|-------------------|------------------|----------------|
| mm/sec <sup>2</sup><br>deg./sec <sup>2</sup> | IS-A             | 0.01              | 0.00             | to +999999.99  |
|  | IS-B             | 0.001             | 0.000            | to +999999.999 |
|  | IS-C             | 0.0001            | 0.0000           | to +99999.9999 |
| inch/sec <sup>2</sup>                        | IS-A             | 0.001             | 0.000            | to +99999.999  |
|  | IS-B             | 0.0001            | 0.0000           | to +99999.9999 |
|  | IS-C             | 0.00001           | 0.00000          | to +9999.99999 |

# B LIST OF FUNCTIONS INCLUDE ADDRESS P IN THE PROGRAM COMMAND

## B.1 LIST OF FUNCTIONS INCLUDE ADDRESS P IN THE ARGUMENT OF G CODE

The function including address P in the argument of G code is shown below.

| Function name  | Machining center system | Lathe system  |       |       | Reference item  |
|--|-------------------------|---------------|-------|-------|---|
|  |                         | G code system |       |       |   |
|  |                         | A             | B     | C     |   |
| Dwell  | G04                     | G04           | G04   | G04   | OPERATOR'S MANUAL (Common to T/M Series) II. PROGRAMMING, "FEED FUNCTIONS"  |
| G code preventing buffering  | G04.1                   | G04.1         | G04.1 | G04.1 | - CONNECTION MANUAL (FUNCTION) "PROGRAM COMMAND"<br>- OPERATOR'S MANUAL (Common to T/M Series) II. PROGRAMMING, "HIGH-SPEED CUTTING FUNCTIONS"  |
| AI advanced preview control(M Series)/AI contour control (advanced preview control compatible command) | G08                     | G08           | G08   | G08   | - CONNECTION MANUAL (FUNCTION) "FEEDRATE CONTROL/ACCELERATION AND DECELERATION CONTROL"<br>- OPERATOR'S MANUAL (Common to T/M Series) II. PROGRAMMING, "HIGH-SPEED CUTTING FUNCTIONS" |
| Programmable data input  | G10                     | G10           | G10   | G10   | OPERATOR'S MANUAL (Common to T/M Series) II. PROGRAMMING, "PROGRAMMABLE DATA INPUT (G10)"   |
| Programmable parameter input   | G10                     | G10           | G10   | G10   | OPERATOR'S MANUAL (Common to T/M Series) II. PROGRAMMING, "PROGRAMMABLE DATA INPUT (G10)"   |
| Spindle speed fluctuation detection  | -                       | G26           | G26   | G26   | - CONNECTION MANUAL (FUNCTION) "SPINDLE SPEED FUNCTION"<br>- OPERATOR'S MANUAL (Common to T/M Series) II. PROGRAMMING, "SPINDLE SPEED FUNCTION"                                       |
| Reference position return  | G30                     | G30           | G30   | G30   | OPERATOR'S MANUAL (Common to T/M Series) II. PROGRAMMING, "REFERENCE POSITION"  |
| Multi-step skip  | G31                     | G31           | G31   | G31   | OPERATOR'S MANUAL (Common to T/M Series) II. PROGRAMMING, "INTERPOLATION FUNCTIONS"   |
| Torque limit skip  | G31                     | G31           | G31   | G31   | OPERATOR'S MANUAL (Common to T/M Series) II. PROGRAMMING, "INTERPOLATION FUNCTIONS"   |
| Continuous high-speed skip   | G31                     | G31           | G31   | G31   | OPERATOR'S MANUAL (Common to T/M Series) II. PROGRAMMING, "INTERPOLATION FUNCTIONS"   |
| Skip function for EGB axis   | G31.8                   | -             | -     | -     | CONNECTION MANUAL (FUNCTION) "AXIS CONTROL"   |



**B. LIST OF FUNCTIONS INCLUDE  
ADDRESS P IN THE PROGRAM  
COMMAND**

B-64604EN-1/01

**APPENDIX**

| Function name  | Machining center system             | Lathe system                        |                                     |                                     | Reference item  |
|--|-------------------------------------|-------------------------------------|-------------------------------------|-------------------------------------|---|
|  |                                     | G code system                       |                                     |                                     |   |
|  |                                     | A                                   | B                                   | C                                   |   |
| Scaling  | G51                                 | -                                   | -                                   | -                                   | - CONNECTION MANUAL (FUNCTION)<br>"PROGRAM COMMAND"<br>- OPERATOR'S MANUAL (For M Series)<br>II. PROGRAMMING, "COMPENSATION<br>FUNCTION"                  |
| Polygon turning  | -                                   | G51.2<br>(G251)                     | G51.2<br>(G251)                     | G51.2<br>(G251)                     | - CONNECTION MANUAL (FUNCTION)<br>"INTERPOLATION FUNCTION"<br>- OPERATOR'S MANUAL (For T Series)<br>II. PROGRAMMING, "AXIS CONTROL<br>FUNCTIONS"          |
| Synchronous, Composite and Superimposed control by program command | G51.4,<br>G51.5,<br>G51.6,<br>G50.5 | G51.4,<br>G51.5,<br>G51.6,<br>G50.5 | G51.4,<br>G51.5,<br>G51.6,<br>G50.5 | G51.4,<br>G51.5,<br>G51.6,<br>G50.5 | - CONNECTION MANUAL (FUNCTION)<br>"MULTI-PATH CONTROL"<br>- OPERATOR'S MANUAL (Common to<br>T/M Series) II. PROGRAMMING,<br>"MULTI-PATH CONTROL FUNCTION" |
| Flexible path axis assignment                                      | G52.1,<br>G52.2,<br>G52.3           | G52.1,<br>G52.2,<br>G52.3           | G52.1,<br>G52.2,<br>G52.3           | G52.1,<br>G52.2,<br>G52.3           | CONNECTION MANUAL (FUNCTION)<br>"AXIS CONTROL"  |
| High-speed G53 function  | G53                                 | G53                                 | G53                                 | G53                                 | - CONNECTION MANUAL (FUNCTION)<br>"AXIS CONTROL"<br>- OPERATOR'S MANUAL (Common to<br>T/M Series) II. PROGRAMMING,<br>"COORDINATE SYSTEM"                 |
| Workpiece coordinate system  | G54<br><br>(G54.1)                  | G54<br><br>(G54.1)                  | G54<br><br>(G54.1)                  | G54<br><br>(G54.1)                  | - CONNECTION MANUAL (FUNCTION)<br>"AXIS CONTROL"<br>- OPERATOR'S MANUAL (Common to<br>T/M Series) II. PROGRAMMING,<br>"COORDINATE SYSTEM"                 |
| Custom macro   | G65,<br>G66,<br>G66.1               | G65,<br>G66,<br>G66.1               | G65,<br>G66,<br>G66.1               | G65,<br>G66,<br>G66.1               | OPERATOR'S MANUAL (Common to T/M<br>Series) II. PROGRAMMING, "CUSTOM<br>MACRO"  |
| Execution macro (Note1)  | G65,<br>G66,<br>G66.1<br>Note1)     | G65,<br>G66,<br>G66.1<br>Note1)     | G65,<br>G66,<br>G66.1<br>Note1)     | G65,<br>G66,<br>G66.1<br>Note1)     | Macro Executor PROGRAMMING<br>MANUAL<br>"EXECUTION MACRO FUNCTION"  |
| Pattern Data Input   | G65                                 | G65                                 | G65                                 | G65                                 | - CONNECTION MANUAL (FUNCTION)<br>"PROGRAM COMMAND"<br>- OPERATOR'S MANUAL (Common to<br>T/M Series) II. PROGRAMMING,<br>"PATTERN DATA INPUT"             |
| Balanced cutting   | -                                   | G68                                 | G68                                 | G68                                 | - CONNECTION MANUAL (FUNCTION)<br>"MULTI-PATH CONTROL"<br>- OPERATOR'S MANUAL (For T Series)<br>II. PROGRAMMING, "BALANCE CUT"                            |
| Tilted working plane indexing                                      | G68.2                               | -                                   | -                                   | -                                   | - CONNECTION MANUAL (FUNCTION)<br>"PROGRAM COMMAND"<br>- OPERATOR'S MANUAL (For M Series)<br>II. PROGRAMMING, "FUNCTIONS TO<br>SIMPLIFY PROGRAMMING"      |

**B. LIST OF FUNCTIONS INCLUDE  
ADDRESS P IN THE PROGRAM  
COMMAND**

**APPENDIX**

B-64604EN-1/01

| Function name   | Machining center system | Lathe system                                       |  |  | Reference item  |
|---|-------------------------|--|--|--|---|
|   |                         | G code system                                      |  |  |   |
|   |                         | A  | B  | C  |   |
| Tilted working plane indexing by tool axis direction      | G68.3,                  | -  | -  | -  | - CONNECTION MANUAL (FUNCTION) "PROGRAM COMMAND"<br>- OPERATOR'S MANUAL (For M Series) II. PROGRAMMING, "FUNCTIONS TO SIMPLIFY PROGRAMMING"   |
| Tilted working plane indexing (incremental multi-command) | G68.4                   | -  | -  | -  | - CONNECTION MANUAL (FUNCTION) "PROGRAM COMMAND"<br>- OPERATOR'S MANUAL (For M Series) II. PROGRAMMING, "FUNCTIONS TO SIMPLIFY PROGRAMMING"   |
| Multiple repetitive cycles                                | -                       | G70 to G76   | G70 to G76   | G72 to G78   | - CONNECTION MANUAL (FUNCTION) "PROGRAM COMMAND"<br>- OPERATOR'S MANUAL (For T Series) II. PROGRAMMING, "FUNCTIONS TO SIMPLIFY PROGRAMMING"   |
| Figure copying  | G72.1, G72.2            | -  | -  | -  | OPERATOR'S MANUAL (Common to T/M Series) II. PROGRAMMING, "FUNCTIONS TO SIMPLIFY PROGRAMMING"   |
| Canned cycle  | G74, G76                | -  | -  | -  | OPERATOR'S MANUAL (For M Series) II. PROGRAMMING, "FUNCTIONS TO SIMPLIFY PROGRAMMING"   |
| Canned cycle for grinding                                 | G75, G77, G78, G79      | G72, G74   | G72, G74   | G73, G75   | - OPERATOR'S MANUAL (For T Series) II. PROGRAMMING, "FUNCTIONS TO SIMPLIFY PROGRAMMING"<br>- OPERATOR'S MANUAL (For M Series) II. PROGRAMMING, "FUNCTIONS TO SIMPLIFY PROGRAMMING"  |
| Canned cycle  | G82 to G84, G87 to G89  | G82 to G85, G87 to G89, G83.5, G83.6, G87.5, G87.6 | G82 to G85, G87 to G89, G83.5, G83.6, G87.5, G87.6 | G82 to G85, G87 to G89, G83.5, G83.6, G87.5, G87.6 | - OPERATOR'S MANUAL (For T Series) II. PROGRAMMING, "FUNCTIONS TO SIMPLIFY PROGRAMMING" and "MEMORY OPERATION USING Series 10/11 FORMAT"<br><br>- OPERATOR'S MANUAL (For M Series) II. PROGRAMMING, "FUNCTIONS TO SIMPLIFY PROGRAMMING"       |
| Electronic gear box                                       | G81                     | -  | -  | -  | CONNECTION MANUAL (FUNCTION) "AXIS CONTROL"   |
| High-speed peck drilling cycle                            | -                       | G83.1  | G83.1  | G83.1  | OPERATOR'S MANUAL (For T Series) II. PROGRAMMING, "FUNCTIONS TO SIMPLIFY PROGRAMMING"   |
| Rigid tapping cycle (FS10/11 format)                      | G84.2                   | G84.2  | G84.2  | G84.2  | - CONNECTION MANUAL (FUNCTION) "SPINDLE SPEED FUNCTION"<br>- OPERATOR'S MANUAL (For T Series) II. PROGRAMMING, "FUNCTIONS TO SIMPLIFY PROGRAMMING"<br>- OPERATOR'S MANUAL (For M Series) II. PROGRAMMING, "FUNCTIONS TO SIMPLIFY PROGRAMMING" |

**B. LIST OF FUNCTIONS INCLUDE  
ADDRESS P IN THE PROGRAM  
COMMAND**

B-64604EN-1/01

APPENDIX

| Function name                                    | Machining center system | Lathe system   |                |                | Reference item   |
|--|-------------------------|----------------|----------------|----------------|--|
|  |                         | G code system  |                |                |  |
|  |                         | A              | B              | C              |  |
| Left-handed rigid tapping cycle (FS10/11 format) | G84.3                   | -              | -              | -              | - CONNECTION MANUAL (FUNCTION) "SPINDLE SPEED FUNCTION"<br>- OPERATOR'S MANUAL (For M Series) II. PROGRAMMING, "FUNCTIONS TO SIMPLIFY PROGRAMMING" |
| Constant surface speed control                   | G96                     | G96            | G96            | G96            | - CONNECTION MANUAL (FUNCTION) "SPINDLE SPEED FUNCTION"<br>- OPERATOR'S MANUAL (Common to T/M Series) II. PROGRAMMING, "SPINDLE SPEED FUNCTION"    |
| Spindle Indexing Function                        | G96.1 to G96.3          | G96.1 to G96.3 | G96.1 to G96.3 | G96.1 to G96.3 | - CONNECTION MANUAL (FUNCTION) "SPINDLE SPEED FUNCTION"<br>- OPERATOR'S MANUAL (Common to T/M Series) II. PROGRAMMING, "SPINDLE SPEED FUNCTION"    |
| Spindle control with servo motor                 | G96.4                   | G96.4          | G96.4          | G96.4          | - CONNECTION MANUAL (FUNCTION) "SPINDLE SPEED FUNCTION"<br>- OPERATOR'S MANUAL (Common to T/M Series) II. PROGRAMMING, "SPINDLE SPEED FUNCTION"    |

Note 1) : Arbitrary G code is optional with the following compilation parameter.

- No.9013 to No.9022, No.9034, No.9045 to No.9047, No.9129 to No.9137

## B.2 LIST OF FUNCTIONS INCLUDE ADDRESS P IN THE ARGUMENT OF M AND S CODE

The function including address P in the argument of M and S code is shown below.

| Function name  | M code format | related parameters                               | Reference item   |
|--|---------------|--|--|
| Waiting M codes  | M_P_          | No.8110, No.8111, MWP(No.8103#1)                 | - CONNECTION MANUAL (FUNCTION) "MULTI-PATH CONTROL"<br>- OPERATOR'S MANUAL (Common to T/M Series) II. PROGRAMMING, "MULTI-PATH CONTROL FUNCTION" |
| Waiting M codes of high-speed Type   | M_P_          | No.8114, No.8115, MWP(No.8103#1)                 | - CONNECTION MANUAL (FUNCTION) "MULTI-PATH CONTROL"<br>- OPERATOR'S MANUAL (Common to T/M Series) II. PROGRAMMING, "MULTI-PATH CONTROL FUNCTION" |
| Waiting function by specifying start point   | M_P_L_IP      | STW(No.8101#1), No.8110, No.8111, MWP(No.8103#1) | - CONNECTION MANUAL (FUNCTION) "MULTI-PATH CONTROL"<br>- OPERATOR'S MANUAL (Common to T/M Series) II. PROGRAMMING, "MULTI-PATH CONTROL FUNCTION" |
| (Custom macro) Subprogram  | M98P_         |  | OPERATOR'S MANUAL (Common to T/M Series) III. PROGRAMMING, "PROGRAM CONFIGURATION"   |
| Program end  | M99P_         |  |  |
| External subprogram call   | M198P_        | SBP(No.3404#2)                                   | OPERATOR'S MANUAL (Common to T/M Series) III. OPERATION, "AUTOMATIC OPERATION"   |
| Custom macro Macro Call Using an M code ( include specification of multiple definitions and special macro call)    | M_P_          | MAA(No.6009#2)                                   | OPERATOR'S MANUAL (Common to T/M Series) II. PROGRAMMING, "CUSTOM MACRO"   |
| Execution macro Subprogram call  | M98P_         |  | Macro Executor PROGRAMMING MANUAL "EXECUTION MACRO FUNCTION"   |
| Subprogram call for user program   | M_P_          |  |  |
| Execution macro Macro Call Using an M code ( include specification of multiple definitions and special macro call) | M_P_          |  |  |
| Multi-spindle  | S_P_          | MPP(No.3703#3), No.3781                          | CONNECTION MANUAL (FUNCTION) "SPINDLE SPEED FUNCTION"  |

# INDEX

## <Number>

|                                |     |
|--------------------------------|-----|
| 2nd Geometry Tool Offset ..... | 148 |
| 4th/5th Axis Offset.....       | 150 |

## <A>

|   |     |
|---|-----|
| Addition of M Code for Clamp/Unclamp in Canned<br>Cycle for Drilling with ..... | 102 |
| ADDRESSES AND SPECIFIED RANGE FOR Series<br>10/11 PROGRAM FORMAT .....          | 231 |
| AUTOMATIC TOOL OFFSET (G36, G37).....   | 228 |
| AXIS CONTROL FUNCTIONS .....  | 298 |

## <B>

|                             |     |
|-----------------------------|-----|
| BALANCE CUT (G68, G69)..... | 303 |
| Boring Cycle (G85).....     | 295 |
| Boring Cycle (G89).....     | 296 |

## <C>

|   |         |
|---|---------|
| CANNED CYCLE .....  | 232     |
| CANNED CYCLE (G90, G92, G94) .....                                  | 34      |
| Canned Cycle and Tool Nose Radius Compensation                      | 47,245  |
| Canned Cycle Cancel (G80).....                                      | 116     |
| CANNED CYCLE FOR DRILLING.....                                      | 90,283  |
| Canned Cycle for Drilling Cancel (G80) .....                        | 102,297 |
| CANNED GRINDING CYCLE (FOR GRINDING<br>MACHINE).....                | 119     |
| CHAMFERING AND CORNER R .....                                       | 129     |
| Chuck and Tail Stock Barriers .....                                 | 348     |
| CIRCULAR THREADING (G35, G36) .....                                 | 28      |
| COMPENSATION FUNCTION.....  | 142     |
| CONSTANT LEAD THREADING (G32) .....                                 | 24      |
| CONTINUOUS THREADING.....   | 31      |
| CORNER CIRCULAR INTERPOLATION (G39).....                            | 223     |
| Counter Input of Offset value.....                                  | 329     |
| Cutter or Tool Nose Radius Compensation for Input<br>from MDI ..... | 220     |

## <D>

|   |     |
|---|-----|
| DATA INPUT/OUTPUT .....                                     | 307 |
| DATA TYPE.....  | 408 |
| DEFINITION OF WARNING, CAUTION, AND<br>NOTE .....           | s-1 |
| DESCRIPTION OF PARAMETERS.....                              | 359 |
| DETAILS OF CUTTER OR TOOL NOSE RADIUS<br>COMPENSATION ..... | 171 |
| DIRECT DRAWING DIMENSION PROGRAMMING<br>.....               | 136 |
| Direct Input of Tool Offset Value .....                     | 324 |
| Direct Input of Tool Offset Value Measured B .....          | 327 |
| Direction of Imaginary Tool Nose .....                      | 155 |
| Drilling Cycle, Counter Boring (G82) .....                  | 289 |
| Drilling Cycle, Spot Drilling Cycle (G81) .....             | 288 |

## <E>

|   |        |
|---|--------|
| End Face Peck Drilling Cycle (G74)..... | 78,271 |
|---|--------|

|                                   |        |
|-----------------------------------|--------|
| End Face Turning Cycle (G94)..... | 43,241 |
| EXTENDED TOOL SELECTION .....     | 225    |
| Extraction override.....          | 116    |

## <F>

|  |        |
|--|--------|
| Face cutting cycle .....   | 43,241 |
| Finishing Cycle (G70).....   | 74,267 |
| Front Boring Cycle (G85) / Side Boring Cycle (G89) .                               | 101    |
| Front Drilling Cycle (G83)/Side Drilling Cycle (G87) ..                            | 93     |
| Front Face Rigid Tapping Cycle (G84) / Side Face Rigid<br>Tapping Cycle (G88)..... | 107    |
| Front Tapping Cycle (G84) / Side Tapping Cycle (G88)<br>.....                      | 97     |
| FUNCTIONS TO SIMPLIFY PROGRAMMING .....  | 34     |

## <G>

|   |      |
|---|------|
| GENERAL .....   | 3,11 |
| GENERAL FLOW OF OPERATION OF CNC<br>MACHINE TOOL..... | 5    |
| GENERAL WARNINGS AND CAUTIONS .....                   | s-2  |

## <H>

|   |     |
|---|-----|
| High-speed Peck Drilling Cycle (G83.1) .....  | 287 |
| How to Use Canned Cycles.....                 | 244 |
| How to Use Canned Cycles (G90, G92, G94)..... | 45  |

## <I>

|  |         |
|--|---------|
| Imaginary Tool Nose .....  | 153     |
| INPUT/OUTPUT ON EACH SCREEN .....  | 307     |
| INPUT/OUTPUT ON THE ALL IO SCREEN.....                                   | 314     |
| Inputting 4th/5th axis offset data.....                                  | 311     |
| Inputting and Outputting 4th/5th Axis Offset Data .....                  | 311     |
| Inputting and Outputting Tool Offset / 2nd Geometry<br>Data .....        | 309     |
| Inputting and Outputting Tool Offset / 2nd Geometry<br>Tool Offset ..... | 316     |
| Inputting and Outputting Y-axis Offset Data .....                        | 307,315 |
| Inputting tool offset / 2nd geometry data.....                           | 309     |
| Inputting Y-axis offset data.....  | 307     |
| Interference Check .....   | 209     |
| Interference check alarm function.....                                   | 213     |
| Interference check avoidance function.....                               | 215     |
| INTERPOLATION FUNCTION .....   | 16      |

## <L>

|   |     |
|---|-----|
| LIST OF FUNCTIONS INCLUDE ADDRESS P IN<br>THE ARGUMENT OF G CODE .....      | 410 |
| LIST OF FUNCTIONS INCLUDE ADDRESS P IN<br>THE ARGUMENT OF M AND S CODE..... | 414 |
| LIST OF FUNCTIONS INCLUDE ADDRESS P IN<br>THE PROGRAM COMMAND .....         | 410 |

## <M>

|   |     |
|---|-----|
| MEMORY OPERATION USING Series 10/11<br>FORMAT ..... | 231 |
|---|-----|

|   |         |   |               |
|---|---------|---|---------------|
| MIRROR IMAGE FOR DOUBLE TURRET (G68, G69).....  | 135     | RIGID TAPPING.....  | 106           |
| MULTI-PATH CONTROL FUNCTION.....  | 303     | <b>&lt;S&gt;</b>  |               |
| MULTIPLE REPETITIVE CANNED CYCLE.....   | 249     | SAFETY PRECAUTIONS.....   | S-1           |
| MULTIPLE REPETITIVE CANNED CYCLE (G70-G76).....   | 51      | SCREENS DISPLAYED BY FUNCTION KEY  |               |
| MULTIPLE THREADING.....   | 32      | .....   | 319           |
| Multiple Threading Cycle (G76).....   | 82,275  | SETTING AND DISPLAYING DATA.....  | 319           |
| <b>&lt;N&gt;</b>  |         | Setting and Displaying the Tool Offset Value.....   | 319           |
| NOTES ON READING THIS MANUAL.....   | 6       | Setting the 4th/5th Axis Offset.....  | 343           |
| Notes on Tool Nose Radius Compensation.....   | 162     | Setting the Workpiece Coordinate System Shift Value.....  | 330           |
| NOTES ON VARIOUS KINDS OF DATA.....   | 7       | Setting the Y-Axis Offset.....  | 337           |
| <b>&lt;O&gt;</b>  |         | Setting Tool Offset / 2nd Geometry Tool Offset Values.....  | 334           |
| OFFSET.....   | 11,144  | STANDARD PARAMETER SETTING TABLES.....  | 409           |
| Offset Number.....  | 144     | Stock Removal in Facing (G72).....  | 66,260        |
| Offset Number and Offset Value.....   | 156     | Stock Removal in Turning (G71).....   | 52,250        |
| Operation to be performed if an interference is judged to occur.....                    | 213     | Straight cutting cycle.....   | 35,233        |
| Oscillation Direct Constant-Size Grinding Cycle (G74).....                              | 127     | Straight threading cycle.....   | 37,235        |
| Oscillation Grinding Cycle (G73).....   | 125     | SUBPROGRAM CALLING.....   | 231           |
| Outer Diameter / Internal Diameter Drilling Cycle (G75).....                            | 80,273  | Support of arbitrary axes for Y axis offset.....  | 147           |
| Outer Diameter/Internal Diameter Cutting Cycle (G90).....                               | 35,233  | <b>&lt;T&gt;</b>  |               |
| Outputting 4th/5th Axis Offset Data.....  | 312     | T Code for Tool Offset.....   | 143           |
| Outputting tool offset / 2nd geometry data.....   | 310     | Taper cutting cycle.....  | 36,44,234,242 |
| Outputting Y-axis Offset Data.....  | 308     | Taper threading cycle.....  | 40,238        |
| Override during Rigid Tapping.....  | 116     | Tapping Cycle (G84).....  | 292           |
| Override signal.....  | 117     | Tapping Cycle (G84.2).....  | 293           |
| Overview.....   | 171     | Threading Cycle (G92).....  | 37,235        |
| OVERVIEW OF CUTTER COMPENSATION (G40-G42).....  | 165     | Tool Geometry Offset and Tool Wear Offset.....  | 142           |
| OVERVIEW OF TOOL NOSE RADIUS COMPENSATION (G40-G42).....                                | 153     | Tool Movement in Offset Mode.....   | 181           |
| <b>&lt;P&gt;</b>  |         | Tool Movement in Offset Mode Cancel.....  | 200           |
| PARAMETERS.....   | 359     | Tool Movement in Start-up.....  | 175           |
| Pattern Repeating (G73).....  | 70,264  | TOOL OFFSET.....  | 142           |
| Peck Drilling Cycle (G83).....  | 290     | Tool Selection.....   | 144           |
| Peck Rigid Tapping Cycle (G84 or G88).....  | 112     | Traverse Direct Constant-Size Grinding Cycle (G72).....   | 123           |
| POLAR COORDINATE INTERPOLATION (G12.1, G13.1).....                                      | 16      | Traverse Grinding Cycle (G71).....  | 121           |
| POLYGON TURNING (G50.2, G51.2).....   | 298     | <b>&lt;V&gt;</b>  |               |
| Precautions to be Taken by Operator.....  | 105,297 | VARIABLE LEAD THREADING (G34).....  | 27            |
| PREPARATORY FUNCTION (G FUNCTION).....  | 12      | VECTOR RETENTION (G38).....   | 222           |
| Prevention of Overcutting Due to Cutter or Tool Nose Radius Compensation.....           | 206     | <b>&lt;W&gt;</b>  |               |
| <b>&lt;R&gt;</b>  |         | WARNINGS AND CAUTIONS RELATED TO HANDLING.....  | s-5           |
| Reducing of Waiting Time of Spindle Speed Arrival in the Canned Cycle for Drilling..... | 103     | WARNINGS AND CAUTIONS RELATED TO PROGRAMMING.....   | s-3           |
| Restrictions on Canned Cycles.....  | 48,246  | WARNINGS RELATED TO DAILY MAINTENANCE.....  | s-7           |
| Restrictions on Multiple Repetitive Canned Cycle.....                                   | 281     | Workpiece Position and Move Command.....  | 157           |
| Restrictions on Multiple Repetitive Canned Cycle (G70-G76).....                         | 87      | <b>&lt;Y&gt;</b>  |               |
| REVISION RECORD.....  | 1       | Y-Axis Offset.....  | 147           |

# REVISION RECORD

| Edition | Date       | Contents |
|---------|------------|----------|
| 01      | Sep., 2014 |          |

**B-64604EN-1/01**



\* B - 6 4 6 0 4 E N - 1 / 0 1 \*